

VALO'MARNE

RAPPORT ANNUEL D'ACTIVITE

Année 2019



Sommaire

- 1. Tonnages**
 - 1.1. Apports déchets ménagers du Syndicat
 - 1.2. Déchets réceptionnés
 - 1.3. Répartition des apports par origine
 - 1.4. Tonnages incinérés
- 2. Bilan énergétique global et évaluation du pouvoir calorifique inférieur**
- 3. Contrôle continu**
 - 3.1. Ligne EMERAUDE N°1**
 - 3.1.1. Mesure en continu des flux de polluants
 - 3.1.2. Mesure en continu des concentrations en polluants
 - 3.1.3. Mesure en semi continu des dioxines et furanes
 - 3.2. Ligne EMERAUDE N°2**
 - 3.2.1. Mesure en continu des flux de polluants
 - 3.2.2. Mesure en continu des concentrations en polluants
 - 3.2.3. Mesure en semi continu des dioxines et furanes
 - 3.3. Ligne spécifique DAS**
 - 3.3.1. Mesure en continu des flux de polluants
 - 3.3.2. Mesure en continu des concentrations en polluants
 - 3.3.3. Mesure en semi continu des dioxines et furanes
 - 3.4. Effluents**
- 4. Bilan des mesures semestrielles**
- 5. Analyses EMERAUDE**
 - 5.1. Analyses mâchefers
 - 5.2. Analyses cendres
 - 5.3. Analyses boues (gâteaux de filtre presse)
- 6. Analyses DAS**
 - 6.1. Analyses cendres
 - 6.2. Analyses boues (gâteaux de filtre presse)
- 7. Analyse légionnelles tours aéro : EMERAUDE et JACIR**
- 8. Consommation en eaux**
- 9. Analyse des rejets aqueux usine**
- 10. Fiches incidents**
- 11. Bilan de l'impact sur l'environnement**

1. Tonnages

1.1. Apports déchets ménagers du Syndicat

1.2. Déchets réceptionnés

1.3. Répartition des apports par origine

1.4. Tonnages incinérés

Recapitulatif des Tonnages réceptionnés

	2019					Σ trimestre		
	O. M. SYNDICAT	Autres OM et DAE	D.A.S.	TOTAL GENERAL	OM		DAE	DAS
JANVIER	15 270	5 222	1 298	21 790	43 816	17 160	3 910	64 887
FEVRIER	13 906	6 414	1 259	21 579				
MARS	14 640	5 525	1 353	21 518				
AVRIL	15 347	3 968	1 318	20 634				
MAI	15 333	1 978	1 352	18 663				
JUN	14 940	141	1 258	16 338	45 619	6 087	3 929	55 635
JUILLET	15 509	1 820	1 414	18 743				
AOUT	12 624	4 530	855	18 008				
SEPTEMBRE	14 356	4 937	1 178	20 471	42 490	11 287	3 447	57 223
OCTOBRE	15 018	5 592	1 325	21 935				
NOVEMBRE	14 699	4 172	1 210	20 080				
DECEMBRE	15 235	6 491	1 203	22 929	44 952	16 255	3 738	64 945
TOTAL RECEPTIONNE	176 877	50 788	15 024	242 689	176 877	50 788	15 024	242 689

Les tonnages indiqués peuvent légèrement varier d'un mois à l'autre suite à une mauvaise affectation du pesage ou suite à la contestation du poids.

D.A. E. et D. P. PAR DÉPARTEMENTS

Année 2019

Départements		JANV	FEV	MARS	AVRIL	MAI	JUN	JUIL	AOÛT	SEPT	OCT	NOV	DEC	TOTAL
68	RHÔNE						2,46							2,46
75	PARIS	18,76	7,94	17,90	7,50	42,90	5,40	11,96	21,96	9,48	17,56	12,04	12,02	185,42
77	SEINTE-ET-MARNE	59,86	59,70	46,38	61,50	26,08		89,92	75,96	501,76	37,56	32,42	31,12	1 016,26
78	YVELINES									118,94	373,24			492,18
91	ESSONNE	10,50	7,42	3,16	8,96	1,42	1,00	2,46	2,72	10,22	7,42	3,44	2,72	61,44
92	HAUTS-DE-SEINE	1 078,48	3 118,28	2 144,44	350,66	389,22	92,06	344,60	2 607,88	1 544,00	935,42	752,87	2 038,48	15 396,39
93	SEINE-ST-DENIS	750,74	603,34	589,24	639,64	345,58	10,62	376,28	426,80	626,32	752,40	635,06	747,68	6 503,70
94	VAL-DE-MARNE	3 307,54	2 614,78	2 721,48	2 684,74	1 141,70	25,66	965,16	1 357,94	1 893,28	3 321,86	2 635,38	3 471,72	26 341,26
95	VAL-D'OISE	2,30	2,20	1,96	15,32	30,76	3,54	29,34	36,30	233,24	146,20	100,54	187,46	769,16
		5 222,18	6 413,66	5 524,56	3 968,32	1 977,66	140,76	1 819,72	4 529,56	4 937,24	5 591,66	4 171,75	6 491,20	50 788,27

Répartition des apports des déchets par origine - 2019

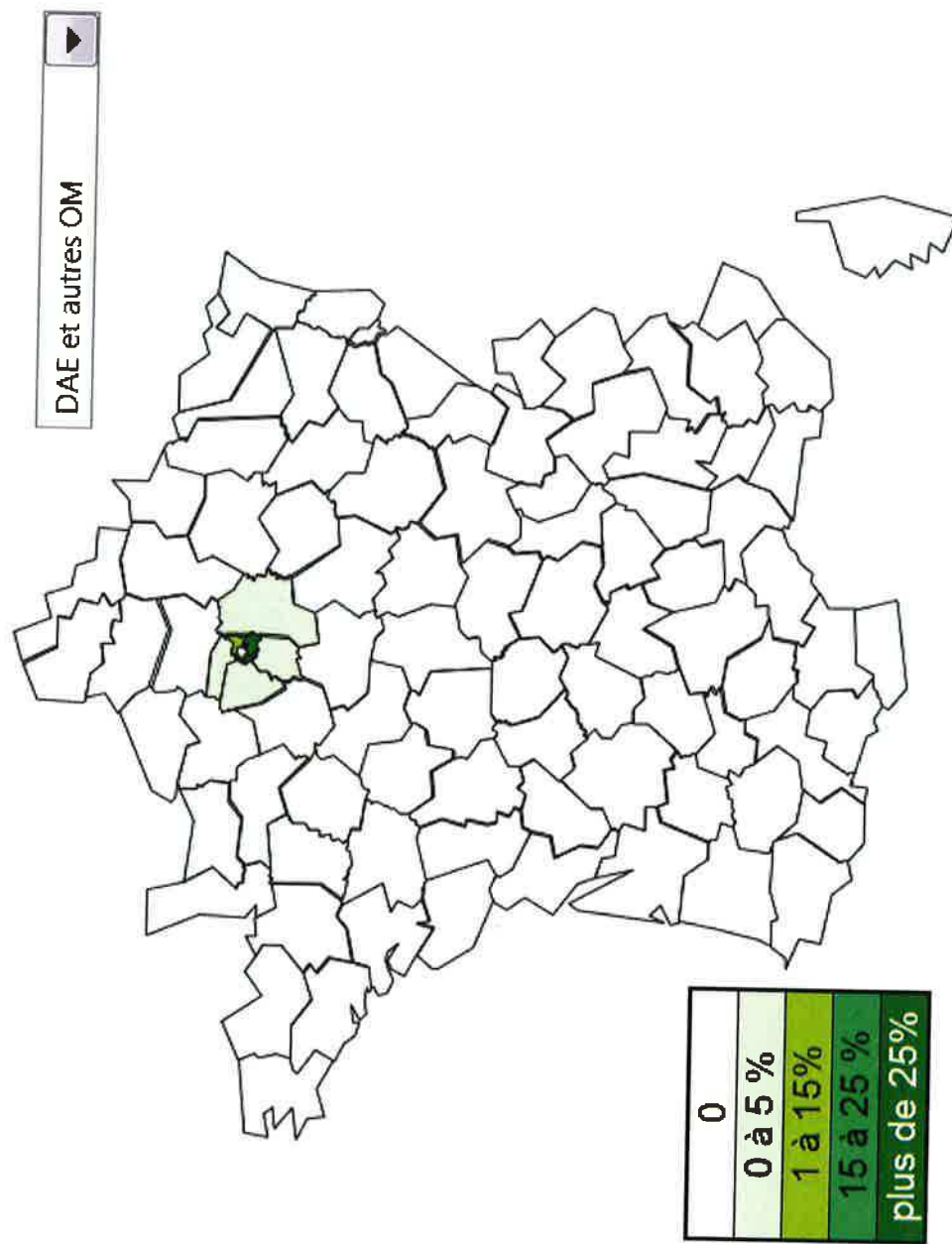

D.A.S.R.I. PAR DEPARTEMENTS

Année 2019

Départements		JANV	FEV	MARS	AVRIL	MAI	JUN	JUIL	AOÛT	SEPT	OCT	NOV	DEC	TOTAL
10	AUBE	27,64	21,66	20,40	23,92	20,52	8,08	6,68	11,70	11,70	11,80	7,92	3,92	165,84
51	MARNE	41,22	42,04	56,96	72,08	56,64	37,30	47,40	19,62	50,36	28,54	52,38	58,02	562,58
57	MOSSELLE						17,70							17,70
59	NORD					53,52								53,52
75	PARIS	546,65	531,54	575,19	551,00	553,44	528,21	670,20	446,62	542,19	622,31	567,02	607,52	6 743,88
77	SEINTE-ET-MARNE	18,96	17,86	18,09	17,81	18,47	18,04	18,71	14,70	18,04	19,97	18,62	19,43	218,69
78	YVELINES	161,07	157,39	168,97	154,50	146,64	131,05	200,44	93,59	119,63	141,06	109,02	101,12	1 664,48
91	ESSONNE	118,56	119,43	131,81	140,06	126,23	144,66	111,39	63,72	119,73	131,67	126,36	112,18	1 445,82
92	HAUTS-DE-SEINE	119,56	119,94	122,43	122,35	117,74	116,83	110,73	66,53	108,93	123,35	112,61	104,10	1 344,12
93	SEINTE-ST-DENIS	69,36	64,96	65,55	69,32	69,02	62,95	65,15	48,87	61,29	68,67	60,24	61,38	766,75
94	VAL-DE-MARNE	146,70	144,12	156,00	135,47	146,47	149,55	125,69	88,85	116,13	135,09	122,71	117,17	1 563,92
95	VAL-D'OISE	46,44	40,91	38,00	31,63	43,76	43,63	57,70	10,56	29,84	42,64	33,15	17,96	436,22
		1 298,18	1 258,84	1 353,41	1 318,14	1 352,44	1 258,00	1 414,07	854,66	1 177,83	1 325,09	1 210,05	1 202,81	15 023,51

0,47% % de DASRI provenant de plus de 150km à l'année

Répartition des apports des déchets par origine - 2019

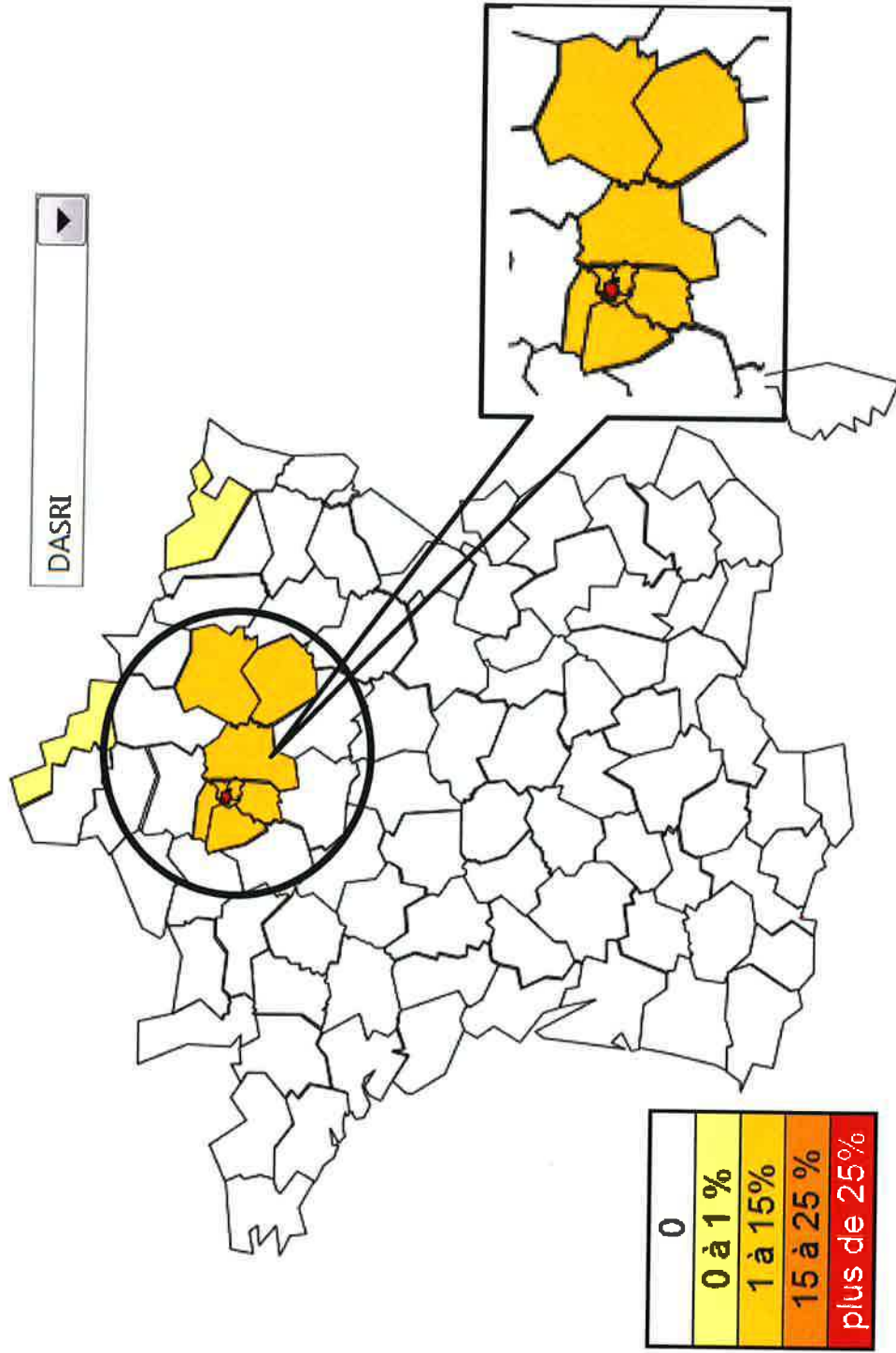

Ratio de répartition des collectes DASRI dans le rayon de 150km et au-delà :
0,47 % de DASRI au-delà des 150km

Recyclage et valorisation France

Tél. : +33 (0)1 48 98 99 91
 Fax : +33 (0)148 98 48 83
 Mob : +33 (0)6 74 82 29 44



VALOMARNE - 10-11 rue des Mallourches
 94034 Créteil Cedex - France

De : DEMEYER, Sylvain [mailto:sylvain.demeyer@esterra.fr]
 Envoyé : mardi 7 mai 2019 15:20
 À : Blanfune, Benjamin <benjamin.blanfune@suez.com>; Vigneron, Sebastien <sebastien.vigneron@suez.com>
 Cc : Benoit CASTERMAN <benoit.casterman@esterra.fr>; Stéphane CAPLIER <stephane.caplier@esterra.fr>; Christophe DELECOURT <christophe.delecourt@esterra.fr>; Georges L'OFFREDO <georges.loffredo@esterra.fr>; Frederic DUFEDEL <frederic.dufedel@esterra.fr>; Christelle HUYGHE <christelle.huyghe@esterra.fr>
 Objet : Re: demande pour délestages DASRI - semaine 20

Bonjour M. Blanfune,

Je me permets de revenir vers vous concernant notre besoin de la semaine prochaine. L'exutoire régional que nous avons sollicité ne pourra pas nous aider pour les journées du 18, 19 et 20 mai. Aussi, je vous prie de trouver ci-joint notre proposition de planning de nos apports avec sur ligné en rouge les créneaux supplémentaires demandés.

Valo/Marne / Créteil	dimanche	lundi	mardi	mercredi	jeudi	vendredi	samedi
38 GRV	10h00	11h30	11h30	11h30	11h30	11h30	10h00
44 GRV		19h30	15h30	15h30	15h30	15h30	
38 GRV		23h30					

Je vous remercie d'avance pour votre collaboration.

Dans l'attente de votre confirmation.

Bien cordialement,

esterra
 Sylvain Demeyer
 Responsable d'Exploitation
 DASRI/DID/DDS - Propreté
 Fon: 0609146589
 M: 0320785281

Le lun. 6 mai 2019 à 12:36, DEMEYER, Sylvain <sylvain.demeyer@esterra.fr> a écrit :

Bonjour Mr Blanfune,

Je me permets de revenir vers vous concernant notre sollicitation pour vous apporter des DASRI durant la semaine 20 du 13 au 20/05 et aussi le lundi 21/05.

Je vous prie de trouver ci-joint notre proposition de planning de nos apports durant cette période.

Valo/Marne / Créteil	lundi	mardi	mercredi	jeudi	vendredi	samedi	dimanche
38 GRV	11h30	11h30	11h30	11h30	11h30		
44 GRV	19h30	15h30	15h30	15h30	15h30		
38 GRV	23h30						

Je vous remercie d'avance pour votre aide et collaboration et je reste à votre disposition pour toute information complémentaire.

Dans l'attente de vous lire.

Bien cordialement,

esterra
 Sylvain Demeyer
 Responsable d'Exploitation
 DASRI/DID/DDS - Propreté
 Fon: 0609146589
 M: 0320785281

Le Jeu. 25 avr. 2019 à 12:57, DEMEYER, Sylvain <sylvain.demeyer@esterra.fr> a écrit :

Bonjour Mr Vigneron,

Je vous remercie de m'avoir rappelé.

Pour faire suite à notre conversation téléphonique, je vous confirme notre besoin de délestage 2 à 3 camions de 38 GRV de 770 L (modèle PlasticOmnium, cf pièces jointes) la semaine 20 soit du 13 au 18 mai prochain. Ces DASRI sont collectés dans des établissements des Hauts de France.

Avez-vous la possibilité de satisfaire à notre demande et sous quelle condition organisationnelle et financière ?

Je vous remercie d'avance pour l'intérêt que vous porterez à nos besoins et je reste à votre disposition pour tout complément d'information sur le sujet.

Cordialement,

esterra
 Sylvain Demeyer
 Responsable d'Exploitation
 DASRI/DID/DDS - Propreté
 Fon: 0609146589
 M: 0320785281

----- Forwarded message -----

De : DEMEYER, Sylvain <sylvain.demeyer@esterra.fr>
 Date: ven. 19 avr. 2019 à 10:25
 Subject: demande pour délestages DASRI - semaine 20
 To: <benjamin.blanfune@suez.com>

Bonjour Mr Blanfune,

Justificatif apports DASRI du Dpt 59 >15km (mai-2019)

Emery, Geraldine

De: KELLER, Joel <joel.keller@veolia.com>
 Envoyé: vendredi 14 juin 2019 10:02
 À: Viratelle, Marie-Christine; Blanfune, Benjamin; Emery, Geraldine
 Cc: Manuel HRUBE; David BOURGATTE
 Objet: Detournés DASRI

Bonjour,

Faisant suite à mon entretien téléphonique de ce jour avec Mr Blanfune, veuillez trouver ci après, un état des raisons pour lesquelles nous souhaitons apporter des DASRI dans votre établissement au cours de la semaine 26

Le prochain arrêt de l'usine Val'Ergle à Ludres (54) pour maintenance programmée se déroulera sur 3 semaines du 17 juin au 5 juillet pour la ligne n°1 avec en parallèle une semaine d'arrêt de la ligne n°2 du 24 au 28 juin afin de procéder aux contrôles réglementaires des équipements commun.

Au cours de cet arrêt des 2 lignes d'une durée de 5 jours nous devons procéder comme chaque année au déblayement des DASRI vers d'autres sites de traitement autorisés.

Habituellement nous faisons appel à 2 ou 3 sites régionaux ou* proches* parmi :

- UIOM suez de Tronville en barrois (Meuse Energie)
- UIOM Créteil suez
- UIOM Dijon en règle
- Trédi à Strasbourg

Nous besoins d'évacuation sont globalement de l'ordre de 200 bac par jour soit environ 18 t/jour

- UIOM de Tronville en Barrois ces derniers nous autorisent 90 bac/.
- UIOM de Dijon : refus
- Trédi Strasbourg : refus
- UIOM de Créteil : 70 bacs /jour : en attente de validation

Outre les 4 installations ci avant listées et compte tenu des besoins nous avons eu l'autorisation d'apporter un complément dasri sur 2 autre usines : dans un périmètre plus éloigné :

- Usine de BAYET dans département 03 pour 30 bac/.
- St ouen l'aumône dans le département 95 pour 30 bac/.

Nous avons également contacté d'autres incinérateurs mais sans résultat :

- UIOM du Mans : sont saturés
- Trédi à Lyon : retour négatif
- UIOM Veolia de Saran dans le Centre val de Loire : sont saturés

Dans ce contexte, l'UIOM de Créteil est le seul exutoire complémentaire qui permettrait de traiter les DASRI encore sans exutoire.

Espérant un accord positif

Cordialement

Joël KELLER

Directeur Secteur Tri-Traitement / Lorraine Sud
 RECYCLAGE & VALORISATION DES DECHETS

Centre de Valorisation des Déchets
 226, rue Victor Grignard - ZI - 54710 LUDRES
 tél.: +33 3 83 26 21 00 - fax : +33 3 83 26 12 33

www.veolia.com

Un devis, une prestation, un conseil ? Contactez notre Centre de Relation Client

serviceclient_rvd_rrh@veolia.com
 tél. 03 72 31 31 31 - fax 03 69 67 09 10
 du lundi au vendredi 8h 12h30 / 13h30-18h
 7 jours sur 7

Vous pouvez aussi demander la collecte de vos déchets en ligne sur votre Espace Client

This e-mail transmission (message and any attached files) may contain information that is proprietary, privileged and/or confidential to Veolia Environnement and/or its affiliates and is intended exclusively for the person(s) to whom it is addressed. If you are not the intended recipient, please notify the sender by return e-mail and delete all copies of this e-mail, including all attachments. Unless expressly authorized, any use, disclosure, publication, retransmission or dissemination of this e-mail and/or of its attachments is strictly prohibited.

Ce message électronique et ses fichiers attachés sont strictement confidentiels et peuvent contenir des éléments dont Veolia Environnement et/ou l'une de ses entités affiliées sont propriétaires. Ils sont donc destinés à l'usage de leurs seuls destinataires. Si vous avez reçu ce message par erreur, merci de le retourner à son émetteur et de le détruire ainsi que toutes les pièces attachées. L'utilisation, la divulgation, la publication, la distribution, ou la reproduction non expressément autorisées de ce message et de ses pièces attachées sont interdites.

Justificatif apports DASRI du Dpt 57 >150km (juin-2019)

2. Bilan énergétique global et évaluation du pouvoir calorifique inférieur

Valorisation énergétique VALO'MARNE année 2019 (type R1)

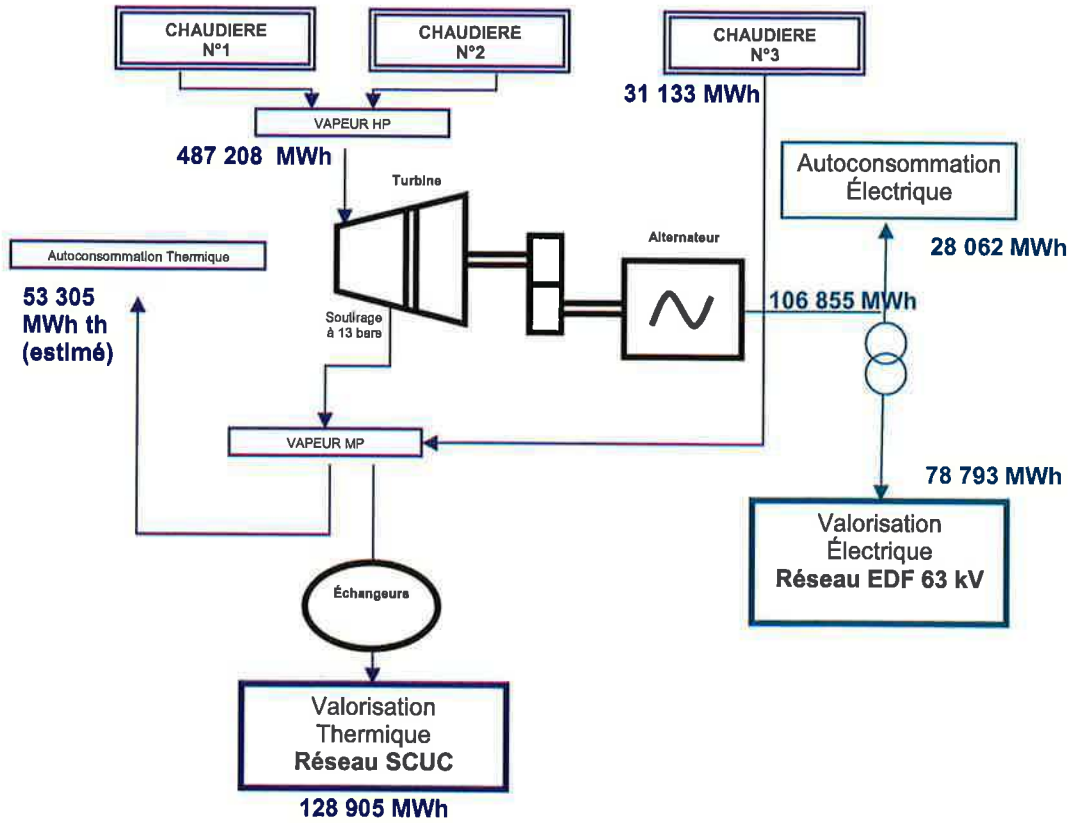

Une nouvelle formule de calcul est applicable dès 2016 (cf arrêté du 7 décembre 2016) :

$$Pe \text{ type R1} = \{ [Ep - (Ef + Ei)] / [0,97 \times (Ew + Ef)] \} \times FCC$$

$Ep = 2,6 \times \text{énergie électrique produite} + 1,1 \times \text{énergie thermique vendue} + 1,1 \times \text{énergie thermique auto-consommée}$

$Ef = \text{énergie importée sous forme de combustible (pour les brûleurs) et contribuant à la production de vapeur}$

$Ei = \text{énergie importée sous forme de combustible (pour les brûleurs) et ne contribuant pas à la production de vapeur} + 2,6 \times \text{électricité achetée}$

$Ew = \text{énergie apportée par les déchets (= tonnage incinéré} \times \text{PCI)}$

$FCC = \text{facteur de correction climatique}$

			Coef
Prod. Turbo	106 855	MWh	2,6
Energie thermique vendue	128 905	MWh	1,1
Thermique autoconsommés mesurée	0	MWh	1,1
Ep	419 619	MWh	
Conso gaz totale	39 494	MWh	
Dont gaz pour prod vapeur (estimé)	12 088	MWh	
Electricité achetée	738	MWh	2,6
Ef	12 088	MWh	
Ef + Ei	41 413	MWh	
Tonnage incinéré	232 548	Tonnes	
PCI	2 295	kcal/kg	
PCI	9,607	MJ/kg	4,186
Ew	620 572	MWh	
FCC (Station météo Saint-Maur)	1,25		
Ep - (Ef + Ei)	378 206	MWh	
0,97 x (Ew + Ef)	613 680	MWh	
Pe type R1	77,0%		

Les calculs effectués pour VALO'MARNE montrent pour l'année 2019 une efficacité énergétique R1 de **77,0 %**.

3. Contrôle continu

3.1. Ligne EMERAUDE N°1

- 3.1.1. Mesure en continu des flux de polluants**
- 3.1.2. Mesure en continu des concentrations en polluants**
- 3.1.3. Mesure en semi continu des dioxines et furanes**



Rapport DREAL Flux Mensuel Ligne 1

Rapport Flux Mensuel Flux Ligne 1 Janvier 2019

CO		COT		HCL		NOx		POUSSIERE		SO2		NH3		MarcheFourL1	
Unité	Kg	Kg	Kg	Kg	Kg	Kg	Kg	Kg	Kg	Kg	Kg	Kg	Kg	hh	mm:ss
VLE Jour	57.61	19.2	19.2	19.2	19.2	19.2	19.2	153.6	19.2	19.2	96	19.2	19.2		
01/01/2019	7.653	1.50	1.453	135.33	10.60	7.239	1.283							24:00:00	
02/01/2019	7.474	1.33	1.333	132.78	8.92	17.451	1.175							24:00:00	
03/01/2019	7.507	1.22	1.601	133.52	7.09	18.496	0.637							24:00:00	
04/01/2019	7.451	1.02	1.616	134.58	7.07	10.420	0.658							24:00:00	
05/01/2019	7.759	1.04	1.490	135.53	9.25	11.706	0.985							24:00:00	
06/01/2019	6.650	0.98	1.434	134.67	6.51	19.036	0.694							24:00:00	
07/01/2019	7.164	1.20	1.468	134.16	11.16	16.239	1.077							24:00:00	
08/01/2019	7.345	1.46	1.441	135.39	12.12	12.802	1.074							24:00:00	
09/01/2019	7.233	1.11	1.334	133.86	9.29	8.473	0.746							24:00:00	
10/01/2019	7.191	0.87	1.423	133.84	9.20	10.619	0.544							24:00:00	
11/01/2019	7.378	0.60	1.445	132.74	7.47	6.945	0.771							24:00:00	
12/01/2019	7.704	1.02	1.392	136.54	10.69	7.204	1.272							24:00:00	
13/01/2019	6.917	1.20	1.197	134.21	8.76	12.184	0.989							24:00:00	
14/01/2019	6.822	1.13	1.438	132.66	8.20	23.341	0.956							24:00:00	
15/01/2019	7.257	1.00	1.456	132.80	9.82	16.999	1.245							24:00:00	
16/01/2019	7.331	0.99	1.163	133.77	11.15	8.603	1.630							24:00:00	
17/01/2019	7.059	0.98	1.147	131.03	10.16	12.080	1.266							24:00:00	
18/01/2019	7.069	0.43	1.288	130.43	9.68	11.504	1.268							24:00:00	
19/01/2019	6.816	0.25	1.142	133.77	8.63	5.739	1.139							24:00:00	
20/01/2019	7.043	0.34	1.052	134.99	10.26	6.661	1.834							24:00:00	
21/01/2019	6.941	0.22	1.152	131.86	8.77	8.526	1.512							24:00:00	
22/01/2019	7.036	0.23	1.059	133.28	10.00	7.944	1.062							24:00:00	
23/01/2019	6.821	0.25	1.264	131.23	10.78	5.602	1.663							24:00:00	
24/01/2019	6.396	0.25	1.129	132.59	8.56	6.004	1.271							24:00:00	
25/01/2019	6.405	0.33	1.110	129.12	9.69	5.589	1.235							24:00:00	
26/01/2019	7.168	0.84	1.039	131.06	15.27	3.845	2.193							24:00:00	
27/01/2019	6.589	0.72	1.001	130.89	10.65	11.311	1.859							24:00:00	
28/01/2019	6.502	0.52	1.056	129.32	12.23	10.890	2.382							24:00:00	
29/01/2019	6.990	0.41	1.081	130.09	14.77	14.252	2.536							24:00:00	
30/01/2019	7.068	0.45	1.018	130.21	15.70	14.797	3.092							24:00:00	
31/01/2019	6.720	0.41	0.978	127.89	10.51	17.301	1.642							24:00:00	
Min	6.396	0.22	0.978	127.89	6.51	3.845	0.544								
Max	7.759	1.50	1.616	136.54	15.70	23.341	3.092								
Cumul	219.459	24.30	39.200	4115.14	312.96	349.802	41.690								31j 00:00:00
VLE Flux Jour	0	0	0	0	0	0	0								



Rapport DREAL Flux Mensuel Ligne 1

Rapport Flux Mensuel											Février 2019	
Flux Ligne 1												
CO	COT	HCL	NOX	POUSSIERE	SO2	NH3	MarcheFourL1					
Unité Kg	Kg	Kg	Kg	Kg	Kg	Kg	hh:mm:ss					
VLE Jour	57.61	19.2	19.2	153.6	19.2	96	19.2					
01/02/2019	11.219	0.87	1.058	123.33	15.69	57.798	1.594	23:59:50				
02/02/2019	7.660	0.56	1.553	128.21	16.03	46.040	1.048	24:00:00				
03/02/2019	6.845	0.42	1.529	132.38	11.22	10.377	0.749	24:00:00				
04/02/2019	6.909	0.32	1.529	132.06	7.83	21.967	0.487	24:00:00				
05/02/2019	7.774	0.47	1.864	134.54	14.49	11.908	0.417	24:00:00				
06/02/2019	8.134	0.69	1.745	133.47	13.30	7.854	0.558	24:00:00				
07/02/2019	7.658	1.09	1.742	134.61	10.73	8.952	0.557	24:00:00				
08/02/2019	8.505	1.14	1.724	132.76	9.71	7.296	0.588	24:00:00				
09/02/2019	8.280	1.18	1.759	131.46	11.08	9.259	0.827	24:00:00				
10/02/2019	7.401	1.06	1.618	132.99	10.62	14.869	0.727	24:00:00				
11/02/2019	10.870	0.79	1.642	132.07	13.24	24.158	1.211	24:00:00				
12/02/2019	7.415	0.54	1.522	132.97	8.49	15.179	0.569	24:00:00				
13/02/2019	7.679	0.36	1.399	135.13	10.16	7.195	3.800	24:00:00				
14/02/2019	6.781	0.63	1.395	128.32	13.81	5.099	0.802	24:00:00				
15/02/2019	6.107	0.92	1.247	126.18	12.87	3.445	1.333	24:00:00				
16/02/2019	6.987	1.26	1.150	129.25	14.83	3.486	2.299	24:00:00				
17/02/2019	6.783	1.49	1.077	130.52	15.79	4.214	2.975	24:00:00				
18/02/2019	6.540	1.25	0.979	133.61	9.26	4.049	3.114	24:00:00				
19/02/2019	6.679	1.10	1.166	132.22	11.07	5.099	2.675	24:00:00				
20/02/2019	8.132	0.52	0.921	126.50	9.71	6.483	2.421	24:00:00				
21/02/2019	7.275	0.00	1.029	133.86	15.16	3.188	2.286	24:00:00				
22/02/2019	7.863	0.31	1.213	132.70	11.08	2.979	1.494	24:00:00				
23/02/2019	7.320	0.36	1.139	135.01	9.03	2.891	1.688	24:00:00				
24/02/2019	6.832	0.15	1.212	135.02	9.06	4.213	1.195	24:00:00				
25/02/2019	6.738	0.18	1.523	133.51	11.10	5.820	0.788	24:00:00				
26/02/2019	6.929	0.35	1.715	133.82	10.00	6.890	0.814	24:00:00				
27/02/2019	7.114	0.44	1.687	131.69	11.35	5.514	1.045	24:00:00				
28/02/2019	6.555	0.34	1.469	134.48	8.22	4.570	1.319	24:00:00				
Min	6.107	0.00	0.921	123.33	7.83	2.891	0.417					
Max	11.219	1.49	1.864	135.13	16.03	57.798	3.800					
Cumul	210.984	18.79	39.606	3692.67	324.93	310.792	39.380	27j 23:59:50				
VLE Flux Jour	0	0	0	0	0	0	0					



Rapport DREAL Flux Mensuel Ligne 1

Rapport Flux Mensuel											Mars 2019	
Flux Ligne 1												
CO	COT	HCL	NOx	POUSSIÈRE	SO2	NH3	MarcheFourL1					
Unité Kg	Kg	Kg	Kg	Kg	Kg	Kg	hh:mm:ss					
VLE Jour	57,61	19,2	19,2	153,6	19,2	96	19,2					
01/03/2019	7.395	0.28	1.427	133.17	11.53	4.640	1.616	24:00:00				
02/03/2019	7.785	0.46	1.245	135.94	9.65	2.975	1.230	24:00:00				
03/03/2019	6.693	0.84	1.364	133.04	7.95	3.300	1.500	24:00:00				
04/03/2019	6.671	0.45	1.331	131.73	7.94	5.285	1.209	24:00:00				
05/03/2019	6.624	0.40	1.410	128.25	8.14	3.799	0.946	24:00:00				
06/03/2019	7.144	0.58	1.456	132.55	9.51	7.964	1.208	24:00:00				
07/03/2019	7.217	0.43	1.343	132.03	9.79	6.986	1.084	24:00:00				
08/03/2019	7.202	0.23	1.335	132.69	8.56	5.246	1.149	24:00:00				
09/03/2019	7.822	0.28	1.195	133.67	11.05	2.969	1.756	24:00:00				
10/03/2019	6.489	0.29	1.194	134.51	8.48	6.842	1.670	24:00:00				
11/03/2019	6.555	0.00	1.363	132.99	7.19	7.891	0.832	24:00:00				
12/03/2019	5.675	0.00	1.633	123.50	15.14	7.470	0.521	24:00:00				
13/03/2019	6.346	0.01	1.729	125.30	10.16	20.473	1.119	24:00:00				
14/03/2019	7.019	0.29	1.457	132.09	10.33	20.886	1.600	24:00:00				
15/03/2019	6.812	0.52	1.217	137.69	9.26	7.961	2.146	23:54:40				
16/03/2019	7.740	0.79	1.953	108.42	16.45	21.820	4.258	23:24:50				
17/03/2019	6.808	0.50	1.008	116.42	8.49	28.876	3.373	24:00:00				
18/03/2019	7.284	0.41	1.092	131.75	13.16	27.277	2.940	24:00:00				
19/03/2019	8.185	0.04	1.076	129.20	11.99	27.476	2.993	24:00:00				
20/03/2019	11.932	0.33	1.003	128.45	7.74	17.948	2.963	24:00:00				
21/03/2019	6.165	0.93	0.975	125.34	17.04	18.423	4.161	24:00:00				
22/03/2019	6.400	1.95	0.768	124.48	10.30	13.935	2.996	23:51:10				
23/03/2019	6.793	4.12	4.524	93.77	11.72	3.298	6.172	18:11:20				
24/03/2019	6.917	5.00	0.468	147.07	14.13	9.424	2.886	24:00:00				
25/03/2019	7.626	5.03	0.511	125.25	6.08	15.017	0.324	24:00:00				
26/03/2019	8.903	5.74	0.565	97.17	12.49	0.331	1.066	24:00:00				
27/03/2019	8.928	5.66	1.174	110.82	14.36	7.584	1.525	24:00:00				
28/03/2019	8.453	5.68	1.510	132.50	11.10	4.549	0.728	24:00:00				
29/03/2019	9.255	5.68	2.039	129.29	8.93	5.702	0.966	24:00:00				
30/03/2019	8.097	5.55	2.372	131.62	11.95	5.960	0.675	24:00:00				
31/03/2019	5.675	0.00	2.231	126.40	9.11	4.075	0.541	23:00:00				
Min	11.932	5.98	0.468	93.77	6.08	0.331	0.324	24:00:00				
Max	234.775	53.11	4.524	147.07	17.04	28.876	6.172	24:00:00				
Cumul	0	0	43.968	3937.10	329.72	326.382	58.153	30j 16:22:00				
VLE Flux Jour	0	0	0	0	0	0	0	0				



Rapport DREAL Flux Mensuel Ligne 1

Rapport Flux Mensuel											Avril 2019	
Flux Ligne 1												
CO	COT	HCL	NOx	POUSSIERE	SO2	NH3	MarcheFour.L					
Unité Kg	Kg	Kg	Kg	Kg	Kg	Kg	hh:mm:ss					
VLE Jour	57.61	19.2	19.2	153.6	19.2	96	19.2					
01/04/2019	12.718	5.94	1.952	134.37	10.60	2.943	1.766	24:00:00				
02/04/2019	8.859	6.36	1.795	129.66	9.88	0.399	0.850	24:00:00				
03/04/2019	9.135	6.92	1.710	130.76	11.75	0.250	0.782	24:00:00				
04/04/2019	8.410	6.31	1.732	125.04	17.16	1.860	0.507	24:00:00				
05/04/2019	7.611	5.61	0.976	123.56	10.32	0.042	1.079	24:00:00				
06/04/2019	6.996	5.59	0.496	122.94	13.27	0.000	1.319	24:00:00				
07/04/2019	6.008	5.22	0.456	117.33	9.33	0.207	1.157	24:00:00				
08/04/2019	6.639	5.54	0.505	121.32	8.93	0.446	1.137	24:00:00				
09/04/2019	7.180	6.03	0.675	122.38	13.65	0.851	1.786	24:00:00				
10/04/2019	10.846	6.42	0.574	119.19	7.33	1.895	1.097	24:00:00				
11/04/2019	7.422	6.87	0.975	118.35	7.51	2.237	0.507	24:00:00				
12/04/2019	8.185	7.31	1.401	125.87	8.20	0.193	0.684	24:00:00				
13/04/2019	7.960	6.86	1.203	129.44	12.05	0.661	0.880	24:00:00				
14/04/2019	6.816	6.07	0.547	129.94	8.41	0.370	0.788	24:00:00				
15/04/2019	7.183	2.88	0.830	129.58	16.44	3.669	1.595	24:00:00				
16/04/2019	6.753	0.00	0.680	133.88	11.73	5.454	2.120	24:00:00				
17/04/2019	7.073	0.00	0.724	129.35	10.80	4.885	1.641	24:00:00				
18/04/2019	7.325	0.00	0.928	131.03	10.63	1.364	1.302	24:00:00				
19/04/2019	6.023	0.00	0.602	129.66	6.60	2.260	1.498	24:00:00				
20/04/2019	18.524	0.01	0.531	130.46	12.19	7.597	1.838	24:00:00				
21/04/2019	6.203	0.00	0.466	132.47	11.67	9.111	2.299	24:00:00				
22/04/2019	7.303	0.00	0.455	132.42	11.39	4.326	2.575	24:00:00				
23/04/2019	6.552	0.00	0.442	132.86	9.30	6.241	3.065	24:00:00				
24/04/2019	6.035	0.00	0.444	130.22	7.95	7.855	2.757	24:00:00				
25/04/2019	6.982	0.00	0.445	131.15	8.72	7.040	1.803	24:00:00				
26/04/2019	6.982	0.06	0.461	130.77	11.05	5.292	2.323	24:00:00				
27/04/2019	6.950	0.59	0.463	130.47	12.37	4.939	3.482	24:00:00				
28/04/2019	6.589	0.54	0.477	133.39	12.15	7.616	3.904	24:00:00				
29/04/2019	6.399	0.11	0.467	129.94	8.71	4.791	2.302	24:00:00				
30/04/2019	7.285	0.38	0.447	145.90	6.28	3.095	2.110	24:00:00				
Min	6.008	0.00	0.442	117.33	6.28	0.000	0.507	24:00:00				
Max	18.524	7.31	1.952	145.90	17.16	9.111	3.904	24:00:00				
Cumul	234.946	91.62	23.859	3863.70	316.37	97.889	50.953	30j 00:00:00				
VLE Flux Jour	0	0	0	0	0	0	0	0				



Rapport DREAL Flux Mensuel Ligne 1

Rapport Flux Mensuel											Mai 2019	
Flux Ligne 1												
CO	COT	HCL	NOx	POUSSIERE	SO2	NH3	MarcheFourL1					
Unité Kg	Kg	Kg	Kg	Kg	Kg	Kg	hh:mm:ss					
VLE Jour	57.61	19.2	19.2	153.6	19.2	96	19.2					
01/05/2019	7.510	0.55	0.732	120.37	12.36	2.710	2.634	24:00:00				
02/05/2019	7.789	0.89	0.791	123.42	9.00	5.521	2.542	24:00:00				
03/05/2019	8.024	1.13	0.776	124.87	9.96	4.690	3.016	24:00:00				
04/05/2019	6.703	1.50	2.877	100.86	14.22	1.903	2.073	19:50:20				
05/05/2019	8.022	1.61	0.962	122.72	13.79	4.767	3.221	24:00:00				
06/05/2019	8.193	1.51	0.931	123.86	11.42	5.331	3.706	24:00:00				
07/05/2019	8.020	2.02	0.871	121.02	14.59	2.008	4.241	24:00:00				
08/05/2019	8.047	2.12	0.836	122.60	13.20	3.681	4.633	24:00:00				
09/05/2019	7.375	2.39	0.767	126.06	7.37	7.032	3.026	24:00:00				
10/05/2019	8.958	1.80	0.675	146.76	7.68	6.841	2.922	24:00:00				
11/05/2019	7.943	1.55	0.693	138.33	8.58	5.616	2.556	24:00:00				
12/05/2019	7.659	1.64	0.690	141.95	5.98	7.974	2.578	24:00:00				
13/05/2019	8.588	1.52	0.713	136.12	8.55	8.428	3.562	24:00:00				
14/05/2019	8.109	1.54	0.702	119.29	8.05	4.817	4.828	24:00:00				
15/05/2019	7.716	1.70	0.678	121.06	7.18	6.410	3.497	24:00:00				
16/05/2019	7.888	2.02	0.740	131.45	6.75	6.108	3.544	24:00:00				
17/05/2019	8.166	1.98	0.794	116.90	8.04	4.513	3.368	24:00:00				
18/05/2019	7.759	2.29	0.820	116.54	6.09	5.555	3.370	24:00:00				
19/05/2019	7.716	2.96	0.747	113.68	5.72	10.865	3.576	24:00:00				
20/05/2019	7.571	3.23	0.827	112.68	6.19	13.328	3.245	24:00:00				
21/05/2019	7.802	3.30	0.911	114.30	9.87	8.059	4.804	24:00:00				
22/05/2019	8.321	3.27	0.904	112.51	11.53	9.465	5.006	24:00:00				
23/05/2019	7.878	3.14	0.882	101.74	5.27	6.664	3.280	24:00:00				
24/05/2019	6.785	2.84	0.801	92.05	5.93	3.764	2.795	23:06:50				
25/05/2019	12.763	3.22	0.932	89.55	2.94	4.713	1.473	24:00:00				
26/05/2019	8.515	3.77	0.909	89.86	3.63	4.754	1.413	24:00:00				
27/05/2019	6.747	5.15	0.567	103.38	4.77	3.416	1.197	24:00:00				
28/05/2019	7.525	4.35	0.997	106.30	3.40	7.633	0.664	24:00:00				
29/05/2019	7.660	3.94	1.308	102.61	4.61	7.489	0.747	24:00:00				
30/05/2019	9.078	3.71	1.314	105.47	6.71	4.704	0.875	24:00:00				
31/05/2019	8.505	3.61	1.242	110.88	12.57	5.017	2.768	24:00:00				
Min	6.703	0.55	0.567	89.55	2.94	1.903	0.664					
Max	12.763	5.15	2.877	146.76	14.59	13.328	5.006					
Cumul	249.135	76.25	28.389	3609.19	255.95	183.776	91.160	30j 18:57:10				
VLE Flux Jour	0	0	0	0	0	0	0					



Rapport DREAL Flux Mensuel Ligne 1

Rapport Flux Mensuel Flux Ligne 1 Juin 2019

Unité Kg	CO	COT	HCL	NOx	POUSSIÈRE	SO2	NH3	MarcheFourL1
VLE Jour	Kg	Kg	Kg	Kg	Kg	Kg	Kg	hh:mm:ss
	19.2	19.2	153.6	19.2	19.2	19.2	96	19.2
01/06/2019	5.736	2.46	72.75	0.642	5.93	5.93	3.335	14:24:20
02/06/2019	Arrêt	Arrêt	Arrêt	Arrêt	Arrêt	Arrêt	Arrêt	00:00:00
03/06/2019	Arrêt	Arrêt	Arrêt	Arrêt	Arrêt	Arrêt	Arrêt	00:00:00
04/06/2019	Indisponible	Indisponible	Indisponible	Indisponible	Indisponible	Indisponible	Indisponible	00:00:00
05/06/2019	Arrêt	Arrêt	Arrêt	Arrêt	Arrêt	Arrêt	Arrêt	00:00:00
06/06/2019	Arrêt	Arrêt	Arrêt	Arrêt	Arrêt	Arrêt	Arrêt	00:00:00
07/06/2019	Arrêt	Arrêt	Arrêt	Arrêt	Arrêt	Arrêt	Arrêt	00:00:00
08/06/2019	Arrêt	Arrêt	Arrêt	Arrêt	Arrêt	Arrêt	Arrêt	00:00:00
09/06/2019	Arrêt	Arrêt	Arrêt	Arrêt	Arrêt	Arrêt	Arrêt	00:00:00
10/06/2019	Arrêt	Arrêt	Arrêt	Arrêt	Arrêt	Arrêt	Arrêt	00:00:00
11/06/2019	Arrêt	Arrêt	Arrêt	Arrêt	Arrêt	Arrêt	Arrêt	00:00:00
12/06/2019	Arrêt	Arrêt	Arrêt	Arrêt	Arrêt	Arrêt	Arrêt	00:00:00
13/06/2019	Arrêt	Arrêt	Arrêt	Arrêt	Arrêt	Arrêt	Arrêt	00:00:00
14/06/2019	Arrêt	Arrêt	Arrêt	Arrêt	Arrêt	Arrêt	Arrêt	00:00:00
15/06/2019	Arrêt	Arrêt	Arrêt	Arrêt	Arrêt	Arrêt	Arrêt	00:00:00
16/06/2019	Arrêt	Arrêt	Arrêt	Arrêt	Arrêt	Arrêt	Arrêt	00:00:00
17/06/2019	Arrêt	Arrêt	Arrêt	Arrêt	Arrêt	Arrêt	Arrêt	00:00:00
18/06/2019	Arrêt	Arrêt	Arrêt	Arrêt	Arrêt	Arrêt	Arrêt	00:00:00
19/06/2019	Arrêt	Arrêt	Arrêt	Arrêt	Arrêt	Arrêt	Arrêt	00:00:00
20/06/2019	Arrêt	Arrêt	Arrêt	Arrêt	Arrêt	Arrêt	Arrêt	00:00:00
21/06/2019	Arrêt	Arrêt	Arrêt	Arrêt	Arrêt	Arrêt	Arrêt	00:00:00
22/06/2019	Arrêt	Arrêt	Arrêt	Arrêt	Arrêt	Arrêt	Arrêt	00:00:00
23/06/2019	Arrêt	Arrêt	Arrêt	Arrêt	Arrêt	Arrêt	Arrêt	00:00:00
24/06/2019	Arrêt	Arrêt	Arrêt	Arrêt	Arrêt	Arrêt	Arrêt	00:00:00
25/06/2019	Arrêt	Arrêt	Arrêt	Arrêt	Arrêt	Arrêt	Arrêt	00:00:00
26/06/2019	Arrêt	Arrêt	Arrêt	Arrêt	Arrêt	Arrêt	Arrêt	00:00:00
27/06/2019	Arrêt	Arrêt	Arrêt	Arrêt	Arrêt	Arrêt	Arrêt	00:00:00
28/06/2019	Arrêt	Arrêt	Arrêt	Arrêt	Arrêt	Arrêt	Arrêt	00:00:00
29/06/2019	Arrêt	Arrêt	Arrêt	Arrêt	Arrêt	Arrêt	Arrêt	00:00:00
30/06/2019	Arrêt	Arrêt	Arrêt	Arrêt	Arrêt	Arrêt	Arrêt	00:00:00
Min	5.736	2.46	72.75	0.642	5.93	5.93	3.335	2.266
Max	5.736	2.46	72.75	0.642	5.93	5.93	3.335	2.266
Cumul	5.736	2.46	72.75	0.642	5.93	5.93	3.335	14:24:20
VLE Flux Jour	0	0	0	0	0	0	0	0

* Le 04/06/2019, coupure électrique général EDF (maintenance préventive lors de l'arrêt technique EME)



Rapport DREAL Flux Mensuel Ligne 1

Rapport Flux Mensuel											Juillet 2019	
Flux Ligne 1												
CO	COT	HCL	NOx	POUSSIERE	SO2	NH3	MarcheFourLI					
Unité Kg	Kg	Kg	Kg	Kg	Kg	Kg	hh:mm:ss	hh:mm:ss				
VLE Jour	57.61	19.2	19.2	153.6	19.2	96	19.2					
01/07/2019	Arrêt	Arrêt	Arrêt	Arrêt	Arrêt	Arrêt	Arrêt	Arrêt	00:00:00	00:00:00		
02/07/2019	Arrêt	Arrêt	Arrêt	Arrêt	Arrêt	Arrêt	Arrêt	Arrêt	00:00:00	00:00:00		
03/07/2019	Arrêt	Arrêt	Arrêt	Arrêt	Arrêt	Arrêt	Arrêt	Arrêt	00:00:00	00:00:00		
04/07/2019	Arrêt	Arrêt	Arrêt	Arrêt	Arrêt	Arrêt	Arrêt	Arrêt	00:00:00	00:00:00		
05/07/2019	Arrêt	Arrêt	Arrêt	Arrêt	Arrêt	Arrêt	Arrêt	Arrêt	00:00:00	00:00:00		
06/07/2019	Arrêt	Arrêt	Arrêt	Arrêt	Arrêt	Arrêt	Arrêt	Arrêt	00:00:00	00:00:00		
07/07/2019	Arrêt	Arrêt	Arrêt	Arrêt	Arrêt	Arrêt	Arrêt	Arrêt	00:00:00	00:00:00		
08/07/2019	Arrêt	Arrêt	Arrêt	Arrêt	Arrêt	Arrêt	Arrêt	Arrêt	00:00:00	00:00:00		
09/07/2019	Arrêt	Arrêt	Arrêt	Arrêt	Arrêt	Arrêt	Arrêt	Arrêt	00:00:00	00:00:00		
10/07/2019	Arrêt	Arrêt	Arrêt	Arrêt	Arrêt	Arrêt	Arrêt	Arrêt	00:00:00	00:00:00		
11/07/2019	Arrêt	Arrêt	Arrêt	Arrêt	Arrêt	Arrêt	Arrêt	Arrêt	00:00:00	00:00:00		
12/07/2019	Arrêt	Arrêt	Arrêt	Arrêt	Arrêt	Arrêt	Arrêt	Arrêt	00:00:00	00:00:00		
13/07/2019	Arrêt	Arrêt	Arrêt	Arrêt	Arrêt	Arrêt	Arrêt	Arrêt	00:00:00	00:00:00		
14/07/2019	Arrêt	Arrêt	Arrêt	Arrêt	Arrêt	Arrêt	Arrêt	Arrêt	00:00:00	00:00:00		
15/07/2019	Arrêt	Arrêt	Arrêt	Arrêt	Arrêt	Arrêt	Arrêt	Arrêt	00:00:00	00:00:00		
16/07/2019	8.591	1.52	0.218	23.23	1.43	0.006	0.004	0.004	05:22:30	05:22:30		
17/07/2019	33.117	5.65	1.027	96.30	11.50	0.000	0.169	0.169	24:00:00	24:00:00		
18/07/2019	29.453	5.29	0.934	100.30	6.14	0.000	0.023	0.023	23:20:20	23:20:20		
19/07/2019	33.182	5.72	1.146	104.69	5.95	0.000	0.134	0.134	23:47:50	23:47:50		
20/07/2019	32.824	6.01	1.886	108.85	5.72	11.078	0.118	0.118	24:00:00	24:00:00		
21/07/2019	33.898	6.09	2.351	108.10	5.72	28.610	0.199	0.199	24:00:00	24:00:00		
22/07/2019	32.112	5.48	2.313	111.18	6.03	7.748	0.133	0.133	24:00:00	24:00:00		
23/07/2019	29.916	4.93	2.451	107.50	6.08	0.000	0.177	0.177	24:00:00	24:00:00		
24/07/2019	27.846	4.32	2.930	113.82	5.64	0.008	0.203	0.203	24:00:00	24:00:00		
25/07/2019	19.524	3.15	2.034	77.30	3.79	0.015	0.134	0.134	24:00:00	24:00:00		
26/07/2019	18.945	8.76	1.821	72.92	4.05	26.683	0.107	0.107	24:00:00	24:00:00		
27/07/2019	33.500	16.28	2.234	125.42	6.49	42.349	0.259	0.259	24:00:00	24:00:00		
28/07/2019	32.005	14.20	2.423	123.84	5.48	26.247	0.151	0.151	24:00:00	24:00:00		
29/07/2019	26.465	11.61	2.077	108.02	3.45	11.362	0.240	0.240	24:00:00	24:00:00		
30/07/2019	31.455	14.09	2.680	119.33	5.01	12.264	0.270	0.270	24:00:00	24:00:00		
31/07/2019	29.681	13.64	2.266	110.17	4.37	7.085	0.116	0.116	24:00:00	24:00:00		
Min	8.591	1.52	0.218	23.23	1.43	0.000	0.004	0.004				
Max	33.898	16.28	2.930	125.42	11.50	42.349	0.270	0.270				
Cumul	452.514	126.74	30.791	1610.97	86.85	173.455	2.437	2.437	15j 04:30:40			
VLE Flux Jour	0	0	0	0	0	0	0	0				



Rapport DREAL Flux Mensuel Ligne 1

Rapport Flux Mensuel												Aout 2019	
Flux Ligne 1													
CO	COT	HCL	NOx	POUSSIERE	SO2	NH3	MarcheFourL1						
Unité K-g	K-g	K-g	K-g	K-g	K-g	K-g	hh:mm:ss						
VLE Jour	57.61	19.2	19.2	153.6	19.2	96	19.2						
01/08/2019	27.406	8.01	1.428	124.01	8.86	0.537	7.272						
02/08/2019	25.763	3.08	1.036	119.70	6.88	0.016	0.379						
03/08/2019	23.636	3.37	1.423	119.86	6.71	3.705	0.305						
04/08/2019	13.679	3.03	0.851	63.62	3.13	4.749	0.112						
05/08/2019	Arrêt	Arrêt	Arrêt	Arrêt	Arrêt	Arrêt	Arrêt						
06/08/2019	Arrêt	Arrêt	Arrêt	Arrêt	Arrêt	Arrêt	Arrêt						
07/08/2019	3.029	0.84	0.187	14.24	1.47	0.000	0.023						
08/08/2019	22.533	5.09	1.732	104.11	9.97	0.000	0.283						
09/08/2019	23.275	4.94	2.320	111.34	12.20	2.950	0.341						
10/08/2019	21.287	3.98	2.584	100.72	13.66	0.429	0.139						
11/08/2019	24.321	4.57	2.738	112.11	15.45	1.930	0.087						
12/08/2019	24.055	4.37	3.127	107.40	14.23	1.270	0.030						
13/08/2019	20.648	3.94	2.311	109.68	16.20	4.941	0.167						
14/08/2019	24.473	4.12	3.290	117.02	15.76	12.135	0.344						
15/08/2019	22.280	4.08	3.135	118.88	15.68	10.388	0.495						
16/08/2019	21.655	3.90	3.038	117.56	15.96	0.325	0.081						
17/08/2019	21.968	4.78	2.656	117.30	17.58	0.265	0.222						
18/08/2019	20.434	4.49	2.669	120.33	13.15	2.303	0.131						
19/08/2019	19.546	3.79	2.376	114.66	15.38	0.000	0.036						
20/08/2019	19.022	3.74	2.416	115.46	15.11	0.000	0.097						
21/08/2019	19.791	3.76	2.325	117.51	15.16	0.000	0.052						
22/08/2019	20.801	3.64	2.291	118.30	15.20	1.353	0.299						
23/08/2019	19.092	3.74	2.774	117.59	15.42	3.415	0.039						
24/08/2019	19.942	3.86	3.106	122.28	15.78	6.721	0.462						
25/08/2019	19.767	3.90	3.433	121.87	17.49	3.821	0.049						
26/08/2019	18.412	3.67	3.111	119.80	14.56	2.906	0.219						
27/08/2019	19.038	4.01	2.857	119.30	15.84	2.054	0.076						
28/08/2019	16.686	3.79	2.066	110.23	11.48	1.003	0.075						
29/08/2019	20.901	4.61	1.830	122.63	16.45	1.987	0.112						
30/08/2019	17.654	3.93	1.936	112.39	15.48	1.927	0.040						
31/08/2019	19.085	4.45	2.288	124.96	16.13	2.235	0.045						
Min	3.029	0.84	0.187	14.24	1.47	0.000	0.023						
Max	27.406	8.01	3.433	124.96	17.58	12.135	7.272						
Cumul	590.179	117.48	67.334	3214.86	386.37	73.365	12.012						
VLE Flux Jour	0	0	0	0	0	0	0	27j 15:17:00					



Rapport DREAL Flux Mensuel Ligne 1

Rapport Flux Mensuel												Septembre 2019	
Flux Ligne 1													
CO	COT	HCL	NOx	POUSSIERE	SO2	NH3	MarcheFourL1						
Unité Kg	Kg	Kg	Kg	Kg	Kg	Kg	hh:mm:ss	hh:mm:ss					
VLE Jour	57.61	19.2	19.2	153.6	19.2	96	19.2	19.2					
01/09/2019	19.354	4.53	2.021	125.44	16.11	2.590	0.206	24:00:00					
02/09/2019	18.882	2.144	2.144	124.53	15.88	3.892	0.587	24:00:00					
03/09/2019	19.603	4.57	2.133	119.96	15.48	4.198	0.440	24:00:00					
04/09/2019	18.318	4.22	2.135	110.85	15.74	3.133	0.062	22:34:40					
05/09/2019	19.279	4.39	2.041	117.82	16.18	3.749	0.131	23:58:40					
06/09/2019	25.972	4.61	2.064	116.68	17.50	4.610	0.010	24:00:00					
07/09/2019	19.886	4.39	2.131	117.12	12.32	3.970	0.287	24:00:00					
08/09/2019	21.211	4.81	2.039	120.12	13.56	4.217	0.031	24:00:00					
09/09/2019	21.291	4.74	2.178	116.99	15.58	4.705	0.039	24:00:00					
10/09/2019	21.635	4.69	2.369	125.75	17.27	5.307	0.111	24:00:00					
11/09/2019	20.897	4.49	3.504	124.13	17.52	5.512	0.218	24:00:00					
12/09/2019	21.911	5.09	2.469	120.11	12.27	3.884	0.033	24:00:00					
13/09/2019	22.187	5.35	2.294	122.35	14.18	4.045	0.010	24:00:00					
14/09/2019	22.138	4.50	4.318	120.21	12.78	4.169	0.419	24:00:00					
15/09/2019	20.918	4.39	2.295	127.93	15.76	3.709	0.122	24:00:00					
16/09/2019	22.383	4.43	1.782	119.96	14.46	2.903	0.184	23:43:20					
17/09/2019	21.270	4.58	1.450	116.83	13.11	3.018	0.238	24:00:00					
18/09/2019	20.306	4.50	1.457	114.95	14.97	4.277	0.026	24:00:00					
19/09/2019	24.133	5.70	1.720	108.22	16.06	4.787	0.100	24:00:00					
20/09/2019	24.024	5.60	1.889	109.60	17.15	5.534	0.041	24:00:00					
21/09/2019	23.154	5.83	2.191	111.28	17.44	5.387	0.057	24:00:00					
22/09/2019	22.893	6.93	1.979	110.94	13.53	4.033	0.270	24:00:00					
23/09/2019	27.106	6.94	1.797	108.55	12.72	4.862	0.219	23:58:10					
24/09/2019	22.932	6.88	1.788	113.67	14.91	6.051	0.243	24:00:00					
25/09/2019	23.506	6.43	4.545	123.08	15.80	10.898	0.301	24:00:00					
26/09/2019	23.618	6.47	6.088	121.72	16.49	8.459	0.190	23:41:10					
27/09/2019	23.269	6.31	4.061	120.11	15.20	7.943	0.129	24:00:00					
28/09/2019	23.569	6.31	3.805	124.39	13.51	9.574	0.106	24:00:00					
29/09/2019	23.240	6.67	3.639	124.99	11.90	10.277	0.081	24:00:00					
30/09/2019	22.468	6.26	3.544	121.42	13.07	14.630	0.203	24:00:00					
Min	18.318	4.22	1.450	108.22	11.90	2.590	0.010						
Max	27.106	6.94	6.088	127.93	17.52	14.630	0.587						
Cumul	661.353	158.86	77.870	3559.70	448.45	174.323	5.094		29j 21:56:00				
VLE Flux Jour	0	0	0	0	0	0	0						

Rapport DREAL Flux Mensuel Ligne 1

Rapport Flux Mensuel											Octobre 2019	
Flux Ligne 1												
Unité Kg	CO	COT	HCL	NOx	POUSSIERE	SO2	NH3	Marche	Four	L1		
VLE Jour	Kg	Kg	Kg	Kg	Kg	Kg	Kg	hh	mm	ss		
	57,61	19,2	19,2	153,6	19,2	96	19,2					
01/10/2019	23.189	6.74	3.748	124.93	14.73	10.827	0.269				24:00:00	
02/10/2019	23.853	5.97	2.528	127.06	12.89	10.420	0.461				24:00:00	
03/10/2019	23.353	6.08	2.252	127.00	14.08	10.979	0.009				24:00:00	
04/10/2019	22.229	6.47	3.338	129.55	12.77	12.367	0.196				24:00:00	
05/10/2019	22.728	6.43	3.149	125.52	12.73	10.718	0.273				24:00:00	
06/10/2019	19.019	5.40	2.601	151.25	10.59	11.527	0.294				23:00:10	
07/10/2019	19.729	5.91	1.994	107.87	11.26	9.609	0.206				21:22:50	
08/10/2019	24.277	7.98	2.217	124.15	12.90	16.060	0.206				24:00:00	
09/10/2019	23.621	7.74	1.786	127.75	14.41	15.438	1.179				24:00:00	
10/10/2019	22.514	6.81	1.463	123.09	11.42	17.829	1.441				24:00:00	
11/10/2019	22.564	6.83	1.136	125.53	11.76	9.515	1.053				24:00:00	
12/10/2019	20.609	7.00	0.640	125.89	11.17	7.918	1.255				24:00:00	
13/10/2019	19.630	6.51	0.431	126.03	11.80	14.241	1.605				24:00:00	
14/10/2019	19.031	6.28	1.059	124.54	9.10	18.796	0.449				24:00:00	
15/10/2019	19.865	6.76	1.650	125.14	10.41	19.404	0.242				24:00:00	
16/10/2019	19.952	7.05	1.935	104.55	15.45	14.234	0.325				24:00:00	
17/10/2019	20.155	7.51	2.068	94.23	11.88	17.669	0.116				24:00:00	
18/10/2019	20.830	6.42	2.065	118.47	14.29	14.644	0.689				24:00:00	
19/10/2019	20.927	6.79	1.903	120.42	12.33	9.529	0.376				24:00:00	
20/10/2019	20.210	6.40	1.705	120.53	12.37	23.006	0.547				24:00:00	
21/10/2019	20.999	7.08	2.643	102.20	14.08	11.162	0.510				23:56:30	
22/10/2019	22.261	7.88	1.983	111.36	16.25	7.515	0.365				23:56:30	
23/10/2019	21.149	7.15	1.835	105.70	7.30	4.474	0.474				24:00:00	
24/10/2019	19.358	6.33	1.543	97.61	5.19	6.563	0.238				24:00:00	
25/10/2019	5.110	0.72	0.505	25.68	0.64	0.128	0.246				23:13:40	
26/10/2019	Arrêt	Arrêt	Arrêt	Arrêt	Arrêt	Arrêt	0.030				11:31:50	
27/10/2019	Arrêt	Arrêt	Arrêt	Arrêt	Arrêt	Arrêt	Arrêt				00:00:00	
28/10/2019	Arrêt	Arrêt	Arrêt	Arrêt	Arrêt	Arrêt	Arrêt				00:00:00	
29/10/2019	10.943	2.54	0.604	50.47	5.84	2.739	0.039				00:00:00	
30/10/2019	21.238	4.90	1.418	108.63	8.92	6.989	0.260				11:34:30	
31/10/2019	18.695	4.18	1.425	100.01	8.27	5.814	0.069				24:00:00	
31/10/2019	18.695	4.18	1.425	100.01	8.27	5.814	0.069				22:35:00	
Min	5.110	0.72	0.431	25.68	0.64	0.128	0.009					
Max	24.277	7.98	3.748	151.25	16.25	23.006	1.605					
Annuel	568.038	173.86	51.624	3155.16	314.83	320.133	13.216					
VLE Flux Jour	0	0	0	0	0	0	0					
											26j 17:11:00	

Rapport DREAL Flux Mensuel Ligne 1

Rapport Flux Mensuel											Novembre 2019	
Flux Ligne 1												
CO	COT	HCL	NOx	POUSSIERE	SO2	NH3	MarcheFourL1					
Unité Kg	Kg	Kg	Kg	Kg	Kg	Kg	hh:mm:ss					
VLE Jour	57.61	19.2	19.2	153.6	19.2	96	19.2					
01/11/2019	20.517	4.96	1.965	112.69	7.66	6.460	0.057	24:00:00				
02/11/2019	20.518	4.47	2.030	110.76	7.22	6.633	0.164	24:00:00				
03/11/2019	20.435	4.47	1.982	109.88	7.38	6.955	0.244	24:00:00				
04/11/2019	20.650	4.34	2.139	99.61	4.75	5.356	0.204	24:00:00				
05/11/2019	19.657	4.43	1.843	111.01	4.97	7.429	0.069	24:00:00				
06/11/2019	16.861	3.85	2.001	103.96	5.43	8.133	0.115	24:00:00				
07/11/2019	18.313	4.33	1.856	109.21	5.30	6.261	0.200	24:00:00				
08/11/2019	18.807	4.39	1.677	114.34	5.06	6.534	0.041	24:00:00				
09/11/2019	19.874	4.75	1.643	120.16	6.04	7.103	0.056	24:00:00				
10/11/2019	18.885	4.75	1.586	120.08	4.58	6.742	0.115	24:00:00				
11/11/2019	18.185	4.79	1.576	119.34	4.07	7.046	0.039	24:00:00				
12/11/2019	18.273	4.79	1.590	119.09	4.25	6.700	0.199	24:00:00				
13/11/2019	18.325	4.83	1.593	119.69	4.90	7.261	0.071	24:00:00				
14/11/2019	18.429	4.76	1.677	116.64	4.08	6.444	0.168	24:00:00				
15/11/2019	18.633	4.76	1.581	114.22	3.68	6.570	0.119	24:00:00				
16/11/2019	19.401	4.86	1.517	113.79	4.16	7.712	0.060	24:00:00				
17/11/2019	17.754	4.50	1.834	115.08	3.85	8.056	0.221	24:00:00				
18/11/2019	18.257	4.48	1.996	104.98	3.09	6.630	0.161	24:00:00				
19/11/2019	18.923	4.64	1.757	107.43	3.17	7.066	0.095	24:00:00				
20/11/2019	17.347	4.25	1.300	93.54	2.81	6.447	0.067	22:21:30				
21/11/2019	19.745	4.76	1.527	108.97	4.60	8.087	0.148	24:00:00				
22/11/2019	18.640	4.27	1.950	107.49	4.60	7.533	0.100	24:00:00				
23/11/2019	18.612	4.06	1.909	103.98	3.57	6.389	0.119	24:00:00				
24/11/2019	18.067	4.21	1.780	103.89	3.00	6.973	0.183	24:00:00				
25/11/2019	19.394	4.06	1.713	101.89	3.32	6.615	0.055	24:00:00				
26/11/2019	17.706	3.73	1.788	106.81	3.68	6.587	0.048	24:00:00				
27/11/2019	17.756	3.33	1.700	102.73	3.19	6.562	0.020	24:00:00				
28/11/2019	18.409	3.77	1.831	108.06	4.91	8.194	0.144	24:00:00				
29/11/2019	22.740	3.65	2.482	105.36	4.01	17.622	0.116	23:55:20				
30/11/2019	16.922	3.21	2.117	99.10	2.50	15.278	0.091	24:00:00				
Min	16.861	3.21	1.300	93.54	2.50	5.356	0.020	24:00:00				
Max	22.740	4.96	2.482	120.16	7.66	17.622	0.244	24:00:00				
Cumul	566.035	130.45	53.940	3283.78	133.83	227.378	3.489	29j 22:16:50				
VLE Flux Jour	0	0	0	0	0	0	0	0				

Rapport DREAL Flux Mensuel Ligne 1

Rapport Flux Mensuel											Decembre 2019	
Flux Ligne 1												
CO	COT	HCL	NOx	POUSSIERE	SO2	NH3	MarcheFourL1					
Unité Kg	Kg	Kg	Kg	Kg	Kg	Kg	hh:mm:ss					
VLE Jour	57.61	19.2	19.2	153.6	19.2	96	19.2					
01/12/2019	14.664	2.61	1.897	98.44	2.26	12.425	0.132					
02/12/2019	17.370	3.31	1.836	102.95	3.59	11.902	0.042					
03/12/2019	17.249	3.75	2.202	110.98	4.71	7.923	0.129					
04/12/2019	17.327	4.06	1.704	112.67	3.62	15.061	0.104					
05/12/2019	17.587	3.93	1.519	109.54	3.49	15.423	0.069					
06/12/2019	17.297	3.74	1.805	108.49	3.23	22.481	0.116					
07/12/2019	16.486	3.40	2.286	107.65	2.95	11.364	0.030					
08/12/2019	18.322	3.64	2.040	117.03	11.03	16.873	0.063					
09/12/2019	18.084	3.58	2.140	122.72	11.41	15.164	0.112					
10/12/2019	18.261	3.86	4.906	116.04	6.65	9.428	0.133					
11/12/2019	17.950	3.77	2.328	116.98	7.20	12.063	0.218					
12/12/2019	17.353	3.72	2.004	113.35	5.85	10.181	0.120					
13/12/2019	17.680	3.58	2.213	113.72	6.44	10.328	0.071					
14/12/2019	17.418	3.52	2.122	120.90	4.86	7.764	0.111					
15/12/2019	16.889	3.40	1.870	123.05	3.59	11.191	0.042					
16/12/2019	17.604	3.58	1.950	123.44	4.13	15.745	0.094					
17/12/2019	16.373	3.21	2.349	121.85	3.34	23.014	0.060					
18/12/2019	17.166	3.39	1.889	120.84	3.34	19.335	0.109					
19/12/2019	16.839	3.30	2.377	127.02	4.29	15.549	0.129					
20/12/2019	16.317	3.33	1.956	120.37	3.60	8.758	0.099					
21/12/2019	17.248	3.48	1.612	119.43	3.18	7.933	0.078					
22/12/2019	15.642	3.45	1.618	116.62	2.83	10.614	0.366					
23/12/2019	21.339	3.94	1.660	118.21	3.92	11.565	0.082					
24/12/2019	16.406	3.91	1.763	123.22	3.34	12.343	0.058					
25/12/2019	16.687	3.85	1.714	123.33	3.26	17.395	0.057					
26/12/2019	16.825	4.04	1.574	122.15	3.07	18.038	0.071					
27/12/2019	16.900	3.74	1.630	120.88	3.06	15.686	0.269					
28/12/2019	16.731	3.85	1.531	117.02	2.41	9.757	0.186					
29/12/2019	16.607	4.11	1.556	118.79	2.30	14.869	0.051					
30/12/2019	16.845	4.29	1.587	117.03	2.27	20.976	0.069					
31/12/2019	17.013	4.04	1.572	118.85	2.49	25.824	0.039					
Min	14.664	2.61	1.519	98.44	2.26	7.764	0.030					
Max	21.339	4.29	4.906	127.02	11.41	25.824	0.366					
Cumul	532.479	113.38	61.210	3623.56	131.71	436.972	3.309	30j 23:34:40				
VLE Flux Jour	0	0	0	0	0	0	0					

Rapport DREAL Mensuel Ligne 1

Mensuel IC95 Mensuel L1																Janvier 2019	
Date	CO mg/Nm3	COT mg/Nm3	HCL mg/Nm3	NOx mg/Nm3	POUSSIÈRE mg/Nm3	SO2 mg/Nm3	NH3 mg/Nm3	Vitesse m/s	O2 %	TSS L1 degrec	MarchePoul.L1 h1:mn:ss	Tonnage OML1		Tonnage DASRL1			
												Tonnage	Tonnage	Tonnage	Tonnage		
01/01/2019	3.71	100	20	60	140	30	200	10	15	850	850	2400000	307.6	23	0.75		
02/01/2019	3.67	50	10	10	80	10	50	10				2400000	306.3	0.1	0.03		
03/01/2019	3.67	50	10	10	80	10	50	10				2400000	312.6	0.1	0.16		
04/01/2019	3.63	50	10	10	80	10	50	10				2400000	297.9	0.6	0.20		
05/01/2019	3.76	50	10	10	80	10	50	10				2400000	310.1	0.3	0.10		
06/01/2019	3.22	50	10	10	80	10	50	10				2400000	299.9	2.6	0.87		
07/01/2019	3.52	50	10	10	80	10	50	10				2400000	244.4	7.7	3.15		
08/01/2019	3.56	50	10	10	80	10	50	10				2400000	285.6	5.3	2.00		
09/01/2019	3.52	50	10	10	80	10	50	10				2400000	265.6	8.9	3.54		
10/01/2019	3.52	50	10	10	80	10	50	10				2400000	251.6	8.9	3.54		
11/01/2019	3.62	50	10	10	80	10	50	10				2400000	280.9	1.7	0.61		
12/01/2019	3.72	50	10	10	80	10	50	10				2400000	306.3	0.0	0.00		
13/01/2019	3.37	50	10	10	80	10	50	10				2400000	306.4	0.2	0.07		
14/01/2019	3.38	50	10	10	80	10	50	10				2400000	276.8	9.3	3.36		
15/01/2019	3.58	50	10	10	80	10	50	10				2400000	276.7	6.7	2.42		
16/01/2019	3.60	50	10	10	80	10	50	10				2400000	262.9	6.9	2.62		
17/01/2019	3.53	50	10	10	80	10	50	10				2400000	265.7	18.0	6.83		
18/01/2019	3.54	50	10	10	80	10	50	10				2400000	277.4	22.7	8.18		
19/01/2019	3.41	50	10	10	80	10	50	10				2400000	299.9	11.5	3.91		
20/01/2019	3.44	50	10	10	80	10	50	10				2400000	247.7	19.2	7.75		
21/01/2019	3.49	50	10	10	80	10	50	10				2400000	219.2	28.4	12.04		
22/01/2019	3.39	50	10	10	80	10	50	10				2400000	264.4	21.2	8.02		
23/01/2019	3.20	50	10	10	80	10	50	10				2400000	257.2	38.9	11.24		
24/01/2019	3.25	50	10	10	80	10	50	10				2400000	277.1	27.4	9.89		
25/01/2019	3.59	50	10	10	80	10	50	10				2400000	304.9	10.3	3.38		
26/01/2019	3.29	50	10	10	80	10	50	10				2400000	306.3	15.8	5.16		
27/01/2019	3.30	50	10	10	80	10	50	10				2400000	273.4	20.7	7.57		
28/01/2019	3.53	50	10	10	80	10	50	10				2400000	276.6	21.2	7.66		
29/01/2019	3.56	50	10	10	80	10	50	10				2400000	297.3	4.6	1.55		
30/01/2019	3.42	50	10	10	80	10	50	10				2400000	303.5	1.5	0.49		
31/01/2019																	
Max	3.76		0.73	0.79	65.59	7.90	11.58	1.56	19.74	10.66	1114.9		312.6	21.2	12.84		
Min	3.20		0.11	0.50	65.15	3.15	1.93	0.27	19.28	9.88	1064.5		219.2	0.0	0.00		
Nb Jour Jans	0		0	0	0	0	0	0	0	0	0		0	0	0		
Nb Jour Max	0		0	0	0	0	0	0	0	0	0		0	0	0		
Dep-VLE Max	00:00		00:00	00:00	00:00	00:00	00:00	00:00	00:00	00:00	00:00		00:00	00:00	00:00		
Dep-Small Min																	
Dep-VLE 1/2h																	
Moy. Mensuelle	3.49		0.39	0.62	65.53	4.99	5.59	0.67	19.74	10.29	1068.0	311 00:00:00	87186.6	316.5	0.00		
% dejours HG	0.00		0.00	0.00	0.00	0.00	0.00	0.00	0.00	0.00	0.0	0.0	0.0	0.0	0.0		
% dejours HG Annuel	0.00		0.00	0.00	0.00	0.00	0.00	0.00	0.00	0.00	0.0	0.0	0.0	0.0	0.0		

Rapport DREAL Mensuel Ligne 1

Rapport Mensuel															Mars 2019	
Mesure: IC 95 Mensuel L1																
Unité	CO	COT	HCL	NOx	POUSSIÈRE	SO2	NH3	Vitesse	O2	TZS L1	MarchéFonL1	Tomasse OML1	Tomasse DASRL1	Ratio Jour L1		
VLE Max	mg/Nm3	mg/Nm3	mg/Nm3	mg/Nm3	mg/Nm3	mg/Nm3	mg/Nm3	m/s	%	degréC	bl/min.ms	Tonne	Tonne			
Seuil Min	50	100	10	10	80	10	50	10	15							
VLE 1/2h	100	100	20	60	160	30	200	20			850					
01/03/2019	3.62	0.14	0.70	5.26	65.26	3.63	2.28	0.79	19.89	10.21	1073.1	24000.00	284.1	3.7		
02/03/2019	3.76	0.22	0.60	3.76	65.66	4.66	1.44	0.39	4.66	9.85	1073.1	24000.00	318.5	1.4		
03/03/2019	3.28	0.41	0.67	3.90	65.22	3.90	1.62	0.74	19.75	9.88	1084.9	24000.00	298.6	0.07		
04/03/2019	3.31	0.22	0.66	3.94	66.03	4.12	1.94	0.47	19.04	10.11	1071.3	24000.00	302.4	4.3		
05/03/2019	3.37	0.21	0.73	3.73	66.03	4.12	1.94	0.47	19.04	10.11	1071.3	24000.00	351.3	2.33		
06/03/2019	3.54	0.29	0.72	3.54	65.75	4.72	3.96	0.60	4.72	9.80	1074.6	24000.00	365.9	4.3		
07/03/2019	3.58	0.21	0.67	3.58	65.43	4.85	4.85	0.34	4.85	9.78	1074.6	24000.00	344.2	1.18		
08/03/2019	3.57	0.11	0.66	3.57	65.72	4.24	2.60	0.37	4.24	9.84	1074.6	24000.00	312.8	2.33		
09/03/2019	3.82	0.14	0.59	3.82	65.42	5.38	1.45	0.86	19.39	9.62	1074.6	24000.00	347.4	3.5		
10/03/2019	3.15	0.14	0.58	3.15	65.23	4.11	3.32	0.81	19.62	9.67	1092.1	24000.00	352.2	1.6		
11/03/2019	3.22	0.00	0.67	3.22	65.30	3.53	3.88	0.41	19.21	9.81	1100.3	24000.00	297.2	0.45		
12/03/2019	3.00	0.00	0.87	3.00	65.64	6.51	3.97	0.27	6.51	9.98	1091.1	24000.00	258.1	4.91		
13/03/2019	3.33	0.91	3.33	3.33	66.12	5.12	11.06	0.58	18.15	10.01	1080.4	24000.00	280.7	8.96		
14/03/2019	3.48	0.14	0.68	3.48	65.56	4.91	10.43	0.79	19.79	9.94	1070.4	24000.00	302.8	5.42		
15/03/2019	3.71	0.33	0.68	3.71	65.52	4.64	4.64	1.23	17.33	10.09	1080.4	24000.00	276.8	9.8		
16/03/2019	4.49	0.42	1.44	4.49	55.82	7.19	11.28	1.72	18.97	10.03	1079.0	23134.50	295.2	0.83		
17/03/2019	3.41	0.25	0.50	3.41	65.42	4.24	14.49	1.69	19.28	9.99	1094.1	24000.00	317.5	0.45		
18/03/2019	3.66	0.20	0.55	3.66	66.02	6.57	13.69	1.47	19.25	10.25	1085.9	24000.00	272.0	0.00		
19/03/2019	4.20	0.02	0.55	4.20	65.49	6.09	13.77	1.53	19.20	10.47	1074.8	24000.00	341.0	2.83		
20/03/2019	5.99	0.17	0.51	5.99	65.32	3.93	9.15	1.50	18.72	10.15	1079.1	24000.00	285.5	7.0		
21/03/2019	3.76	0.48	0.51	3.76	65.16	8.81	9.64	2.13	18.94	10.53	1072.2	24000.00	265.6	3.12		
22/03/2019	3.45	0.18	0.44	3.45	66.39	5.67	7.73	1.64	18.03	10.22	1072.2	24000.00	300.8	1.75		
23/03/2019	5.21	1.47	2.51	5.21	68.98	8.56	3.29	1.66	16.99	10.28	1072.2	24000.00	211.7	0.17		
24/03/2019	3.67	2.65	2.65	3.67	66.13	6.92	4.78	1.46	18.91	10.28	1072.2	24000.00	341.1	0.00		
25/03/2019	3.97	2.10	0.23	3.97	66.13	3.18	7.79	0.17	18.25	10.10	1076.5	24000.00	311.4	0.00		
26/03/2019	3.97	2.61	0.29	3.97	66.13	3.18	7.79	0.17	18.25	10.10	1076.5	24000.00	295.9	1.4		
27/03/2019	4.48	2.89	0.59	4.48	55.75	7.20	3.81	0.77	18.69	10.33	1074.6	24000.00	311.4	2.38		
28/03/2019	4.43	2.81	0.43	4.43	65.74	5.51	2.26	0.36	10.79	10.20	1079.2	24000.00	308.8	8.0		
29/03/2019	4.29	2.89	1.04	4.29	65.45	4.49	2.86	0.50	18.82	10.16	1082.6	24000.00	279.8	2.01		
30/03/2019	4.65	3.00	1.19	4.65	65.96	5.40	3.06	0.34	19.13	10.10	1087.4	24000.00	300.8	5.8		
31/03/2019	4.21	2.88	1.16	4.21	65.66	4.74	2.13	0.28	19.13	9.90	1104.8	25000.00	309.1	2.2		
Max	5.99	3.00	2.51	5.99	65.66	4.74	2.13	0.28	19.13	9.90	1104.8	25000.00	309.1	0.1		
Moy. Mensuelle	3.91	0.88	0.83	3.91	65.27	5.46	5.45	1.01	19.00	10.06	1079.2	36116.22	930.44	163.0		
% distances HG	0.00	0.00	0.00	0.00	0.00	0.00	0.00	0.00	0.00	0.00	0.00	0.00	0.00	0.00		
% distances HG Annuel	0.00	0.00	0.00	0.00	0.00	0.00	0.00	0.00	0.00	0.00	0.00	0.00	0.00	0.00		

Contrôle réglementaire L1 - 30j HCL									
Dépassement >=H									
Dép. VLE jour	Nb Jour VLE	Nb Jour Max	Dép. VLE Max	Dép. Seuil Min	CO	NO2	NOx	CO2	Global
00:00	0	0	0	00:00	0	0	0	0	0
Dép. VLE	01:00	0	0	0	05:30	0	0	0	0
Nb Jour Incalculés	0	0	0	0	0	0	0	0	0
Inc. Cons >100h	0	0	0	0	0	0	0	0	0
Indisponibilité	00:30	0	0	0	00:30	0	0	00:30	0
									02:00
									01:30
									02:00

* Le 12/03/2019, dépassement de deux moyennes 30' en Pousssières à 42,07 mg/Nm3 et à 40,54 mg/Nm3 (pour une limite à 30) suite un débit trop important en air secondaire.
 * Le 15/03/2019, dépassement de cinq moyennes 30' en NOx à 187,71 mg/Nm3, à 262,40 mg/Nm3, à 232,49 mg/Nm3, à 176,67 mg/Nm3 et à 260,16 mg/Nm3 (pour une limite à 160) suite à deux mise en sécurité par bypass de la DENOX dû à la déconnexion accidentelle du tuyau d'air comprimé sur le registre en sortie DENOX.
 * Le 16/03/2019 => dépassement d'une moyenne 30' en NH3 à 40,65 mg/Nm3 (pour une limite à 20) suite à une mise en sécurité de la DENOX, le régulateur n'a pas été suffisamment réactif au moment de l'installation;
 => dépassement d'une moyenne 30' en Pousssières à 70,49 mg/Nm3 (pour une limite à 30) suite à un excès d'air dans le four et une vitesse élevée du ventilateur de tirage.
 * Le 21/03/2019, dépassement d'une moyenne 30' en CO à 113,31 mg/Nm3 (pour une limite à 30) suite à une remontée brutale du débit vapeur.
 * Le 22/03/2019, dépassement d'une moyenne 30' en Pousssières à 30,57 mg/Nm3 (pour une limite à 30) suite à une remontée brutale du débit vapeur.
 * Le 23/03/2019, dépassement de deux moyennes 30' en HCL à 78,71 mg/Nm3 et à 87,41 mg/Nm3 (pour une limite à 60) et d'une moyenne 30' en NOx à 178,84 mg/Nm3 (pour une limite à 160) suite au black OUT.
 * Le 24/03/2019, dépassement d'une moyenne 30' en Pousssières à 30,32 mg/Nm3 (pour une limite à 30) lors du soufflage des catalyseurs de la DENOX.
 * Le 30/03/2019, dépassement d'une moyenne 30' en Pousssières à 35,12 mg/Nm3 (pour une limite à 30) lors du ramonage automatique des catalyseurs de la DENOX.

Rapport DREAL Mensuel Ligne 1

Mensure IC 95 Mensuel L1			Avril 2019											
Unité	CO	COT	HCL	NOx	POUSSIERE	SO2	NH3	Vitesse	O2	T25 L1	MarcheFourL1	Tomage OM L1	Tomage DASRI L1	Ratio Jour L1
VLE Jour	mg/Nm ³	50	mg/Nm ³	10	mg/Nm ³	10	mg/Nm ³	10	%	degreC	hh min ss	Tonnage	Tonnage	-
VLE Max	100	100	20	60	80	150	50	20	15	degreC	hh min ss	Tonnage	Tonnage	-
VLE 1/2h	100	100	20	60	160	30	200	20	15	degreC	hh min ss	Tonnage	Tonnage	-
07/04/2019	6.31	0.99	3.00	0.99	68.13	5.31	1.51	0.94	18.84	9.99	10:4.5	303.9	303.9	1.84
02/04/2019	4.49	3.21	4.49	0.91	65.42	4.96	0.20	4.96	19.14	10.05	10:8.4	247.4	247.4	1.86
03/04/2019	4.57	3.47	3.47	0.86	65.49	5.86	0.13	0.39	19.06	9.89	10:8.4	275.2	275.2	1.18
04/04/2019	4.40	3.31	3.31	0.91	62.63	8.28	0.94	0.26	17.98	9.83	10:8.2	262.7	262.7	7.12
05/04/2019	3.85	2.84	2.84	0.50	62.63	5.20	0.02	0.55	18.76	9.88	10:8.2	285.2	285.2	4.13
06/04/2019	3.49	2.79	2.79	0.25	61.34	6.62	0.00	0.66	19.21	9.88	10:8.9	311.4	311.4	2.25
07/04/2019	3.16	2.75	2.75	0.25	61.50	4.18	0.22	0.60	18.38	10.85	10:8.1	300.8	300.8	0.40
08/04/2019	3.34	3.03	3.03	0.25	61.05	4.47	0.11	0.57	18.91	10.97	10:8.1	302.7	302.7	3.46
09/04/2019	3.61	3.70	3.70	0.30	61.18	3.80	0.97	0.70	18.91	10.82	10:8.2	246.00	246.00	9.1
10/04/2019	3.57	3.31	3.31	0.30	60.95	3.80	0.77	0.70	18.76	10.74	10:8.0	232.3	232.3	3.26
11/04/2019	3.82	3.54	3.54	0.50	60.95	4.14	1.16	0.26	18.62	10.30	10:9.0	288.6	288.6	2.24
12/04/2019	4.02	3.06	3.06	0.61	65.30	6.05	0.34	0.44	18.81	10.15	10:8.1	284.5	284.5	4.99
13/04/2019	3.43	3.06	3.06	0.27	65.47	4.23	0.19	0.40	18.97	11.04	10:9.0	285.1	285.1	6.8
14/04/2019	3.56	3.40	3.40	0.40	64.27	8.07	1.81	0.79	19.40	10.12	11:0.7	295.1	295.1	2.13
15/04/2019	3.57	3.40	3.40	0.34	67.51	5.92	2.75	1.07	19.15	10.14	10:8.6	290.4	290.4	8.47
16/04/2019	3.57	3.70	3.70	0.36	65.41	5.45	2.48	0.82	18.95	10.21	10:8.6	276.3	276.3	9.33
17/04/2019	3.70	0.00	0.00	0.47	66.22	5.36	0.69	0.65	18.85	10.16	10:8.2	237.5	237.5	10.60
18/04/2019	3.04	0.00	0.00	0.31	65.43	3.31	1.14	3.33	18.48	9.97	10:8.7	251.9	251.9	18.06
20/04/2019	3.03	0.00	0.00	0.27	65.64	6.07	3.72	0.92	18.73	10.89	10:8.1	310.6	310.6	15.41
21/04/2019	3.09	0.00	0.00	0.23	65.92	5.78	4.56	1.14	19.20	10.08	10:8.3	209.4	209.4	15.62
22/04/2019	3.25	0.00	0.00	0.22	65.84	4.60	3.11	1.52	19.10	9.71	10:9.1	282.7	282.7	12.33
23/04/2019	3.50	0.00	0.00	0.22	65.79	4.01	3.98	1.39	19.31	9.73	10:8.9	288.3	288.3	6.10
24/04/2019	3.52	0.00	0.00	0.23	65.82	4.37	3.55	0.90	18.98	9.83	11:0.9	246.3	246.3	8.53
25/04/2019	3.50	0.00	0.00	0.23	65.85	5.56	2.67	1.17	19.13	10.05	10:9.4	261.3	261.3	23.4
26/04/2019	3.50	0.29	0.29	0.23	65.72	6.22	2.49	1.75	19.31	10.11	10:11	220.5	220.5	8.64
28/04/2019	3.54	0.27	0.27	0.24	67.01	6.11	3.81	1.97	19.49	10.22	10:9.4	315.3	315.3	7.07
29/04/2019	3.21	0.06	0.06	0.23	65.15	4.34	2.41	1.15	18.95	10.01	10:11	269.4	269.4	2.78
30/04/2019	3.81	0.20	0.20	0.23	62.95	3.29	1.64	1.10	18.11	10.04	10:9.4	211.4	211.4	10.39
Max.	6.31	3.70	3.70	0.99	68.13	8.28	4.56	1.97	19.49	10.30	11:6.7	316.3	316.3	15.62
Rep. VLE Jour	0.00	0.00	0.00	0.22	68.25	3.29	0.00	0.26	17.98	9.71	10:7.6	289.4	289.4	0.00
Nb Jour VLE	0	0	0	0	0	0	0	0	0	0	0	0	0	0
Rep. VLE Max	00:00	00:00	00:00	00:00	00:00	00:00	00:00	00:00	00:00	00:00	00:00	00:00	00:00	00:00
Rep. Scall Min.	0	0	0	0	0	0	0	0	00:00	00:00	00:00	00:00	00:00	00:00
Rep. VLE 1/2h	2	0	0	0	3	2	0	0	18.94	10.03	10:9.7	817.53	817.53	496.7
Moy. Mensuelle	3.94	1.55	1.55	0.40	65.18	5.30	1.64	0.86	18.94	10.03	10:9.7	211.4	211.4	0.00
% données HG	0.00	0.00	0.00	0.00	0.00	0.00	0.00	0.00	0.00	0.00	0.00	0.00	0.00	0.00
% données HC	0.00	0.00	0.00	0.00	0.00	0.00	0.00	0.00	0.00	0.00	0.00	0.00	0.00	0.00
Annuel														

Contrôle réglementaire L1 - 2019	HCL	CO	POUSSIERE	SO2	NOx	COT	NH3	Global
Depassement >4H	0	0	0	0	0	0	0	0
Dep. VLE	0	06:30	02:00	02:00	02:00	05:00	06:00	16:00
Nb jour Invalides	0	0	0	0	0	0	0	0
Nb Jour Coût >100k	0	00:30	00:30	00:30	00:30	00:30	00:30	0
Indisponibilité		00:30	00:30	00:30	00:30	00:30	00:30	02:00
Le 04/04/2019, dépassement d'une moyenne 30' en Poussières à 34,30 mg/Nm3 (pour une limite à 30) lors OAL 2 de l'analyseur effectué par la Sté LECEs (dopage poussière sur la ligne).								
Le 07/04/2019, dépassement d'une moyenne 30' en Poussières à 35,53 mg/Nm3 (pour une limite à 30) lors d'une remontée brutale du débit vapeur.								
Le 20/04/2019, dépassement de deux moyennes 30' en CO à 140,62 mg/Nm3 (pour une limite à 100) suite à une montée brutale du débit vapeur.								
Le 30/04/2019, dépassement de trois moyennes 30' en NOx à 299,38 mg/Nm3, à 366,04 et à 288,43 mg/Nm3 (pour une limite à 160) suite à une mise en sécurité par-bypass de la DENOX.								

Rapport DREAL Mensuel Ligne 1

Mesure IC 95 Mémento L1		Mar 2019													
Unité	CO	COT	HCL	NOX	POUSSIERE	SO2	NH3	Vitesse	O2	T2S L1	Marché out L1	Tonnage OM L1	Tonnage DASRI L1	Ratio Jour L1	
VLE jour	50	50	10	10	80	10	50	m/s	%	degC	kg/mm.ss	Tonne	Tonne	-	
VLE Max	100	100	20	40	160	150	150	10	15						
VLE 17h			20	40	160	30	200	20			850				
01/05/2019	3.80	60.92	0.28	0.37	60.92	5.56	1.37	1.33	19.15	10.24	1101.0	24.000.00	292.0	23.6	
02/05/2019	3.86	61.09	0.44	0.39	61.09	4.45	1.79	1.26	19.29	9.91	1118.3	24.000.00	309.1	19.4	
03/05/2019	3.96	61.62	0.36	0.38	61.62	4.91	2.32	1.29	19.29	9.91	1118.3	24.000.00	309.1	19.4	
04/05/2019	4.12	62.95	0.93	1.90	62.95	8.07	1.90	1.16	18.68	9.93	1087.3	24.000.00	274.0	23.4	
05/05/2019	3.99	60.76	0.80	0.46	60.76	6.81	2.36	1.60	19.23	9.99	1096.3	15390.00	194.2	14.3	
06/05/2019	4.06	61.33	0.75	0.46	61.33	5.64	1.90	1.83	19.20	9.99	1096.3	24.000.00	233.3	7.8	
07/05/2019	4.07	61.16	1.03	0.44	61.16	6.16	1.01	1.72	19.20	10.26	1077.2	24.000.00	235.7	16.0	
08/05/2019	4.00	60.95	1.06	0.42	60.95	5.62	1.83	2.31	19.42	9.76	1088.0	24.000.00	215.8	21.4	
09/05/2019	3.77	64.25	1.22	0.39	64.25	3.74	3.77	1.55	18.95	9.75	259.3	24.000.00	299.3	1.9	
10/05/2019	4.60	75.29	0.92	0.35	75.29	3.93	3.51	1.50	19.29	10.19	1081.0	24.000.00	271.1	3.5	
11/05/2019	4.35	74.74	0.84	0.38	74.74	4.17	2.96	1.41	19.07	10.75	1057.0	24.000.00	323.5	0.48	
12/05/2019	4.06	74.81	0.86	0.37	74.81	3.11	4.17	1.35	19.15	10.75	1065.0	24.000.00	323.5	2.1	
13/05/2019	4.28	68.99	0.78	0.36	68.99	4.32	4.30	1.81	19.38	10.45	1068.3	24.000.00	211.2	2.8	
14/05/2019	4.07	65.79	0.78	0.34	65.79	4.04	2.42	1.74	19.42	10.32	1087.6	24.000.00	190.5	6.30	
15/05/2019	3.85	60.39	0.85	0.34	60.39	3.58	3.20	2.43	19.40	10.18	1089.0	24.000.00	348.1	13.8	
16/05/2019	3.94	65.65	1.01	0.37	65.65	3.37	3.05	1.77	19.33	10.15	1085.6	24.000.00	321.9	3.52	
17/05/2019	4.14	58.94	1.00	0.40	58.94	4.05	2.27	1.70	19.25	10.00	1075.9	24.000.00	321.9	3.89	
18/05/2019	3.91	58.68	1.15	0.41	58.68	3.05	2.80	1.70	18.92	9.64	1089.2	24.000.00	332.2	4.00	
19/05/2019	4.00	58.70	1.53	0.39	58.70	2.94	5.62	1.85	19.02	10.02	1082.3	24.000.00	185.2	0.62	
20/05/2019	3.94	58.52	1.69	0.43	58.52	3.19	6.91	1.68	18.88	9.97	1082.8	24.000.00	215.2	1.2	
21/05/2019	4.01	58.56	1.70	0.47	58.56	5.04	4.15	2.47	19.32	10.28	1076.4	24.000.00	323.7	1.48	
22/05/2019	4.20	57.54	1.67	0.46	57.54	5.95	4.54	2.58	19.45	10.42	1059.0	24.000.00	284.4	8.77	
23/05/2019	4.17	53.75	1.72	0.49	53.75	2.79	3.51	1.75	18.83	10.42	1063.9	24.000.00	284.4	7.25	
24/05/2019	4.80	53.37	1.84	0.56	53.37	1.76	2.81	1.71	18.08	11.01	1039.6	24.000.00	278.4	15.1	
25/05/2019	4.97	52.43	2.21	0.53	52.43	2.10	2.77	0.89	17.17	10.85	1046.9	24.000.00	278.4	17.2	
26/05/2019	3.88	58.65	2.96	0.32	58.65	2.81	1.89	0.82	17.75	10.84	1060.8	24.000.00	343.9	4.8	
27/05/2019	4.54	61.01	2.51	0.57	61.01	1.95	4.43	0.68	18.03	10.75	1063.5	24.000.00	280.9	0.00	
28/05/2019	4.68	61.33	2.39	0.80	61.33	2.77	4.47	0.46	17.55	10.50	1064.4	24.000.00	308.2	8.83	
29/05/2019	5.31	61.61	2.19	0.78	61.61	3.11	2.73	0.51	17.45	11.26	1040.7	24.000.00	272.9	2.22	
30/05/2019	4.85	61.67	2.03	0.70	61.67	5.37	2.76	1.55	18.30	10.86	1053.3	24.000.00	257.3	3.96	
31/05/2019	5.31	75.29	2.96	1.00	75.29	8.07	6.91	2.58	19.48	11.26	1053.3	24.000.00	292.1	11.0	
Max	5.31	75.29	2.96	1.00	75.29	8.07	6.91	2.58	19.48	11.26	1118.3	356.5	185.2	28.4	8.83
Min	3.77	52.43	0.28	0.32	52.43	1.76	1.81	0.38	17.17	9.64	1039.6	0.0	0.0	0.0	0.00
Nb Jour Jrs	0	0	0	0	0	0	0	0	0	0	0	0	0	0	0
Dep VLE jour	0	0	0	0	0	0	0	0	0	0	0	0	0	0	0
Dep VLE Max	00:00	00:00	00:00	00:00	00:00	00:00	00:00	00:00	00:00	00:00	00:00	00:00	00:00	00:00	00:00
Dep-Sort Min.															
Dep VLE 17h	1	0	0	0	0	9	0	0	0	0	0	301 10:57:10	8890.6	306.9	0.0
Moy. Msurée	4.29	61.41	1.24	0.49	61.41	4.30	3.13	1.53	18.91	10.33	1076.1	0.0	6.0	6.0	0.0
% donées HG	0.00	0.00	0.00	0.00	0.00	0.00	0.00	0.00	0.00	0.00	0.0	0.0	6.0	6.0	0.0
% donées HG	0.00	0.00	0.00	0.00	0.00	0.00	0.00	0.00	0.00	0.00	0.0	0.0	6.0	6.0	0.0
Annuel															

Contrôle réglementaire L1 - 2019 HCL										
Dépassement 30'										
CO	NOX	SO2	NH3	VELOC	OT	Global				
01:00	01:00	11:00	02:30	02:00	05:00	02:00				
00:30	00:30	00:30	00:30	00:30	00:30	01:30				
00:30	00:30	00:30	00:30	00:30	00:30	01:30				
00:30	00:30	00:30	00:30	00:30	00:30	01:30				
00:30	00:30	00:30	00:30	00:30	00:30	01:30				
00:30	00:30	00:30	00:30	00:30	00:30	01:30				
00:30	00:30	00:30	00:30	00:30	00:30	01:30				
00:30	00:30	00:30	00:30	00:30	00:30	01:30				
00:30	00:30	00:30	00:30	00:30	00:30	01:30				
00:30	00:30	00:30	00:30	00:30	00:30	01:30				

* Le 07/05/2019, dépassement d'une moyenne 30' en Poussières à 38,13 mg/Nm3 (pour une limite à 30) suite à une élévation de la vitesse du ventilateur de tirage (moyenne 1150 tr/min).

* Le 04/05/2019, dépassement d'une moyenne 30' en Poussières à 32,76 mg/Nm3 (pour une limite à 30) suite à une élévation de la vitesse du ventilateur de tirage (moyenne 1150 tr/min).

* Le 07/05/2019, dépassement d'une moyenne 30' en Poussières à 34,11 mg/Nm3 (pour une limite à 30) suite à une élévation de la vitesse du ventilateur de tirage (moyenne 1150 tr/min).

* Le 08/05/2019, dépassement d'une moyenne 30' en Poussières à 50,58 mg/Nm3 (pour une limite à 30) suite à une élévation de la vitesse du ventilateur de tirage (moyenne 1150 tr/min).

* Le 11/05/2019, dépassement d'une moyenne 30' en Poussières à 41,96 mg/Nm3 (pour une limite à 30) suite à une élévation de la vitesse du ventilateur de tirage (moyenne 1150 tr/min).

* Le 24/05/2019, dépassement d'une moyenne 30' en Poussières à 38,22 mg/Nm3 (pour une limite à 30) lors de la remontée de la charge du four.

* Le 25/05/2019, dépassement d'une moyenne 30' en CO à 134,44 mg/Nm3 (pour une limite à 100) suite à un excès d'air dans le four.

* Le 30/05/2019, dépassement d'une moyenne 30' en Poussières à 37,24 mg/Nm3 (pour une limite à 30) lors d'une remontée brutale de la charge du four.

* Le 31/05/2019, dépassement de deux moyennes 30' en Poussières à 31,87 mg/Nm3 et à 43,67 mg/Nm3 (pour une limite à 30) lors d'une remontée brutale de la charge du four.

Rapport DREAL Mensuel Ligne 1

Mesure IC 95 Mensuel L1															Juin 2019	
CO	COT	HCL	NOx	POUSSIERE	SO2	NH3	Vitesse	O2	TSS L1	Marche/out.L1	Tonnage OM L1	Tonnage DASRI L1	Rabot Jour L1			
Unité mg/Nm3	mg/Nm3	mg/Nm3	mg/Nm3	mg/Nm3	mg/Nm3	mg/Nm3	m/s	%	degreC	hh:mm:ss	Tonnage	Tonnage				
VLE Jour	VLE Jour	VLE Jour	VLE Jour	VLE Jour	VLE Jour	VLE Jour	VLE Jour	VLE Jour	VLE Jour	VLE Jour	VLE Jour	VLE Jour				
Seuil Min.	Seuil Min.	Seuil Min.	Seuil Min.	Seuil Min.	Seuil Min.	Seuil Min.	Seuil Min.	Seuil Min.	Seuil Min.	Seuil Min.	Seuil Min.	Seuil Min.				
VLE 17h	VLE 17h	VLE 17h	VLE 17h	VLE 17h	VLE 17h	VLE 17h	VLE 17h	VLE 17h	VLE 17h	VLE 17h	VLE 17h	VLE 17h				
01/06/2019	4.82	2.11	0.55	61.94	4.18	2.86	1.95	19.34	10.21	14:24:20	92.9	0.0	0.00			
02/06/2019	Arret	Arret	Arret	Arret	Arret	Arret	Arret	Arret	Arret	00:00:00	0.0	0.0	0.00			
03/06/2019	Arret	Arret	Arret	Arret	Arret	Arret	Arret	Arret	Arret	00:00:00	0.0	0.0	0.00			
04/06/2019	Indisponible	Indisponible	Indisponible	Indisponible	Indisponible	Indisponible	Indisponible	Indisponible	Indisponible	00:00:00	0.0	0.0	0.00			
05/06/2019	Arret	Arret	Arret	Arret	Arret	Arret	Arret	Arret	Arret	00:00:00	0.0	0.0	0.00			
06/06/2019	Arret	Arret	Arret	Arret	Arret	Arret	Arret	Arret	Arret	00:00:00	0.0	0.0	0.00			
07/06/2019	Arret	Arret	Arret	Arret	Arret	Arret	Arret	Arret	Arret	00:00:00	0.0	0.0	0.00			
08/06/2019	Arret	Arret	Arret	Arret	Arret	Arret	Arret	Arret	Arret	00:00:00	0.0	0.0	0.00			
09/06/2019	Arret	Arret	Arret	Arret	Arret	Arret	Arret	Arret	Arret	00:00:00	0.0	0.0	0.00			
10/06/2019	Arret	Arret	Arret	Arret	Arret	Arret	Arret	Arret	Arret	00:00:00	0.0	0.0	0.00			
11/06/2019	Arret	Arret	Arret	Arret	Arret	Arret	Arret	Arret	Arret	00:00:00	0.0	0.0	0.00			
12/06/2019	Arret	Arret	Arret	Arret	Arret	Arret	Arret	Arret	Arret	00:00:00	0.0	0.0	0.00			
13/06/2019	Arret	Arret	Arret	Arret	Arret	Arret	Arret	Arret	Arret	00:00:00	0.0	0.0	0.00			
14/06/2019	Arret	Arret	Arret	Arret	Arret	Arret	Arret	Arret	Arret	00:00:00	0.0	0.0	0.00			
15/06/2019	Arret	Arret	Arret	Arret	Arret	Arret	Arret	Arret	Arret	00:00:00	0.0	0.0	0.00			
16/06/2019	Arret	Arret	Arret	Arret	Arret	Arret	Arret	Arret	Arret	00:00:00	0.0	0.0	0.00			
17/06/2019	Arret	Arret	Arret	Arret	Arret	Arret	Arret	Arret	Arret	00:00:00	0.0	0.0	0.00			
18/06/2019	Arret	Arret	Arret	Arret	Arret	Arret	Arret	Arret	Arret	00:00:00	0.0	0.0	0.00			
19/06/2019	Arret	Arret	Arret	Arret	Arret	Arret	Arret	Arret	Arret	00:00:00	0.0	0.0	0.00			
20/06/2019	Arret	Arret	Arret	Arret	Arret	Arret	Arret	Arret	Arret	00:00:00	0.0	0.0	0.00			
21/06/2019	Arret	Arret	Arret	Arret	Arret	Arret	Arret	Arret	Arret	00:00:00	0.0	0.0	0.00			
22/06/2019	Arret	Arret	Arret	Arret	Arret	Arret	Arret	Arret	Arret	00:00:00	0.0	0.0	0.00			
23/06/2019	Arret	Arret	Arret	Arret	Arret	Arret	Arret	Arret	Arret	00:00:00	0.0	0.0	0.00			
24/06/2019	Arret	Arret	Arret	Arret	Arret	Arret	Arret	Arret	Arret	00:00:00	0.0	0.0	0.00			
25/06/2019	Arret	Arret	Arret	Arret	Arret	Arret	Arret	Arret	Arret	00:00:00	0.0	0.0	0.00			
26/06/2019	Arret	Arret	Arret	Arret	Arret	Arret	Arret	Arret	Arret	00:00:00	0.0	0.0	0.00			
27/06/2019	Arret	Arret	Arret	Arret	Arret	Arret	Arret	Arret	Arret	00:00:00	0.0	0.0	0.00			
28/06/2019	Arret	Arret	Arret	Arret	Arret	Arret	Arret	Arret	Arret	00:00:00	0.0	0.0	0.00			
29/06/2019	Arret	Arret	Arret	Arret	Arret	Arret	Arret	Arret	Arret	00:00:00	0.0	0.0	0.00			
30/06/2019	Arret	Arret	Arret	Arret	Arret	Arret	Arret	Arret	Arret	00:00:00	0.0	0.0	0.00			
31/06/2019	Arret	Arret	Arret	Arret	Arret	Arret	Arret	Arret	Arret	00:00:00	0.0	0.0	0.00			
Max	4.82	2.11	0.55	61.94	4.18	2.86	1.95	19.34	10.21	1074.9	92.9	0.0	0.00			
Min	4.82	2.11	0.55	61.94	4.18	2.86	1.95	19.34	10.21	1074.9	92.9	0.0	0.00			
Dep. VLE jour	0	0	0	0	0	0	0	0	0	0	0	0	0			
Nb Jour	9	1	1	1	1	1	1	1	1	1	0	0	0			
Dep. VLE Max	00:00	00:30	00:00	00:00	00:00	00:00	00:00	00:00	00:00	00:00	00:00	00:00	00:00			
Dep. Seuil Min.																
Dep. VLE 17h	0	0	0	0	0	0	0	0	0	0	0	0	0			
Moy. Mensuelle	4.82	2.11	0.55	61.94	4.18	2.86	1.95	19.34	10.21	1074.9	92.9	0.0	0.00			
% domence HG	0.00	0.00	0.00	0.00	0.00	0.00	0.00	0.00	0.00	0.00	0.00	0.00	0.00			
% domence HG	0.00	0.00	0.00	0.00	0.00	0.00	0.00	0.00	0.00	0.00	0.00	0.00	0.00			
Annexe																

* Le 01/06/2019, dépassement d'une moyenne 30 en Poussières à 30,75 mg/Nm³ (pour une limite à 30) lors de l'arrêt du chargement du four.
 * Le 04/06/2019, coupure électrique EDF lors de l'arrêt technique lignes EME

Rapport DREAL Mensuel Ligne 1

Rapport Mensuel															Juillet 2019	
Mesure IC 95 Mensuel L1																
CO	COT	HCL	NOX	POUSSIÈRE	SO2	NH3	Vitesse	O2	T2S L1	MancheFour.1	Tonnage OML1	Tonnage DASRL1	Ratio four L1			
mg/Nm3	mg/Nm3	mg/Nm3	mg/Nm3	mg/Nm3	mg/Nm3	mg/Nm3	m/s	%	degreC	lh.mmn.ss	Tonnage	Tonnage				
VLE Max	VLE Max	VLE Max	VLE Max	VLE Max	VLE Max	VLE Max	VLE Max	VLE Max	VLE Max	VLE Max	VLE Max	VLE Max				
100	100	20	10	80	10	50	10	15	850	850	850	850				
01/07/2019	Arrêt	Arrêt	Arrêt	Arrêt	Arrêt	Arrêt	Arrêt	Arrêt	Arrêt	00:00:00	0.0	0.0	0.00			
02/07/2019	Arrêt	Arrêt	Arrêt	Arrêt	Arrêt	Arrêt	Arrêt	Arrêt	Arrêt	00:00:00	0.0	0.0	0.00			
03/07/2019	Arrêt	Arrêt	Arrêt	Arrêt	Arrêt	Arrêt	Arrêt	Arrêt	Arrêt	00:00:00	0.0	0.0	0.00			
04/07/2019	Arrêt	Arrêt	Arrêt	Arrêt	Arrêt	Arrêt	Arrêt	Arrêt	Arrêt	00:00:00	0.0	0.0	0.00			
05/07/2019	Arrêt	Arrêt	Arrêt	Arrêt	Arrêt	Arrêt	Arrêt	Arrêt	Arrêt	00:00:00	0.0	0.0	0.00			
06/07/2019	Arrêt	Arrêt	Arrêt	Arrêt	Arrêt	Arrêt	Arrêt	Arrêt	Arrêt	00:00:00	0.0	0.0	0.00			
07/07/2019	Arrêt	Arrêt	Arrêt	Arrêt	Arrêt	Arrêt	Arrêt	Arrêt	Arrêt	00:00:00	0.0	0.0	0.00			
08/07/2019	Arrêt	Arrêt	Arrêt	Arrêt	Arrêt	Arrêt	Arrêt	Arrêt	Arrêt	00:00:00	0.0	0.0	0.00			
09/07/2019	Arrêt	Arrêt	Arrêt	Arrêt	Arrêt	Arrêt	Arrêt	Arrêt	Arrêt	00:00:00	0.0	0.0	0.00			
10/07/2019	Arrêt	Arrêt	Arrêt	Arrêt	Arrêt	Arrêt	Arrêt	Arrêt	Arrêt	00:00:00	0.0	0.0	0.00			
11/07/2019	Arrêt	Arrêt	Arrêt	Arrêt	Arrêt	Arrêt	Arrêt	Arrêt	Arrêt	00:00:00	0.0	0.0	0.00			
12/07/2019	Arrêt	Arrêt	Arrêt	Arrêt	Arrêt	Arrêt	Arrêt	Arrêt	Arrêt	00:00:00	0.0	0.0	0.00			
13/07/2019	Arrêt	Arrêt	Arrêt	Arrêt	Arrêt	Arrêt	Arrêt	Arrêt	Arrêt	00:00:00	0.0	0.0	0.00			
14/07/2019	Arrêt	Arrêt	Arrêt	Arrêt	Arrêt	Arrêt	Arrêt	Arrêt	Arrêt	00:00:00	0.0	0.0	0.00			
15/07/2019	Arrêt	Arrêt	Arrêt	Arrêt	Arrêt	Arrêt	Arrêt	Arrêt	Arrêt	00:00:00	0.0	0.0	0.00			
16/07/2019	23.04	5.05	0.71	3.83	0.00	0.01	0.01	13.91	11.09	05:22:30	0.0	0.0	0.00			
17/07/2019	19.72	3.36	0.62	6.54	0.00	0.00	0.10	17.39	11.72	23:29:20	0.0	0.0	0.00			
18/07/2019	17.47	3.16	0.63	3.23	0.00	0.00	0.08	18.44	11.07	03:19:00	0.0	0.0	0.00			
19/07/2019	18.30	3.16	0.55	59.42	0.00	0.01	0.06	17.68	11.72	23:29:20	0.0	0.0	0.00			
20/07/2019	17.19	3.15	0.99	57.18	0.00	0.00	0.08	18.44	11.07	03:19:00	0.0	0.0	0.00			
21/07/2019	17.74	3.18	1.23	2.99	0.00	0.00	0.10	14.98	10.72	24:00:00	0.0	0.0	0.00			
22/07/2019	16.52	2.82	1.19	57.09	0.00	0.00	0.07	19.00	11.07	24:00:00	0.0	0.0	0.00			
23/07/2019	15.70	2.60	1.28	3.09	0.00	0.00	0.09	18.88	10.89	24:00:00	0.0	0.0	0.00			
24/07/2019	15.16	2.35	1.59	3.06	0.00	0.00	0.11	18.84	11.02	24:00:00	0.0	0.0	0.00			
25/07/2019	11.07	1.79	1.21	2.77	0.00	0.01	0.08	12.16	10.53	24:00:00	0.0	0.0	0.00			
26/07/2019	10.56	4.69	1.09	46.83	0.00	0.00	0.06	14.66	10.53	24:00:00	0.0	0.0	0.00			
27/07/2019	17.09	8.31	1.14	63.95	0.00	0.13	0.13	19.27	10.53	24:00:00	0.0	0.0	0.00			
28/07/2019	16.84	7.48	1.28	2.86	0.00	13.77	0.08	18.72	10.66	24:00:00	0.0	0.0	0.00			
29/07/2019	16.01	7.06	1.23	65.18	0.00	6.70	0.14	17.41	11.30	24:00:00	0.0	0.0	0.00			
30/07/2019	17.11	7.68	1.46	64.84	0.00	2.72	0.15	18.59	10.98	24:00:00	0.0	0.0	0.00			
31/07/2019	17.58	8.19	1.37	65.47	0.00	3.86	0.08	17.61	11.51	24:00:00	0.0	0.0	0.00			
Max.	23.04	5.31	1.59	65.47	0.00	21.61	0.15	19.27	14.66	1688.5	341.3	11.6	3.91			
Min.	10.56	1.79	0.55	46.83	0.00	0.00	0.01	11.37	10.53	919.7	6.0	0.0	0.80			
Dep. VLE jour	0	0	0	0	0	0	0	0	0	0	0	0	0			
Nb. Jour Jours.	0	0	0	0	0	0	0	0	0	0	0	0	0			
Dep. VLE Max	00:00	00:00	0	00:00	0	0	0	0	0	0	0	0	0			
Dep. Scat Min.	0	0	0	0	0	0	0	0	0	0	0	0	0			
Dep. VLE 1/2h	1	0	0	1	0	0	0	0	0	0	0	0	0			
Moy. Mensuelle	16.52	4.62	1.12	59.16	0.00	6.65	0.09	17.50	11.38	964.4	2312.3	32.6	1.41			
% donnees HG	0.00	0.00	0.00	0.00	0.00	0.00	0.00	0.00	0.00	0.0	0.0	0.0	0.00			
% donnees HG	0.00	0.00	0.00	0.00	0.00	0.00	0.00	0.00	0.00	0.0	0.0	0.0	0.00			
Annuel																

Contraint réglementaire L1 - 2019 [HCL]														
POUSSIÈRE														
ICO														
NON														
NH3														
Gmbal														
Depassement >H	0	0	0	0	0	0	0	0	0	0	0	0	0	
Dep. VLE	01:00	11:30	1	03:00	02:00	0	05:30	0	05:30	00:00	02:00	0	24:00	
Nb. Jour. Incalculés	1	1	1	1	1	1	1	1	1	1	1	1	1	
Jours. Cons>10h	0	0	0	0	0	0	0	0	0	0	0	0	0	
Inadaptabilité	06:00	06:00	06:00	06:00	06:00	06:00	06:00	06:00	06:00	06:00	06:00	06:00	07:30	

* Le 16/07/2019, dépassement d'une moyenne 30' en CO à 123.20 mg/Nm3 (pour une limite à 100) et en NOx à 215.06 mg/Nm3 (pour une limite à 160) au moment du chargement du four en OM.

Rapport DREAL Mensuel Ligne 1

Mensuel IC 95 Mensuel L1		Aout 2019												
Unité	CO	COT	HCL	NOX	POUSSIERE	SO2	NH3	Vitesse	O2	TSS L1	Marcheur L1	Tonnage OML1	Tonnage DASRI L1	Ratio Jour L1
VLE Jour	50	100	10	10	80	10	50	m/s	%	degréC	h/m.m.ss	Tonnage	Tonnage	
VLE Max	100	100	20	60	160	150	200	10	15		850			
VLE 1/2h	100	100	20	60	160	30	200	20						
01/08/2019	14.69	4.39	0.78	0.78	67.10	0.71	0.28	0.71	18.60	11.09	577.2	24.00.00	269.8	2.3
02/08/2019	13.26	1.38	0.53	0.53	61.25	0.53	0.01	0.19	19.25	10.61	925.1	23.58.20	305.7	0.1
03/08/2019	12.07	1.72	0.73	0.73	61.19	0.16	1.89	0.16	19.65	10.75	982.5	24.00.00	238.8	0.0
04/08/2019	13.47	1.72	0.82	0.82	57.64	4.20	1.88	0.13	18.88	10.93	984.1	16.19.00	161.9	0.0
05/08/2019	Arret	Arret	Arret	Arret	Arret	Arret	Arret	Arret	Arret	Arret	Arret	00.00.00	3.1	0.0
06/08/2019	Arret	Arret	Arret	Arret	Arret	Arret	Arret	Arret	Arret	Arret	Arret	00.00.00	0.0	0.0
07/08/2019	13.94	3.85	0.86	0.86	65.57	0.00	0.00	0.16	17.76	10.98	970.3	03.13.50	76.9	0.0
08/08/2019	12.38	2.74	1.19	0.98	57.02	5.33	1.51	0.18	18.54	10.43	990.4	24.00.00	359.9	0.0
09/08/2019	11.92	2.53	1.19	1.19	57.04	6.24	1.51	0.24	18.54	9.52	1003.1	24.00.00	332.2	0.0
10/08/2019	12.39	2.31	1.52	1.39	59.34	7.85	1.52	0.08	19.11	10.60	982.0	22.23.10	334.2	0.0
11/08/2019	12.85	2.34	1.69	1.39	56.74	7.46	0.98	0.04	19.52	10.60	989.0	24.00.00	351.6	0.0
12/08/2019	11.66	2.25	1.31	1.31	61.50	8.78	2.63	0.09	17.65	10.81	978.5	23.57.00	360.4	0.80
13/08/2019	12.83	2.17	1.72	1.72	61.35	8.26	6.31	0.18	18.10	10.73	991.3	24.00.00	339.1	4.2
14/08/2019	11.44	2.09	1.61	1.61	61.05	8.07	5.27	0.26	18.28	10.83	1067.7	24.00.00	363.6	0.0
15/08/2019	11.25	1.58	1.58	1.58	60.88	8.23	18.52	0.04	18.52	10.93	1067.7	24.00.00	363.6	0.0
16/08/2019	11.47	2.50	1.38	1.38	61.06	9.11	0.14	0.12	18.62	10.17	1016.3	24.00.00	317.5	0.0
17/08/2019	10.39	2.28	1.36	1.36	61.17	6.69	1.17	0.07	17.85	9.14	1033.2	24.00.00	266.4	0.0
18/08/2019	10.43	2.04	1.30	1.30	61.18	7.99	0.00	0.02	18.49	10.25	1039.2	24.00.00	266.4	0.0
19/08/2019	10.05	1.97	1.28	1.28	60.85	7.91	0.00	0.05	18.08	10.25	1023.9	24.00.00	288.8	3.3
20/08/2019	10.38	1.97	1.23	1.23	61.59	7.91	0.00	0.03	18.37	10.39	1012.5	24.00.00	305.6	23.4
21/08/2019	10.76	1.88	1.19	1.19	61.07	7.84	0.70	0.15	18.57	10.36	1029.4	24.00.00	325.2	24.0
22/08/2019	9.92	1.94	1.45	1.45	61.02	7.95	1.81	0.02	18.34	10.28	1069.3	24.00.00	299.8	8.17
23/08/2019	10.05	1.95	1.56	1.56	61.61	6.16	3.38	0.23	18.86	10.25	1069.3	24.00.00	299.8	24.5
24/08/2019	9.91	1.96	1.72	1.72	61.09	8.77	1.91	0.02	19.08	10.66	1062.9	24.00.00	356.6	3.42
25/08/2019	9.40	1.87	1.60	1.60	61.09	7.39	1.47	0.11	18.46	9.95	1065.0	24.00.00	325.7	6.5
26/08/2019	9.25	2.05	1.47	1.47	61.06	8.11	1.05	0.04	18.46	9.95	1065.0	24.00.00	285.2	2.00
27/08/2019	9.50	2.11	1.25	1.25	63.96	6.34	0.53	0.04	17.86	10.25	971.4	24.00.00	296.7	17.0
28/08/2019	11.21	2.42	0.96	0.96	64.04	8.59	1.03	0.06	17.36	10.64	983.3	23.53.40	248.8	8.5
29/08/2019	9.82	2.14	1.16	1.16	64.01	8.28	1.04	0.02	17.36	10.44	981.3	24.00.00	275.4	24.9
30/08/2019	9.69	2.26	1.16	1.16	63.43	8.19	1.14	0.02	18.64	10.81	984.2	24.00.00	249.6	17.0
31/08/2019	14.69	4.39	1.72	1.72	67.10	9.11	6.31	0.71	19.65	11.09	1033.0	24.00.00	315.2	15.3
Max.	9.40	1.88	0.53	0.53	56.74	2.82	0.00	0.02	17.30	9.14	970.3	345.6	0.0	9.84
Dep. VLE Jour	0	0	0	0	0	0	0	0	0	0	0	0.0	0.0	0.00
Nb Jour Jora.	0	0	0	0	0	0	0	0	0	0	0	0	0	0
Dep. VLE Max	00:00	00:00	00:00	00:00	00:00	00:00	00:00	00:00	00:00	00:00	00:00	00:00	00:00	00:00
Dep. Scall Min.	0	0	0	0	0	0	0	0	0	0	0	0	0	0
Dep. VLE 1/2h	0	1	0	0	0	0	0	5	0	0	0	0	0	0
Moy. Mensuelle	11.24	2.25	1.29	1.29	61.05	7.26	1.57	0.25	18.50	10.35	1000.5	271 15:17:00	8658.0	218.1
% données HG	0.00	0.00	0.00	0.00	0.00	0.00	0.00	0.00	0.00	0.00	0.0	0	0.0	0.0
% données HG	0.00	0.00	0.00	0.00	0.00	0.00	0.00	0.00	0.00	0.00	0.0	0	0.0	0.0
Annuel														

Contrôle réglementaire L1 - 2019 VLE										
Dépassement >4H										
Dép. VLE	CO	POUSSIERE	SO2	NOX	COT	NH3	CO	CO2	CO	CO2
Nb jour antérieures	0	1	1	1	1	1	1	1	1	1
Indice Com >10h	0	0	0	0	0	0	0	0	0	0
Indisponibilité	0	0	0	0	0	0	0	0	0	0
Dép. VLE	0	0	0	0	0	0	0	0	0	0
Nb jour antérieures	01:00	11:30	03:00	02:00	05:30	00:30	04:30	00:30	04:30	27:00
Indice Com >10h	0	0	0	0	0	0	0	0	0	0
Indisponibilité	06:00	06:00	06:00	06:00	06:00	06:00	06:00	06:00	06:00	07:30

* Le 01/08/2019, dépassement de 5 moyennes 30' en NH3 à 25.92 mg/Nm3, 31.59 mg/Nm3, 62.46 mg/Nm3, 46.40 mg/Nm3 et 21.45 mg/Nm3 (pour une limite à 20) suite à la mise à l'arrêt sur sécurité du brûleur DeNOx (maintenance curative pour réglage de la vanne de régulation en gaz naturel).
 • Le 04/08/2019, dépassement d'une moyenne 30' en COT à 50.57 mg/Nm3 (pour une limite à 20) suite à un excès d'air sur la fin de la combustion lors de la mise à l'arrêt de la ligne.

Rapport DREAL Mensuel Ligne 1

Rapport Mensuel															Septembre 2019	
Mesure (C-95) Mensuel L1																
Unité	CO	COT	HCL	NOX	POUSSIERE	SO2	NH3	Vitesse	O2	TZS L1	MarcheFourL1	Toussage OM L1	Toussage DASRI L1	Rabo Jour L1		
VLE Jour	50	100	10	10	90	10	50	m/s	%	degC	hh:mm:ss	Toussage	Toussage			
VLE Max	100	200	20	60	160	150	200	10	15	degC	hh:mm:ss	Toussage	Toussage			
VLE 1/2h	100	200	20	60	160	150	200	20	15	degC	hh:mm:ss	Toussage	Toussage			
01/09/2019	9,76	2,29	1,02	8,14	3,14	1,31	0,10	10,12	18,99	10,12	10,10,6	24,00,00	374,0	7,0		
02/09/2019	9,66	2,18	1,10	8,11	3,10	1,29	0,10	10,13	18,47	10,13	10,15,9	24,00,00	374,0	1,7		
03/09/2019	10,16	2,37	1,10	8,00	3,10	1,29	0,23	10,20	18,29	10,20	10,10,2	24,00,00	396,4	21,4		
04/09/2019	10,46	2,39	1,21	8,19	3,12	1,31	0,04	10,20	18,03	10,20	10,10,2	24,00,00	298,3	2,1		
05/09/2019	10,58	2,35	1,09	8,19	3,12	1,31	0,07	10,25	18,72	10,25	10,10,2	24,00,00	254,4	22,0		
06/09/2019	9,98	2,44	1,10	8,14	3,12	1,31	0,01	10,24	17,94	10,24	10,15,9	24,00,00	271,9	24,3		
07/09/2019	10,98	2,40	1,18	8,14	3,12	1,31	0,16	10,16	17,19	10,16	10,15,9	24,00,00	286,3	20,9		
08/09/2019	11,27	2,56	1,08	8,14	3,12	1,31	0,02	10,22	18,28	10,22	10,15,9	24,00,00	280,2	7,7		
09/09/2019	11,58	2,39	1,20	8,29	3,12	1,31	0,02	10,22	18,05	10,22	10,15,9	24,00,00	303,3	6,3		
10/09/2019	11,01	2,30	1,80	8,94	3,12	1,31	0,06	10,10	18,54	10,10	10,15,9	24,00,00	308,1	17,3		
11/09/2019	10,72	2,30	1,31	8,94	3,12	1,31	0,11	10,10	18,35	10,10	10,15,9	24,00,00	345,7	6,2		
12/09/2019	11,67	2,71	1,20	8,94	3,12	1,31	0,02	10,10	18,33	10,10	10,15,9	24,00,00	334,8	4,1		
13/09/2019	11,60	2,79	1,20	8,94	3,12	1,31	0,01	10,10	18,11	10,10	10,15,9	24,00,00	319,2	8,3		
14/09/2019	11,91	2,42	1,20	8,94	3,12	1,31	0,23	10,22	17,99	10,22	10,15,9	24,00,00	290,9	21,1		
15/09/2019	10,80	2,26	1,19	8,88	3,12	1,31	0,07	10,24	18,64	10,24	10,15,9	24,00,00	312,6	0,0		
16/09/2019	12,73	2,50	1,01	8,88	3,12	1,31	0,11	10,31	18,55	10,31	10,15,9	24,00,00	327,1	0,0		
17/09/2019	11,94	2,56	0,82	8,88	3,12	1,31	0,13	10,27	18,54	10,27	10,15,9	24,00,00	246,5	6,9		
18/09/2019	10,86	2,38	0,82	8,88	3,12	1,31	0,01	10,27	17,76	10,27	10,15,9	24,00,00	254,8	5,0		
19/09/2019	12,91	3,00	0,91	8,88	3,12	1,31	0,05	10,24	18,55	10,24	10,15,9	24,00,00	277,8	13,6		
20/09/2019	12,67	2,95	0,99	8,88	3,12	1,31	0,28	10,24	18,46	10,24	10,15,9	24,00,00	255,8	20,0		
21/09/2019	11,80	2,97	1,12	8,85	3,12	1,31	0,02	10,24	18,55	10,24	10,15,9	24,00,00	326,6	5,4		
22/09/2019	11,71	3,54	1,01	8,85	3,12	1,31	0,03	10,24	18,52	10,24	10,15,9	24,00,00	364,8	0,2		
23/09/2019	12,05	3,65	0,95	8,85	3,12	1,31	0,14	10,22	18,43	10,22	10,15,9	24,00,00	328,8	0,0		
24/09/2019	11,84	3,56	0,92	8,85	3,12	1,31	0,11	10,22	18,53	10,22	10,15,9	24,00,00	327,7	7,0		
25/09/2019	12,70	3,46	2,50	8,85	3,12	1,31	0,13	10,22	18,77	10,22	10,15,9	24,00,00	327,7	0,0		
26/09/2019	13,00	3,42	2,05	8,88	3,12	1,31	0,16	10,22	18,34	10,22	10,15,9	24,00,00	295,0	4,8		
27/09/2019	12,87	3,47	2,26	8,88	3,12	1,31	0,10	10,22	18,73	10,22	10,15,9	24,00,00	305,4	6,9		
28/09/2019	12,59	3,35	2,05	8,88	3,12	1,31	0,07	10,22	18,16	10,22	10,15,9	24,00,00	285,1	2,3		
29/09/2019	12,32	3,35	1,93	8,88	3,12	1,31	0,05	10,22	18,48	10,22	10,15,9	24,00,00	263,3	6,6		
30/09/2019	11,86	3,30	1,89	8,88	3,12	1,31	0,11	10,22	18,08	10,22	10,15,9	24,00,00	344,7	0,8		
Max	13,00	3,65	3,44	9,14	3,12	1,31	0,30	10,24	18,99	10,24	10,15,9	24,00,00	374,0	24,3		
Dep. VLE Jour	9,66	2,18	1,10	8,11	3,10	1,29	0,10	10,12	17,19	10,12	10,10,6	24,00,00	256,3	0,0		
Nb Jour Exe.	0	0	0	0	0	0	0	0	0	0	0	0	0	0		
Dep. VLE Max	00:00	00:00	00:00	00:00	00:00	00:00	0	0	0	0	0	0	0	0		
Dep. VLE Min.	0	0	0	0	0	0	0	0	0	0	0	0	0	0		
Dep. VLE 1/2h	2	0	0	2	0	0	0	0	0	0	0	0	0	0		
Moy. Mensuelle	11,73	2,81	1,39	8,82	3,12	1,31	0,09	10,30	18,28	10,30	10,17,1	29,31:56:00	916,3	308,9		
% données HG	0,00	0,00	0,00	0,00	0,00	0,00	0,00	0,00	0,00	0,00	0,00	0,00	0,00	0,00		
% données HG	0,00	0,00	0,00	0,00	0,00	0,00	0,00	0,00	0,00	0,00	0,00	0,00	0,00	0,00		
Annuel																

Contrôle réglementaire L1 - 2019 HCL														
Dépassement >4H														
Dép. VLE	CO	SO2	NOx	COV	NH3	Global								
Nb jour mesurés	0	0	0	0	0	0								
Incis. Cons >10h	0	0	0	0	0	0								
Indisponibilité	07:30	07:30	07:30	07:30	07:30	07:30								
06/09/2019	0	0	0	0	0	0								
17/09/2019	01:00	04:00	02:00	06:00	00:30	04:30								
23/09/2019	0	0	0	0	0	0								
25/09/2019	07:30	07:30	07:30	07:30	07:30	07:30								

* Le 06/09/2019, dépassement d'une moyenne 30' en CO à 186,77 mg/Nm³ (pour une limite à 100) suite à une explosion dans le four.
 * Le 17/09/2019, dépassement de deux moyennes 30' en Poussières à 35,22 mg/Nm³ et à 37,16 mg/Nm³ (pour une limite à 30) suite à la perte de la garde d'eau de l'extracteur mâchefer.
 * Le 23/09/2019, dépassement d'une moyenne 30' en CO à 118,60 mg/Nm³ (pour une limite à 100) suite à une explosion dans le four.
 * Le 25/09/2019, dépassement d'une moyenne 30' en NOx à 260,51 mg/Nm³ (pour une limite à 160) suite à défaut du brûleur DeNOx et de l'injection ammoniacale

Rapport DREAL Mensuel Ligne 1

Mésure : IC 95 Mensuel L1		Rabot Jour L1												
Unités	CO	COT	HCL	NOX	POUSSIERE	SO2	NH3	Visesse	O2	TS L1	Marché-Poul L1	Tonnage OM L1	Tonnage DASRL L1	Rabot Jour L1
VLE Jour	mg/Nm3	mg/Nm3	mg/Nm3	mg/Nm3	mg/Nm3	mg/Nm3	mg/Nm3	m/s	%	degréC	kh.m.m.s	Tonnac	Tonnac	
VLE Max	50	80	10	10	80	10	50	10	15		850			
VLE 1/2h	100	100	20	60	160	30	200	30						
01/10/2019	12,12	64,72	3,52	1,96	64,72	7,62	5,60	10,10	18,74	10,10	1090,5	2400,00	341,0	4,8
02/10/2019	12,44	65,88	3,11	1,96	65,88	1,32	5,36	10,10	18,74	10,10	1090,5	2400,00	309,4	4,1
03/10/2019	11,17	65,51	3,29	1,70	65,51	2,24	5,65	10,19	18,74	10,19	1012,7	2400,00	315,4	15,6
04/10/2019	11,32	66,31	3,29	1,70	66,31	6,49	6,30	10,19	18,74	10,19	1012,7	2400,00	272,6	3,1
05/10/2019	11,89	66,31	2,89	1,46	66,31	5,88	5,57	10,32	18,77	10,32	1010,5	2400,00	354,9	0,0
06/10/2019	10,28	64,39	3,56	1,20	64,39	6,32	6,32	10,32	18,74	10,32	1010,5	2400,00	384,1	0,0
07/10/2019	11,87	63,15	4,06	1,13	63,15	6,53	5,71	10,10	18,74	10,10	1010,5	2400,00	300,7	3,39
08/10/2019	11,79	63,15	3,86	0,89	63,15	7,18	7,70	10,10	18,74	10,10	1010,5	2400,00	356,9	2,94
09/10/2019	11,68	63,15	3,52	0,76	63,15	5,79	9,21	10,00	18,74	10,00	1010,5	2400,00	311,4	12,8
10/10/2019	11,49	63,90	3,48	0,58	63,90	4,83	4,83	10,00	18,74	10,00	1010,5	2400,00	307,3	15,9
11/10/2019	10,14	64,64	3,35	0,33	64,64	5,65	6,30	10,16	18,74	10,16	1010,5	2400,00	306,3	24,0
12/10/2019	10,44	64,64	3,35	0,22	64,64	6,21	7,28	10,16	18,74	10,16	1010,5	2400,00	317,7	5,48
13/10/2019	9,75	63,55	3,22	0,54	63,55	4,66	9,60	10,16	18,74	10,16	1010,5	2400,00	293,7	3,85
14/10/2019	10,10	63,55	3,44	0,84	63,55	5,29	9,83	10,16	18,74	10,16	1010,5	2400,00	264,9	15,9
15/10/2019	10,70	63,55	3,79	1,05	63,55	7,97	7,52	10,27	18,74	10,27	1023,9	2400,00	293,7	25,7
16/10/2019	10,43	63,55	3,89	1,07	63,55	6,15	8,74	10,35	18,74	10,35	1015,4	2400,00	283,0	8,07
17/10/2019	10,79	61,05	3,31	0,96	61,05	7,29	7,52	10,07	18,74	10,07	1015,4	2400,00	305,5	8,16
18/10/2019	10,60	60,95	3,44	0,87	60,95	6,23	4,82	9,78	18,81	9,78	1015,4	2400,00	309,5	3,26
19/10/2019	11,97	61,11	4,02	1,50	61,11	5,30	11,66	10,26	18,81	10,26	1015,4	2400,00	309,5	1,26
20/10/2019	11,65	57,90	3,66	1,04	57,90	6,30	4,82	9,78	18,81	9,78	1015,4	2400,00	309,5	1,11
21/10/2019	10,83	60,90	3,66	1,04	60,90	5,30	4,82	9,78	18,81	9,78	1015,4	2400,00	309,5	0,55
22/10/2019	12,58	60,90	4,17	1,01	60,90	3,72	3,89	10,16	16,97	10,16	1020,5	23,56,30	401,6	0,27
23/10/2019	11,89	61,05	4,17	1,13	61,05	4,17	3,89	10,16	16,97	10,16	1020,5	23,56,30	401,6	1,11
24/10/2019	11,89	61,05	1,61	0,87	61,05	6,23	4,82	9,78	18,81	9,78	1015,4	2400,00	309,5	1,26
25/10/2019	Arêté	Arêté	Arêté	Arêté	Arêté	Arêté	Arêté	Arêté	Arêté	Arêté	Arêté	Arêté	Arêté	Arêté
26/10/2019	Arêté	Arêté	Arêté	Arêté	Arêté	Arêté	Arêté	Arêté	Arêté	Arêté	Arêté	Arêté	Arêté	Arêté
27/10/2019	Arêté	Arêté	Arêté	Arêté	Arêté	Arêté	Arêté	Arêté	Arêté	Arêté	Arêté	Arêté	Arêté	Arêté
28/10/2019	Arêté	Arêté	Arêté	Arêté	Arêté	Arêté	Arêté	Arêté	Arêté	Arêté	Arêté	Arêté	Arêté	Arêté
29/10/2019	Arêté	Arêté	Arêté	Arêté	Arêté	Arêté	Arêté	Arêté	Arêté	Arêté	Arêté	Arêté	Arêté	Arêté
30/10/2019	11,17	58,86	2,58	0,75	58,86	4,60	3,58	10,14	18,16	10,14	981,7	24,400,00	178,0	0,9
31/10/2019	10,81	58,86	2,42	0,83	58,86	4,76	3,29	10,22	18,08	10,22	988,9	22,355,00	246,1	0,29
Max.	14,06	64,31	4,17	1,06	64,31	8,29	11,66	13,22	19,08	13,22	1030,2	401,6	240,0	8,16
Dep. VLE Jour	9,75	1,61	0	0	1,61	1,27	0,26	9,34	11,91	9,34	981,7	0	0,0	0,00
Nb Jour Jars	0	0	0	0	0	0	0	0	0	0	0	0	0	0
Dep. VLE Max	600,00	0	0	0	0	0	0	0	0	0	0	0	0	0
Dep. Scaill Min.														
Dep. VLE 1/2h	0	0	0	0	5	2	0	0	0	0	0	0	0	0
Moy. Mensuelle	11,27	3,42	0	1,03	62,48	6,11	6,19	10,03	18,17	10,03	1014,3	26,175,10	8497,5	244,0
% données HG	0,00	0,00	0,00	0,00	0,00	0,00	0,00	0,00	0,00	0,00	0,0	0,0	0,0	0,8
% données HG Annuel	0,00	0,00	0,00	0,00	0,00	0,00	0,00	0,00	0,00	0,00	0,0	0,0	0,0	0,0

Contrôle	CO	NOX	POUSSIERE	SO2	Visesse	O2	TS L1	Marché-Poul L1	Tonnage OM L1	Tonnage DASRL L1	Rabot Jour L1
01:00	0	0	0	0	0	0	0	0	0	0	0
04:00	13,30	1	1	1	02,00	1	08,30	00,30	04,30	0	33,00
08:00	08,00	0	0	0	08,00	0	08,00	08,00	07,30	0	09,30

* Le 10/10/2019, dépassement de 5 moyennes 30' en NOx à 250, 90mg/Nm3, 312,08mg/Nm3, 362,40mg/Nm3, 340,10mg/Nm3 suite à un dysfonctionnement du brûleur DENOX.

* Le 21/10/2019, dépassement de 2 moyennes 30' en poussières (pour une limite à 30):

- à 83,99 mg/Nm3 consécutive à une mise en sécurité chaudière pendant le test ballon
- à 53,52mg/Nm3 suite à la perte de la garde du extracteur mâcheferes.

Rapport DREAL Mensuel Ligne 1

Novembre 2019

Mesure IC 95 Mensuel L1														
CO	CO2	HCL	NOX	POUSSIERE	SO2	NH3	Vitesse	O2	TZS L1	Marché (out.L)	Tonnage OML1	Tonnage DASRL1	Rabot Jour L1	
Unités mg/Nm3	mg/Nm3	mg/Nm3	mg/Nm3	mg/Nm3	10	50	m/s	%	degC	hh:mm:ss	Tonnage	Tonnage		
VLE Max	COT	10	10	80	150	200	10	15	degC	h				
VLE 1/2h	100	20	60	160	30	200	20			h				
02/11/2019	10.39	2.51	0.99	57.01	3.88	3.27	0.03	19.06	9.77	1028.3	24000.00	310.0	0.0	0.00
03/11/2019	10.56	2.30	1.04	56.97	3.70	3.41	0.08	18.62	9.52	1013.6	24000.00	370.4	0.0	0.00
04/11/2019	10.68	2.33	1.04	56.99	3.61	3.61	0.13	18.57	9.58	1013.6	24000.00	381.0	0.0	0.00
05/11/2019	11.82	2.47	1.23	56.34	2.63	2.96	0.12	17.47	9.99	992.8	24000.00	295.7	9.2	3.11
06/11/2019	10.10	2.28	0.95	56.97	2.55	3.80	0.04	17.90	9.07	1028.8	24000.00	287.1	10.8	3.76
07/11/2019	9.12	2.04	1.13	57.20	2.87	4.40	0.06	17.45	9.06	1019.6	24000.00	332.7	11.6	3.49
08/11/2019	9.65	2.28	0.98	57.24	2.77	3.26	0.11	18.07	9.55	1028.3	24000.00	359.3	5.7	1.59
09/11/2019	10.08	2.34	0.90	61.08	3.48	6.18	0.02	18.53	9.83	1035.8	24000.00	390.3	6.5	1.67
10/11/2019	10.10	2.41	0.84	61.06	3.06	3.61	0.03	18.53	9.83	1035.8	24000.00	402.1	0.0	0.00
11/11/2019	9.55	2.40	0.80	60.67	3.32	3.41	0.06	18.22	9.25	1024.9	24000.00	358.8	5.5	1.53
12/11/2019	9.35	2.46	0.81	60.99	2.18	3.44	0.02	17.76	9.10	1037.2	24000.00	325.4	16.6	5.10
13/11/2019	9.38	2.47	0.82	61.12	2.50	3.70	0.04	18.16	9.49	1037.2	24000.00	287.5	18.2	6.33
14/11/2019	9.65	2.49	0.88	60.98	2.13	3.97	0.09	18.00	9.51	1025.7	24000.00	268.6	23.9	8.45
15/11/2019	10.01	2.56	0.85	61.20	1.97	3.52	0.07	17.80	9.70	1025.7	24000.00	286.2	2.7	0.94
16/11/2019	10.44	2.61	0.81	61.04	2.21	4.14	0.03	18.06	9.86	1028.4	24000.00	300.3	0.3	0.08
17/11/2019	9.37	2.38	0.97	60.77	2.03	4.25	0.12	18.01	9.73	1030.1	24000.00	343.7	2.1	0.61
18/11/2019	9.87	2.42	1.08	56.62	1.66	3.58	0.09	17.73	9.85	1030.6	24000.00	326.8	0.0	0.00
19/11/2019	9.97	2.44	0.92	56.60	1.65	3.72	0.05	17.66	9.61	1032.0	24000.00	343.7	2.1	0.61
20/11/2019	10.58	2.58	0.80	56.97	1.69	3.82	0.04	17.01	10.00	1032.0	24000.00	352.8	3.0	0.85
21/11/2019	10.40	2.51	0.81	57.30	2.40	4.25	0.08	17.83	9.59	1030.6	24000.00	334.9	7.6	2.27
22/11/2019	9.86	2.26	1.03	56.86	2.42	3.98	0.06	17.85	9.59	1036.0	24000.00	434.9	6.0	1.38
23/11/2019	10.16	2.22	1.04	56.74	1.94	3.48	0.06	17.68	9.69	1036.0	24000.00	356.2	0.0	0.00
24/11/2019	9.84	2.26	0.97	56.56	1.63	3.79	0.10	17.70	9.83	1036.0	24000.00	409.6	0.0	0.00
25/11/2019	10.79	2.26	0.95	56.62	1.83	3.67	0.03	17.41	9.95	1031.7	24000.00	324.6	0.0	0.00
26/11/2019	9.40	1.98	0.95	56.70	1.95	3.50	0.03	17.60	9.31	1031.0	24000.00	327.9	5.8	1.77
27/11/2019	9.86	1.83	0.94	56.89	1.75	3.61	0.01	17.04	9.56	1031.0	24000.00	325.6	1.3	0.40
28/11/2019	9.73	1.99	0.97	57.09	2.59	4.33	0.08	17.68	9.30	1036.1	24000.00	329.6	6.9	2.09
29/11/2019	10.44	2.01	1.35	57.03	2.18	9.56	0.06	16.99	9.53	1042.6	24000.00	417.1	4.9	1.17
30/11/2019	9.70	1.84	1.21	56.79	1.43	8.72	0.05	16.21	9.62	1050.7	24000.00	398.7	2.2	0.55
Max.	11.82	2.61	1.35	61.20	3.88	9.56	0.13	19.06	10.00	1050.7	24000.00	434.9	21.9	8.45
Dep. VLE jour	9.12	1.83	0.80	56.34	1.43	2.96	0.01	16.21	9.07	999.0	24000.00	268.6	0.0	0.00
Nb Jour Inva.	0	0	0	0	0	0	0	0	0	0	0	0	0	0
Nb Jour Inva.	0	0	0	0	0	0	0	0	0	0	0	0	0	0
Dep. VLE Max	00:00	00:00	00:00	00:00	00:00	00:00	00:00	00:00	00:00	00:00	00:00	00:00	00:00	00:00
Dep. VLE 1/2h	1	0	0	0	0	0	0	0	0	0	0	0	0	0
Moy. Mensuelle	10.10	2.31	0.96	58.26	2.35	4.04	0.06	17.80	9.62	1028.4	29122:16:50	1028.0	165.0	0.00
% données HG	0.00	0.00	0.00	0.00	0.00	0.00	0.00	0.00	0.00	0.00	0.00	0.00	0.00	0.00
% données HG	0.00	0.00	0.00	0.00	0.00	0.00	0.00	0.00	0.00	0.00	0.00	0.00	0.00	0.00
Annuel														

* Le 29/11/2019, dépassement d'une moyenne 30' en CO à 149.5 mg/Nm3 (pour une limite à 100) suite à une mise en sécurité du TF.

Rapport DREAL Mensuel Ligne 1

Rapport Mensuel														Decembre 2019	
Mesure IC 95 Mensuel LI															
CO	COT	HCL	NOX	POUSSIERE	SO2	NH3	Velocite	O2	T2S L1	Marche/ont.L1	Tonnage OM.L1	Tonnage DASRI.L1	Rabo Jour L1		
Unité mg/Nm3	mg/Nm3	mg/Nm3	mg/Nm3	mg/Nm3	mg/Nm3	mg/Nm3	m/s	%	degrC	hh:mm:ss	Tonne	Tonne			
VLE Jour	50	10	10	80	10	50	10	15							
VLE Max	100	20	60	160	150	200	20								
Seuil Vbs	100	20	60	160	150	200	20								
VLE 1/2h	100	20	60	160	150	200	20								
01/12/2019	8.45	1.50	1.09	56.80	1.30	7.16	0.08	15.98	9.55	1051.6	24.000.00	396.6	0.0		
02/12/2019	9.69	1.83	1.02	56.98	1.95	6.70	0.02	16.62	9.64	1033.4	23.945.30	320.0	3.6		
03/12/2019	8.91	1.14	0.88	57.35	2.43	4.09	0.07	18.18	9.71	1037.4	24.000.00	355.1	8.4		
04/12/2019	8.99	2.10	0.88	58.43	1.88	7.81	0.05	17.90	9.73	1036.0	24.000.00	327.2	3.7		
05/12/2019	9.31	2.08	0.81	58.02	1.85	8.16	0.04	17.35	9.66	1039.4	24.000.00	377.1	1.34		
06/12/2019	9.32	2.02	0.97	58.44	1.73	12.12	0.06	17.00	9.58	1045.4	24.000.00	367.2	3.0		
07/12/2019	8.97	1.85	1.24	58.59	1.61	6.18	0.02	17.04	9.58	1041.8	24.000.00	295.7	0.4		
08/12/2019	9.16	1.82	1.02	58.56	5.51	8.43	0.03	18.58	9.50	1038.0	24.000.00	397.6	0.0		
09/12/2019	9.16	1.81	1.09	58.96	5.32	7.84	0.06	18.55	9.58	1020.6	23.380.00	366.7	0.1		
10/12/2019	9.24	1.95	2.49	58.69	3.36	4.76	0.07	18.43	9.70	1013.1	24.000.00	320.8	7.0		
11/12/2019	8.98	1.89	1.16	58.49	3.60	6.04	0.11	18.69	9.59	1031.1	24.000.00	402.4	4.9		
12/12/2019	8.88	1.90	1.02	58.02	2.99	5.21	0.06	18.17	9.45	1035.2	24.000.00	350.8	12.4		
13/12/2019	9.12	1.83	1.14	58.63	3.32	5.72	0.04	18.55	9.55	1021.8	24.000.00	447.7	3.24		
14/12/2019	9.11	1.84	0.99	63.24	1.11	4.05	0.06	18.31	9.64	1023.8	24.000.00	421.7	2.8		
15/12/2019	8.94	1.80	0.99	65.15	1.90	5.92	0.02	18.04	9.68	1028.8	24.000.00	345.2	0.5		
16/12/2019	9.36	1.90	1.04	65.43	2.19	8.34	0.05	17.90	9.58	1038.1	24.000.00	305.6	4.2		
17/12/2019	8.78	1.72	1.26	65.31	1.72	12.34	0.03	17.49	9.60	1040.8	24.000.00	245.5	12.7		
18/12/2019	9.39	1.85	1.03	65.60	1.82	10.48	0.06	17.13	9.61	1042.2	24.000.00	327.7	5.8		
19/12/2019	8.71	1.71	1.23	65.72	2.22	8.05	0.07	17.75	9.59	1031.8	24.000.00	365.6	10.4		
20/12/2019	8.89	1.82	1.06	65.49	1.95	4.76	0.06	17.38	9.57	1031.3	24.000.00	370.2	3.70		
21/12/2019	9.44	1.90	0.88	65.36	1.74	4.34	0.04	17.22	9.39	1035.1	24.000.00	423.5	0.0		
22/12/2019	8.75	1.93	0.90	65.24	1.58	5.94	0.20	16.92	9.53	1035.1	24.000.00	373.2	0.0		
23/12/2019	11.96	2.20	0.93	65.63	2.17	6.45	0.05	17.35	10.06	1022.1	24.000.00	264.9	7.0		
24/12/2019	8.69	2.07	0.93	65.26	1.77	6.53	0.03	17.67	9.71	1035.1	24.000.00	423.5	0.57		
25/12/2019	8.84	2.04	0.91	65.31	1.73	9.21	0.03	17.53	9.74	1045.6	24.000.00	423.5	7.0		
26/12/2019	9.07	2.18	0.85	65.72	1.65	8.36	0.04	17.28	9.76	1045.4	24.000.00	360.8	0.0		
27/12/2019	8.84	2.02	0.88	65.01	1.65	8.36	0.15	17.44	9.79	1043.4	24.000.00	392.8	0.26		
28/12/2019	9.13	2.13	0.85	64.90	1.39	5.41	0.10	16.95	9.84	1044.6	24.000.00	312.7	0.0		
29/12/2019	9.13	2.26	0.85	65.28	1.26	8.18	0.03	16.79	9.72	1044.2	24.000.00	211.8	0.0		
30/12/2019	9.43	2.41	0.89	65.52	1.27	11.72	0.04	16.51	9.81	1042.7	24.000.00	207.4	0.0		
31/12/2019	9.41	2.24	0.86	65.10	1.36	14.00	0.02	16.64	9.37	1047.0	23.490.00	213.9	0.0		
Max.	11.96	2.41	2.49	65.72	5.51	14.00	0.28	18.69	10.06	1053.6		447.7	14.5		
Dep. VLE Jour	8.45	1.50	0.81	56.80	1.26	4.05	0.02	15.98	9.37	1013.1		207.4	0.0		
Nb Jour Jars.	0	0	0	0	0	0	0	0	0	0	0	0	0		
Dep. VLE Max	0	0	0	0	0	0	0	0	0	0	0	0	0		
Dep. Seuil Vbs.	0	0	0	0	0	0	0	0	0	0	0	0	0		
Dep. VLE 1/2h	0	0	0	0	0	0	0	0	0	0	0	0	0		
Moy. Mensuelle	9.18	1.95	1.05	62.40	2.24	7.54	0.06	17.53	9.64	1035.6	301 23.341.40	1053.13	121.5		
% donneses HG	0.00	0.00	0.00	0.00	0.00	0.00	0.00	0.00	0.00	0.0	0	0.0	0.0		
% donneses HG	0.00	0.00	0.00	0.00	0.00	0.00	0.00	0.00	0.00	0.0	0	0.0	0.0		
Annuel															

Contrat réglementaire LI - 2019 HCL													
Depassement >4H													
Dep. VLE	01:00	02:00	03:00	04:00	05:00	06:00	07:00	08:00	09:00	10:00	11:00	12:00	13:00
Nb Jour Jars.	1	1	1	1	1	1	1	1	1	1	1	1	1
Nb Jour Jars.	1	1	1	1	1	1	1	1	1	1	1	1	1
Indice Cons >10h	0	0	0	0	0	0	0	0	0	0	0	0	0
Indisponibilité	08:00	08:00	08:00	08:00	08:00	08:00	08:00	08:00	08:00	08:00	08:00	08:00	08:00
Total	0	0	0	0	0	0	0	0	0	0	0	0	0
Global	0	0	0	0	0	0	0	0	0	0	0	0	0

* Le 09/12/2019, deux dépassements d'une moyenne 30' en NOx à 257.98mg/Nm3 (pour une limite à 160) et en poussières à 32.29mg/Nm3 (pour une limite à 30) suite à une mise en sécurité du TF.

The first part of the document discusses the importance of maintaining accurate records of all transactions. It emphasizes that every entry, no matter how small, should be recorded to ensure the integrity of the financial statements. This includes not only sales and purchases but also expenses, income, and transfers.

The second part of the document provides a detailed explanation of the accounting cycle. It outlines the ten steps involved in the process, from identifying the accounting entity to preparing financial statements. Each step is described in detail, with examples provided to illustrate the concepts.

The third part of the document discusses the various types of accounts used in accounting. It explains the difference between assets, liabilities, and equity accounts, and how they are classified. It also discusses the importance of understanding the normal balances for each type of account.

The fourth part of the document discusses the process of adjusting entries. It explains why adjustments are necessary and how they are recorded. It provides examples of common adjusting entries, such as depreciation, amortization, and accruals.

The fifth part of the document discusses the preparation of financial statements. It explains how the adjusted trial balance is used to prepare the income statement, balance sheet, and statement of owner's equity. It also discusses the importance of presenting the financial statements in a clear and concise manner.

The sixth part of the document discusses the closing process. It explains how the temporary accounts (revenues, expenses, and dividends) are closed to the permanent accounts (retained earnings). It provides a step-by-step guide to the closing process.

The seventh part of the document discusses the importance of internal controls. It explains how internal controls help to prevent errors and fraud, and how they can be designed to protect the organization's assets.

The eighth part of the document discusses the role of the accountant. It explains the various responsibilities of an accountant, including recording transactions, preparing financial statements, and providing financial advice to management.

The ninth part of the document discusses the importance of ethics in accounting. It explains how accountants should adhere to a code of ethics and how they should handle conflicts of interest.

The tenth part of the document discusses the future of accounting. It discusses the impact of technology on the profession and the need for accountants to stay current in their knowledge and skills.

Date	Du 26/12/2018 au 23/01/2019	Du 23/01/2019 au 19/02/2019	Du 19/02/2019 au 19/03/2019	Du 16/04/2019 au 14/05/2019	Du 16/04/2019 au 11/06/2019	Du 09/07/2019 au 09/07/2019	Du 09/07/2019 au 06/08/2019	Du 06/08/2019 au 03/09/2019	Du 03/09/2019 au 01/10/2019	Du 01/10/2019 au 29/10/2019	Du 29/10/2019 au 26/11/2019	Du 26/11/2019 au 23/12/2019
Prélèvement	AMESA	AMESA	AMESA	AMESA	AMESA	AMESA	AMESA	AMESA	AMESA	AMESA	AMESA	AMESA
Analyse	Dioxlab	Dioxlab	Dioxlab	Dioxlab	Dioxlab	Dioxlab	Dioxlab	Dioxlab	Dioxlab	Dioxlab	Dioxlab	Dioxlab
Données générales												
Durée de la période	3,975	3,877	3,999	4,000	3,997	4,002	* AT L1	4,006	3,997	3,993	4,001	3,850
Durée de prélèvement	667,53	625,37	666,35	661,82	667,15	430,82	0,00	430,02	638,55	560,38	664,88	622,87
Durée de fonctionnement de l'installation	667,8	651,3	671,1	665,1	667,4	431,7	0,0	450,6	639,5	569,6	667,9	646,5
Indisponibilité du système de prélèvement	0,0%	4,0%	0,4%	0,5%	0,0%	0,2%	#DIV/0!	4,6%	0,1%	1,6%	0,5%	3,7%
Indisponibilité du système de prélèvement depuis début d'année	0,0%	2,0%	1,4%	1,2%	1,0%	0,9%	0,9%	1,3%	1,1%	1,1%	1,0%	1,3%
Volume des fumées rejetées sur la période de prélèvement	50 466 506	46 760 668	53 597 283	52 442 977	52 972 532	33 208 057	0	36 209 014	51 157 669	42 174 504	50 485 529	45 821 867
Débit horaire moyen des fumées rejetées sur la période de prélèvement	75577	71801	79867	78848	79373	76924	#DIV/0!	80351	79998	74049	75585	70873
Volume prélevé	434,882	404,188	461,934	449,909	457,771	285,117	357,353	307,207	437,198	365,013	435,503	394,487
Débit prélèvement sur sec	0,65	0,65	0,69	0,68	0,69	0,66	#DIV/0!	0,71	0,68	0,65	0,66	0,63
O ₂	10,30	10,30	10,10	10,10	10,10	10,40	10,40	10,90	10,30	10,00	9,70	9,60
H ₂ O	199,00	201,00	207,00	203,00	209,00	212,00	0,00	190,00	202,00	207,00	207,00	206,00
Ratio volume rejeté/prélevé	116046,44	115690,39	116028,01	116563,52	115718,41	116471,68	0,00	117965,20	117012,59	115976,03	115924,64	116155,58
Ratio volume/durée prélèvement	0,65	0,65	0,69	0,68	0,69	0,66	#DIV/0!	0,71	0,68	0,65	0,66	0,63
Teneur en PCDD/F @11% O₂ sur gaz sec												
Teneur en PCDD/F sur brut	0,007	0,434	0,529	0,476	0,570	0,576	#DIV/0!	0,120	0,079	0,328	0,082	0,083
Teneur en PCDD/F en I-TEQ	0,00007	0,035	0,044	0,041	0,047	0,047	#DIV/0!	0,005	0,004	0,021	0,004	0,005
Flux de PCDD/F												
Flux de PCDD/F en I-TEQ	0,003	1,649	2,346	2,134	2,495	1,563	0,000	0,188	0,214	0,901	0,221	0,225
Flux de PCDD/F en I-TEQ cumulé	0,003	1,652	3,998	6,132	8,627	10,190	10,190	10,378	10,592	11,808	12,029	12,253

COMMENTAIRE :

* AT L1: Arrêt technique de la L1 (du 01/06 au 12/07) pendant toute la période de mesure

3.2. Ligne EMERAUDE N°2

- 3.2.1. Mesure en continu des flux de polluants**
- 3.2.2. Mesure en continu des concentrations en polluants**
- 3.2.3. Mesure en semi continu des dioxines et furanes**



Rapport DREAL Flux Mensuel Ligne 2

Rapport Flux Mensuel													Janvier 2019	
FLUX Ligne 2														
Unité	CO	COT	HCL	NOX	POUSSIÈRE	SO2	NH3	Marché Four L2						
VLE Jour	Kg	Kg	Kg	Kg	Kg	Kg	Kg	hh:mm:ss	hh:mm:ss					
	57.61	19.2	19.2	19.2	153.6	19.2	96	19.2	19.2					
01/01/2019	13.304	2.002	1.423	142.592	10.977	2.419	0.161	23:58:10						
02/01/2019	13.450	1.824	1.876	135.383	10.325	4.504	0.010	24:00:00						
03/01/2019	14.386	1.958	1.513	135.388	10.343	2.352	0.060	24:00:00						
04/01/2019	14.622	1.522	1.523	133.358	9.693	3.538	0.000	24:00:00						
05/01/2019	17.766	2.168	1.094	130.855	10.727	2.463	0.897	23:52:50						
06/01/2019	12.739	1.758	1.330	131.980	11.103	3.490	0.029	24:00:00						
07/01/2019	12.861	1.678	1.233	103.701	10.789	3.209	0.079	20:54:10						
08/01/2019	15.725	2.057	1.592	132.443	16.138	3.162	0.016	24:00:00						
09/01/2019	14.759	1.853	1.279	132.074	11.926	1.324	0.057	24:00:00						
10/01/2019	15.192	1.819	1.618	128.483	14.930	2.983	0.003	24:00:00						
11/01/2019	15.845	1.845	1.663	127.074	16.971	2.408	0.134	24:00:00						
12/01/2019	14.809	1.853	1.538	131.593	11.920	2.302	0.003	24:00:00						
13/01/2019	14.687	1.852	1.265	133.604	10.213	3.518	0.033	24:00:00						
14/01/2019	13.234	1.773	2.458	128.806	10.883	4.490	0.118	24:00:00						
15/01/2019	13.307	1.623	1.586	113.739	14.141	2.916	0.291	21:04:00						
16/01/2019	15.110	1.808	1.524	134.046	13.558	1.812	0.064	24:00:00						
17/01/2019	14.302	1.684	1.554	131.025	12.616	2.720	0.123	24:00:00						
18/01/2019	14.325	1.642	1.430	132.834	13.124	2.169	0.177	24:00:00						
19/01/2019	17.059	1.774	1.391	129.260	17.930	0.982	0.033	24:00:00						
20/01/2019	15.205	1.509	1.341	130.756	15.942	1.485	0.179	24:00:00						
21/01/2019	14.364	1.606	1.300	135.024	11.578	1.382	0.059	24:00:00						
22/01/2019	14.738	1.526	1.455	133.938	14.280	1.414	0.193	24:00:00						
23/01/2019	14.491	1.319	1.387	132.785	13.146	2.041	0.004	24:00:00						
24/01/2019	13.245	1.401	1.567	132.606	12.808	1.784	0.058	24:00:00						
25/01/2019	13.826	1.247	1.942	125.401	13.273	2.973	0.041	24:00:00						
26/01/2019	10.671	1.427	1.770	132.902	9.478	2.259	0.034	24:00:00						
27/01/2019	12.248	1.623	1.631	134.249	11.311	2.523	0.024	24:00:00						
28/01/2019	11.586	1.472	1.934	135.439	8.277	2.802	0.097	24:00:00						
29/01/2019	12.701	1.290	1.290	134.120	9.713	2.614	0.129	24:00:00						
30/01/2019	12.556	1.396	1.624	130.649	9.066	4.810	0.012	24:00:00						
31/01/2019	13.986	1.411	1.515	133.775	9.783	5.598	0.151	24:00:00						
Min	10.671	1.247	1.094	103.701	8.277	0.982	0.000							
Max	17.766	2.168	2.458	142.592	17.930	5.598	0.897							
Cumul	437.099	52.072	47.594	4059.882	376.962	84.446	3.269							
VLE Flux Jour	0	0	0	0	0	0	0							
											30j 17:49:10			



Rapport DREAL Flux Mensuel Ligne 2

Rapport Flux Mensuel													Février 2019	
FLUX Ligne 2														
CO	COT	HCL	NOx	POUSSIÈRE	SO2	NH3	MarcheFourL2							
Unité Kg	Kg	Kg	Kg	Kg	Kg	Kg	hh:mm:ss							
VLE Jour	57.61	19.2	19.2	153.6	19.2	96	19.2							
01/02/2019	13.554	1.449	2.031	137.462	11.877	17.440	0.018						24:00:00	
02/02/2019	14.142	1.573	1.748	133.590	16.425	8.529	0.027						24:00:00	
03/02/2019	13.394	1.615	1.551	140.333	13.657	11.973	0.061						24:00:00	
04/02/2019	13.084	1.621	1.477	138.916	10.662	8.969	0.075						24:00:00	
05/02/2019	13.055	1.625	1.828	138.897	9.687	12.530	0.030						24:00:00	
06/02/2019	13.118	1.689	2.105	135.995	12.445	9.436	0.035						24:00:00	
07/02/2019	12.535	1.811	2.355	136.339	9.291	25.511	0.006						24:00:00	
08/02/2019	12.652	1.925	2.059	132.997	10.408	26.960	0.102						24:00:00	
09/02/2019	13.087	1.882	1.928	131.823	11.497	20.461	0.064						24:00:00	
10/02/2019	11.918	1.855	1.602	131.823	8.207	34.954	0.067						24:00:00	
11/02/2019	12.832	1.736	1.779	128.192	11.816	28.284	0.140						24:00:00	
12/02/2019	12.392	1.703	1.758	133.250	7.752	9.243	0.052						24:00:00	
13/02/2019	12.538	1.618	1.367	133.815	8.061	9.371	1.861						24:00:00	
14/02/2019	12.132	1.577	1.769	134.861	8.339	8.202	0.016						24:00:00	
15/02/2019	11.612	1.638	1.956	135.902	7.696	7.256	0.121						24:00:00	
16/02/2019	13.049	1.934	1.791	132.956	11.201	10.429	0.016						24:00:00	
17/02/2019	11.691	1.859	1.839	132.372	10.599	8.742	0.059						24:00:00	
18/02/2019	12.625	1.829	2.041	133.254	11.276	8.440	0.201						24:00:00	
19/02/2019	12.861	1.991	2.048	133.410	11.145	9.059	0.075						24:00:00	
20/02/2019	12.961	1.761	2.034	129.797	9.890	9.567	0.141						24:00:00	
21/02/2019	12.213	1.361	2.223	131.349	10.533	7.558	0.193						24:00:00	
22/02/2019	12.998	0.957	2.175	132.234	11.492	8.771	0.156						24:00:00	
23/02/2019	12.557	1.094	2.097	132.810	11.187	7.903	0.175						24:00:00	
24/02/2019	11.991	1.414	1.928	133.790	9.623	9.020	0.073						24:00:00	
25/02/2019	12.371	1.397	2.309	131.131	10.990	11.602	0.124						24:00:00	
26/02/2019	12.511	1.654	3.118	130.779	13.264	19.798	0.157						24:00:00	
27/02/2019	13.063	1.986	2.182	130.136	10.481	11.466	0.105						24:00:00	
28/02/2019	12.744	1.802	2.261	132.126	11.394	7.962	0.117						24:00:00	
Min	11.612	0.957	1.367	128.192	7.696	7.256	0.006							
Max	14.142	1.991	3.118	140.333	16.425	34.954	1.861							
Cumul	355.680	46.356	55.359	3740.339	300.895	369.436	4.267						25j 00:00:00	
VLE Flux Jour	0	0	0	0	0	0	0						0	



Rapport DREAL Flux Mensuel Ligne 2

Rapport Flux Mensuel											Mars 2019	
FLUX Ligne 2												
Unité	CO	COF	HCL	NOX	POUSSIERE	SO2	NH3	MarcheFourL2				
VLE_Jour	Kg	Kg	Kg	Kg	Kg	Kg	Kg	hh:mm:ss				
	57,61	19,2	153,6	19,2	96	19,2	19,2					
01/03/2019	13.328	1.762	129.724	2.165	13.252	6.805	0.063	24:00:00				
02/03/2019	13.088	1.768	131.058	2.051	13.168	4.607	0.172	24:00:00				
03/03/2019	12.379	1.871	130.132	2.118	11.688	6.170	0.044	24:00:00				
04/03/2019	13.153	1.871	130.090	2.021	14.153	8.432	0.092	24:00:00				
05/03/2019	12.655	1.846	124.892	2.003	11.078	9.816	0.010	24:00:00				
06/03/2019	13.638	1.861	130.478	2.450	12.234	13.350	0.035	24:00:00				
07/03/2019	12.356	1.854	131.796	2.000	12.521	10.428	0.091	24:00:00				
08/03/2019	12.726	1.739	131.824	2.119	11.697	9.242	0.039	24:00:00				
09/03/2019	13.641	1.675	131.039	2.151	13.787	8.631	0.133	24:00:00				
10/03/2019	16.446	1.860	132.769	1.928	11.990	13.492	0.123	24:00:00				
11/03/2019	13.383	1.441	128.235	1.876	12.470	9.787	0.095	24:00:00				
12/03/2019	13.929	1.220	132.328	2.297	14.820	9.194	0.020	24:00:00				
13/03/2019	15.821	0.946	130.374	2.369	12.016	24.192	0.010	24:00:00				
14/03/2019	16.155	0.568	125.339	3.841	12.809	32.784	0.054	24:00:00				
15/03/2019	16.094	0.001	123.184	5.559	14.619	16.908	0.000	24:00:00				
16/03/2019	18.039	0.016	127.911	5.551	16.564	17.862	0.087	24:00:00				
17/03/2019	18.464	0.163	125.845	5.172	14.777	14.678	0.236	24:00:00				
18/03/2019	20.178	0.297	122.554	4.242	12.725	19.906	0.043	24:00:00				
19/03/2019	17.906	0.028	121.203	3.949	13.273	30.543	0.030	24:00:00				
20/03/2019	18.070	0.000	120.395	3.802	14.015	20.494	0.154	24:00:00				
21/03/2019	17.798	0.185	122.863	3.554	12.216	22.566	0.145	24:00:00				
22/03/2019	17.417	0.000	119.578	3.413	9.367	22.695	0.065	23:51:10				
23/03/2019	6.430	0.000	52.809	5.524	6.390	6.182	1.334	11:08:50				
24/03/2019	16.223	0.001	128.421	2.600	13.718	39.339	0.064	24:00:00				
25/03/2019	15.989	0.000	134.745	2.593	13.416	20.412	0.039	24:00:00				
26/03/2019	14.691	0.000	127.858	3.492	11.899	20.392	0.066	24:00:00				
27/03/2019	15.257	0.003	124.805	3.277	14.671	30.405	0.086	24:00:00				
28/03/2019	15.728	0.000	125.237	3.245	10.819	16.012	0.132	24:00:00				
29/03/2019	16.100	0.000	125.093	3.090	11.699	12.177	0.061	24:00:00				
30/03/2019	14.395	0.000	122.452	3.427	17.594	16.537	0.059	24:00:00				
31/03/2019	9.511	0.000	91.351	2.078	10.492	9.020	0.068	23:00:00				
Min	6.430	0.000	52.809	1.876	6.390	4.607	0.000					
Max	20.178	1.871	134.745	5.559	17.594	39.339	1.334					
Cumul	460.988	22.976	3836.382	95.957	395.937	503.058	3.650		30j 10:00:00			
VLE Flux_Jour	0	0	0	0	0	0	0					



Rapport DREAL Flux Mensuel Ligne 2

Rapport Flux Mensuel											Avril 2019	
FLUX Ligne 2												
CO	COT	HCL	NOx	POUSSIERE	SO2	NH3	MarcheFourL2					
Unité Kg	Kg	Kg	Kg	Kg	Kg	Kg	hh:mm:ss	hh:mm:ss				
VLE Jour	57,61	19,2	19,2	153,6	19,2	96	19,2					
01/04/2019	16.180	0.000	2.770	113.740	15.421	8.572	0.047	0.088	24:00:00	24:00:00		
02/04/2019	17.537	0.000	2.654	127.260	16.240	8.744	0.088	0.082	24:00:00	24:00:00		
03/04/2019	21.019	0.077	2.333	125.187	14.105	6.388	0.002	0.002	24:00:00	24:00:00		
04/04/2019	8.587	0.000	1.372	82.870	5.609	6.396	0.053	0.053	13:30:20	24:00:00		
05/04/2019	18.755	0.000	3.271	144.488	16.761	18.008	0.090	0.090	24:00:00	24:00:00		
06/04/2019	16.345	0.000	3.715	146.376	13.098	28.265	0.009	0.009	24:00:00	24:00:00		
07/04/2019	14.022	0.000	2.998	137.257	14.888	33.727	0.053	0.053	24:00:00	24:00:00		
08/04/2019	13.463	0.000	2.890	126.360	19.465	24.530	0.116	0.116	24:00:00	24:00:00		
09/04/2019	14.276	0.000	2.946	142.657	13.567	26.270	0.106	0.106	24:00:00	24:00:00		
10/04/2019	13.074	0.000	3.026	138.005	7.989	50.185	0.004	0.004	24:00:00	24:00:00		
11/04/2019	11.739	0.000	3.074	135.732	6.649	61.453	0.019	0.019	24:00:00	24:00:00		
12/04/2019	12.821	0.000	2.939	138.573	8.951	20.755	0.058	0.058	24:00:00	24:00:00		
13/04/2019	13.134	0.000	2.875	140.175	10.725	31.822	0.015	0.015	24:00:00	24:00:00		
14/04/2019	11.873	0.000	2.761	134.808	9.063	32.931	0.025	0.025	24:00:00	24:00:00		
15/04/2019	13.224	0.000	3.900	128.768	16.258	24.313	0.036	0.036	24:00:00	24:00:00		
16/04/2019	7.365	0.073	1.335	88.948	8.774	20.609	0.003	0.003	24:00:00	24:00:00		
17/04/2019	11.678	0.499	1.615	139.240	10.081	26.969	0.039	0.039	24:00:00	24:00:00		
18/04/2019	11.038	0.192	2.072	144.367	9.867	16.406	0.000	0.000	24:00:00	24:00:00		
19/04/2019	6.558	0.016	1.087	81.491	9.830	10.739	0.022	0.022	13:26:30	24:00:00		
20/04/2019	Arrêt	Arrêt	Arrêt	Arrêt	Arrêt	Arrêt	Arrêt	Arrêt	00:00:00	00:00:00		
21/04/2019	13.259	0.092	1.853	102.874	13.417	27.236	0.879	0.879	20:06:40	24:00:00		
22/04/2019	12.920	0.240	1.875	140.662	16.202	38.846	0.088	0.088	24:00:00	24:00:00		
23/04/2019	15.311	0.344	1.719	139.660	14.466	17.455	0.047	0.047	24:00:00	24:00:00		
24/04/2019	12.686	0.606	1.116	137.487	16.797	0.059	0.040	0.040	24:00:00	24:00:00		
25/04/2019	12.711	0.657	1.817	133.127	16.966	0.452	0.113	0.113	24:00:00	24:00:00		
26/04/2019	12.799	0.257	2.418	132.977	14.912	4.371	0.088	0.088	24:00:00	24:00:00		
27/04/2019	13.177	0.078	2.591	131.218	12.200	6.001	0.046	0.046	24:00:00	24:00:00		
28/04/2019	13.372	0.116	1.700	126.142	13.780	5.921	0.018	0.018	24:00:00	24:00:00		
29/04/2019	14.641	0.125	0.702	82.087	6.494	2.322	2.144	2.144	15:04:10	24:00:00		
30/04/2019	44.454	1.282	1.147	147.956	14.798	4.886	0.656	0.656	23:58:50	24:00:00		
Min	6.558	0.000	0.702	81.491	5.609	0.059	0.000	0.000				
Max	44.454	1.282	3.900	147.956	19.465	61.453	2.144	2.144				
Cumul	418.018	4.654	66.571	3690.492	367.373	564.631	4.904	4.904				
VLE Flux Jour	0	0	0	0	1	0	0	0	27j	14:06:30		

* Le 08/04/2019, dépassement de la valeur flux jour en POUSSIERE sur la ligne 2 à 19,471 Kg (pour un seuil à 19,2 Kg) pendant le contrôle réglementaire QAL2 des analyseurs, la société LECES a réalisé un dopage « volontaire » en poussière (Cf. Fiche d'incident N°19/001).



Rapport DREAL Flux Mensuel Ligne 2

Rapport Flux Mensuel													Mai 2019	
FLUX Ligne 2														
CO	COI	HCL	NOX	POUSSIÈRE	SO2	NH3	MarcheFourL2							
Unité Kg	Kg	Kg	Kg	Kg	Kg	Kg	hh:mm:ss							
VLE Jour	57,61	19,2	19,2	153,6	19,2	96	19,2						19,2	
01/05/2019	14.579	0.033	1.709	124.985	12.059	6.053	0.013						24:00:00	
02/05/2019	14.674	0.142	1.348	131.808	10.468	5.500	0.167						24:00:00	
03/05/2019	13.695	0.024	1.418	133.996	7.491	6.040	0.041						24:00:00	
04/05/2019	14.309	0.136	5.176	133.816	9.907	3.563	0.044						24:00:00	
05/05/2019	14.005	0.757	1.743	132.486	10.008	0.753	0.112						24:00:00	
06/05/2019	13.878	1.113	1.508	130.761	12.133	0.753	0.014						24:00:00	
07/05/2019	7.752	1.092	1.463	74.547	6.167	1.410	0.017						24:00:00	
08/05/2019	5.694	0.786	0.912	56.534	3.789	0.741	0.067						24:00:00	
09/05/2019	5.616	0.765	0.723	55.158	4.045	0.870	0.015						24:00:00	
10/05/2019	5.531	0.725	0.414	49.082	3.249	0.870	0.003						24:00:00	
11/05/2019	6.433	0.884	0.821	59.763	3.383	0.895	0.061						24:00:00	
12/05/2019	6.088	0.939	1.156	67.841	2.650	2.577	0.088						24:00:00	
13/05/2019	6.030	0.783	0.791	55.269	7.204	2.052	0.008						24:00:00	
14/05/2019	5.947	0.768	0.732	63.949	4.019	2.071	0.002						24:00:00	
15/05/2019	5.783	0.738	0.710	66.353	2.835	2.208	0.032						24:00:00	
16/05/2019	5.249	0.642	0.610	57.198	3.162	1.877	0.008						24:00:00	
17/05/2019	5.887	0.730	0.550	58.934	3.991	1.146	0.007						24:00:00	
18/05/2019	11.212	1.257	0.898	86.051	6.429	1.134	0.051						16:23:40	
19/05/2019	Arrêt	Arrêt	Arrêt	Arrêt	Arrêt	Arrêt	Arrêt						00:00:00	
20/05/2019	Arrêt	Arrêt	Arrêt	Arrêt	Arrêt	Arrêt	Arrêt						00:00:00	
21/05/2019	Arrêt	Arrêt	Arrêt	Arrêt	Arrêt	Arrêt	Arrêt						00:00:00	
22/05/2019	Arrêt	Arrêt	Arrêt	Arrêt	Arrêt	Arrêt	Arrêt						00:00:00	
23/05/2019	Arrêt	Arrêt	Arrêt	Arrêt	Arrêt	Arrêt	Arrêt						00:00:00	
24/05/2019	Arrêt	Arrêt	Arrêt	Arrêt	Arrêt	Arrêt	Arrêt						00:00:00	
25/05/2019	Arrêt	Arrêt	Arrêt	Arrêt	Arrêt	Arrêt	Arrêt						00:00:00	
26/05/2019	Arrêt	Arrêt	Arrêt	Arrêt	Arrêt	Arrêt	Arrêt						00:00:00	
27/05/2019	Arrêt	Arrêt	Arrêt	Arrêt	Arrêt	Arrêt	Arrêt						00:00:00	
28/05/2019	Arrêt	Arrêt	Arrêt	Arrêt	Arrêt	Arrêt	Arrêt						00:00:00	
29/05/2019	Arrêt	Arrêt	Arrêt	Arrêt	Arrêt	Arrêt	Arrêt						00:00:00	
30/05/2019	Arrêt	Arrêt	Arrêt	Arrêt	Arrêt	Arrêt	Arrêt						00:00:00	
31/05/2019	Arrêt	Arrêt	Arrêt	Arrêt	Arrêt	Arrêt	Arrêt						00:00:00	
Min	5.249	0.024	0.414	49.082	2.650	0.741	0.002						0.002	
Max	14.674	1.257	5.176	133.996	12.133	6.053	0.167						0.167	
Cumul	162.362	12.314	22.682	1538.531	112.989	40.500	0.750						0.750	
VLE Flux Jour	0	0	0	0	0	0	0						0	
												17j 16:23:40		



Rapport DREAL Flux Mensuel Ligne 2

Rapport Flux Mensuel											Juin 2019	
FLUX Ligné 2												
CO	COI	HCL	NOx	POUSSIERE	SO2	NH3	MarcheFourL2					
Unité Kg	Kg	Kg	Kg	Kg	Kg	Kg	hh	mm:ss				
VLE Jour	57.61	19.2	19.2	153.6	19.2	96	19.2					
01/06/2019	Arrêt	Arrêt	Arrêt	Arrêt	Arrêt	Arrêt	Arrêt	Arrêt	00:00:00	00:00:00		
02/06/2019	Arrêt	Arrêt	Arrêt	Arrêt	Arrêt	Arrêt	Arrêt	Arrêt	00:00:00	00:00:00		
03/06/2019	Arrêt	Arrêt	Arrêt	Arrêt	Arrêt	Arrêt	Arrêt	Arrêt	00:00:00	00:00:00		
04/06/2019	Indisponible	Indisponible	Indisponible	Indisponible	Indisponible	Indisponible	Indisponible	Indisponible	00:00:00	00:00:00		
05/06/2019	Arrêt	Arrêt	Arrêt	Arrêt	Arrêt	Arrêt	Arrêt	Arrêt	00:00:00	00:00:00		
06/06/2019	Arrêt	Arrêt	Arrêt	Arrêt	Arrêt	Arrêt	Arrêt	Arrêt	00:00:00	00:00:00		
07/06/2019	Arrêt	Arrêt	Arrêt	Arrêt	Arrêt	Arrêt	Arrêt	Arrêt	00:00:00	00:00:00		
08/06/2019	Arrêt	Arrêt	Arrêt	Arrêt	Arrêt	Arrêt	Arrêt	Arrêt	00:00:00	00:00:00		
09/06/2019	6.175	0.635	0.447	30.750	5.381	13.666	0.064	0.064	07:22:30	24:00:00		
10/06/2019	20.949	2.585	2.792	127.049	12.540	16.490	0.089	0.089	24:00:00	24:00:00		
11/06/2019	19.501	2.456	3.544	113.059	11.121	18.204	0.032	0.032	24:00:00	24:00:00		
12/06/2019	19.405	2.650	3.878	107.285	16.484	8.964	0.033	0.033	24:00:00	24:00:00		
13/06/2019	5.866	0.925	2.595	37.557	2.467	2.269	0.001	0.001	10:09:50	24:00:00		
14/06/2019	18.766	0.699	2.501	125.540	10.969	0.000	0.047	0.047	22:52:00	24:00:00		
15/06/2019	24.670	0.833	3.727	147.893	12.121	0.000	0.224	0.224	24:00:00	24:00:00		
16/06/2019	21.781	0.839	3.908	137.306	8.321	0.000	0.067	0.067	24:00:00	24:00:00		
17/06/2019	20.434	0.826	4.481	153.080	8.568	0.000	0.136	0.136	24:00:00	24:00:00		
18/06/2019	18.083	0.773	3.944	134.637	7.631	0.000	0.105	0.105	24:00:00	24:00:00		
19/06/2019	18.549	0.801	3.666	139.473	8.463	0.000	0.019	0.019	24:00:00	24:00:00		
20/06/2019	17.765	0.869	3.359	131.632	9.872	0.000	0.060	0.060	24:00:00	24:00:00		
21/06/2019	20.117	3.377	6.819	142.520	17.903	5.759	0.131	0.131	24:00:00	24:00:00		
22/06/2019	18.282	2.859	5.869	121.809	11.085	16.250	0.255	0.255	24:00:00	24:00:00		
23/06/2019	18.711	0.865	4.726	88.042	10.601	0.460	0.046	0.046	24:00:00	24:00:00		
24/06/2019	24.365	0.917	4.262	65.793	10.932	1.003	0.519	0.519	24:00:00	24:00:00		
25/06/2019	16.098	0.848	4.573	141.392	10.432	0.535	0.259	0.259	24:00:00	24:00:00		
26/06/2019	16.229	0.945	4.625	130.738	11.353	0.004	0.139	0.139	24:00:00	24:00:00		
27/06/2019	15.545	1.774	4.556	145.401	10.607	20.607	0.118	0.118	24:00:00	24:00:00		
28/06/2019	15.625	1.471	3.690	142.821	12.348	43.066	0.120	0.120	24:00:00	24:00:00		
29/06/2019	15.722	1.564	3.352	139.643	12.275	38.472	0.051	0.051	24:00:00	24:00:00		
30/06/2019	16.429	1.638	2.869	138.875	11.158	35.899	0.134	0.134	24:00:00	24:00:00		
Min	5.866	0.635	0.447	30.750	2.467	0.000	0.001	0.001				
Max	24.670	3.377	6.819	153.080	17.903	43.066	0.519	0.519				
Cumul	389.067	31.149	84.183	2642.295	232.632	221.648	2.649	2.649	20j 16:24:20			
VLE Flux Jour	0	0	0	0	0	0	0	0				

* Le 04/06/2019, coupure électrique générale EDF lors de l'arrêt technique lignes EME



Rapport DREAL Flux Mensuel Ligne 2

Rapport Flux Mensuel											Juillet 2019	
FLUX Ligne 2												
Unité	CO	COT	HCL	NOx	POUSSIERE	SO2	NH3	MarcheFourL2				
VLE Jour	Kg	Kg	Kg	Kg	Kg	Kg	Kg	hh:mm:ss	hh:mm:ss			
	57.61	19.2	19.2	153.6	19.2	96	19.2					
01/07/2019	15.963	1.657	2.813	139.489	10.721	40.295	0.036		24:00:00			
02/07/2019	15.784	1.684	4.049	131.424	12.781	43.500	0.106		24:00:00			
03/07/2019	15.261	1.644	3.966	132.722	14.405	54.426	0.155		24:00:00			
04/07/2019	15.219	1.641	4.413	138.528	13.933	44.736	0.012		24:00:00			
05/07/2019	15.118	1.589	4.217	151.326	16.626	42.963	0.097		24:00:00			
06/07/2019	18.022	1.684	4.085	153.756	16.824	48.287	0.080		24:00:00			
07/07/2019	15.525	1.704	3.688	141.884	15.196	37.635	0.046		24:00:00			
08/07/2019	15.200	1.694	3.680	145.252	12.191	31.961	0.079		24:00:00			
09/07/2019	14.559	1.695	3.544	143.217	12.627	11.260	0.081		24:00:00			
10/07/2019	13.833	1.649	3.674	140.128	12.682	10.399	0.079		24:00:00			
11/07/2019	13.884	1.695	3.092	139.831	13.120	9.677	0.075		24:00:00			
12/07/2019	13.853	1.673	2.488	81.119	14.369	11.292	1.869		24:00:00			
13/07/2019	13.827	1.741	4.780	131.408	12.348	40.373	0.056		24:00:00			
14/07/2019	17.739	1.881	4.492	91.672	11.361	44.298	0.045		24:00:00			
15/07/2019	13.079	1.771	4.466	95.876	11.401	38.347	0.054		24:00:00			
16/07/2019	13.203	1.690	4.617	74.134	11.589	20.278	2.891		24:00:00			
17/07/2019	13.655	1.617	2.375	55.980	8.154	19.556	0.644		24:00:00			
18/07/2019	14.682	1.657	3.186	102.356	14.148	27.727	0.052		24:00:00			
19/07/2019	15.722	1.709	4.413	127.519	15.802	20.270	0.214		24:00:00			
20/07/2019	14.310	1.727	3.331	144.264	9.513	31.969	0.203		24:00:00			
21/07/2019	17.534	1.766	4.022	131.810	14.980	34.694	0.048		24:00:00			
22/07/2019	18.044	1.752	4.008	136.966	11.571	32.867	0.157		24:00:00			
23/07/2019	14.568	1.549	3.968	141.842	10.335	31.350	0.061		24:00:00			
24/07/2019	14.558	1.482	3.776	139.046	10.021	39.723	0.097		24:00:00			
25/07/2019	13.005	1.436	3.844	130.462	9.747	37.303	0.075		24:00:00			
26/07/2019	13.556	1.608	3.066	144.227	7.802	49.553	0.043		24:00:00			
27/07/2019	15.095	1.780	4.525	148.020	8.468	38.686	0.149		24:00:00			
28/07/2019	14.699	1.751	2.930	146.463	13.132	40.606	0.011		24:00:00			
29/07/2019	14.996	1.691	5.043	131.804	16.812	34.963	0.095		24:00:00			
30/07/2019	15.544	1.772	3.962	128.322	13.261	33.079	0.103		24:00:00			
31/07/2019	13.514	1.588	3.617	113.780	17.312	34.727	0.041		21:04:00			
Min	13.005	1.436	2.375	55.980	7.802	9.677	0.011					
Max	18.044	1.881	5.043	153.756	17.312	54.426	2.891					
Cumul	463.551	51.977	118.130	3954.627	393.232	1036.800	7.754			30j 21:04:00		
VLE Flux Jour	0	0	0	1	0	0	0					

* Le 06/07/2019, dépassement de la valeur flux jour en NOx sur la ligne 2 à 153,759 Kg (pour un seuil à 153,6 Kg) (cf. Fiche d'incident N° 19-008)



Rapport DREAL Flux Mensuel Ligne 2

Rapport Flux Mensuel												Aout 2019	
FLUX Ligne 2													
CO	COT	HCL	NOX	POUSSIERE	SO2	NH3	MarcheFourL2						
Unité Kg	Kg	Kg	Kg	Kg	Kg	Kg	hh:mm:ss	hh:mm:ss					
VLE Jour	19.2	153.6	19.2	96	19.2	19.2							
01/08/2019	14.151	1.012	1.190	96.835	11.609	22.847	1.492	20:05:10					
02/08/2019	13.692	1.047	0.393	137.997	9.321	28.383	0.184	24:00:00					
03/08/2019	13.421	1.172	1.397	140.728	10.332	23.320	0.101	24:00:00					
04/08/2019	7.130	0.704	1.125	74.796	6.133	7.094	0.048	14:10:50					
05/08/2019	1.267	0.158	0.032	13.952	0.333	0.225	0.014	03:28:50					
06/08/2019	9.907	1.159	0.191	100.857	3.966	3.998	0.028	22:38:40					
07/08/2019	13.913	1.266	1.964	113.217	16.803	4.420	0.108	24:00:00					
08/08/2019	12.278	1.164	1.670	120.753	7.187	4.816	0.093	24:00:00					
09/08/2019	14.008	1.228	1.586	108.627	11.836	5.670	0.063	23:58:00					
10/08/2019	14.242	1.124	0.580	110.299	10.140	5.155	0.108	22:59:40					
11/08/2019	13.269	1.227	1.075	134.446	7.915	20.886	0.106	24:00:00					
12/08/2019	8.330	0.791	4.651	83.976	6.332	13.331	0.030	15:58:10					
13/08/2019	Arrêt	Arrêt	Arrêt	Arrêt	Arrêt	Arrêt	Arrêt	00:00:00					
14/08/2019	Arrêt	Arrêt	Arrêt	Arrêt	Arrêt	Arrêt	Arrêt	00:00:00					
15/08/2019	7.724	0.476	1.043	57.275	6.512	3.668	0.045	12:24:20					
16/08/2019	13.973	0.963	3.261	128.246	6.870	22.593	0.042	24:00:00					
17/08/2019	13.977	1.098	1.672	131.238	8.546	27.540	0.071	24:00:00					
18/08/2019	13.568	1.091	1.079	130.039	11.967	28.675	0.093	24:00:00					
19/08/2019	12.481	1.039	1.781	121.504	8.407	11.408	0.021	24:00:00					
20/08/2019	13.038	1.041	2.534	117.881	9.500	11.193	0.029	24:00:00					
21/08/2019	12.599	0.969	1.738	124.494	7.118	11.116	0.027	24:00:00					
22/08/2019	11.268	0.954	2.386	127.744	8.055	16.335	0.062	24:00:00					
23/08/2019	11.548	1.048	2.370	123.610	8.762	11.584	0.016	24:00:00					
24/08/2019	11.022	0.999	2.653	131.265	7.308	17.347	0.082	24:00:00					
25/08/2019	10.929	1.063	2.523	127.292	8.848	17.156	0.076	24:00:00					
26/08/2019	13.965	1.168	2.541	127.139	9.122	13.493	0.041	24:00:00					
27/08/2019	11.773	1.095	2.329	130.030	10.415	5.478	0.017	24:00:00					
28/08/2019	11.019	1.201	1.824	121.848	8.500	3.179	0.153	24:00:00					
29/08/2019	16.103	1.392	1.827	128.739	11.659	2.340	0.163	24:00:00					
30/08/2019	11.089	1.245	2.737	119.046	10.997	2.068	0.090	24:00:00					
31/08/2019	11.578	1.239	2.583	136.825	12.809	4.460	0.136	24:00:00					
Min	1.267	0.158	0.032	13.952	0.333	0.225	0.014						
Max	16.103	1.392	4.651	140.728	16.803	28.675	1.492						
Cumul	343.262	30.133	52.725	3320.698	257.302	349.778	3.539						
VLE Flux Jour	0	0	0	0	0	0	0		26j 15:43:40				



Rapport DREAL Flux Mensuel Ligne 2

Rapport Flux Mensuel											Septembre 2019	
FLUX Ligne 2												
CO	COT	HCL	NOx	POUSSIERE	SO2	NH3	MarcheFourL2					
Unité Kg	Kg	Kg	Kg	Kg	Kg	Kg	hh:mm:ss					
VLE Jour	57,61	19,2	19,2	153,6	19,2	96	19,2					
01/09/2019	11.738	1.258	1.333	136.854	13.669	4.986	0.180	24:00:00				
02/09/2019	11.869	1.238	2.694	117.810	13.125	4.267	0.042	24:00:00				
03/09/2019	11.533	1.276	2.678	104.596	11.743	5.529	0.005	24:00:00				
04/09/2019	10.378	1.128	3.099	105.509	11.686	4.950	0.034	22:34:40				
05/09/2019	13.596	1.162	1.684	130.844	11.111	3.831	0.002	23:56:00				
06/09/2019	10.897	1.207	4.306	128.083	14.121	3.615	0.068	24:00:00				
07/09/2019	11.937	1.325	2.263	128.482	15.383	4.132	0.093	24:00:00				
08/09/2019	11.556	1.317	2.360	134.139	11.999	4.548	0.040	24:00:00				
09/09/2019	11.606	1.314	6.205	127.499	12.606	3.238	0.082	24:00:00				
10/09/2019	11.961	1.277	2.512	132.285	14.193	7.535	0.002	24:00:00				
11/09/2019	12.003	1.219	3.721	128.511	12.243	8.394	0.150	24:00:00				
12/09/2019	12.743	1.298	2.514	131.205	10.813	7.201	0.104	24:00:00				
13/09/2019	11.745	1.310	2.777	129.416	9.175	18.887	0.137	24:00:00				
14/09/2019	13.041	1.253	3.391	134.730	12.763	10.630	0.171	24:00:00				
15/09/2019	11.749	1.219	2.550	130.625	11.122	7.041	0.115	24:00:00				
16/09/2019	12.343	1.185	2.151	147.674	10.221	5.856	0.044	23:50:10				
17/09/2019	12.183	1.175	1.950	134.436	11.385	5.445	0.181	23:35:20				
18/09/2019	11.570	1.198	2.147	123.604	13.978	5.075	0.064	24:00:00				
19/09/2019	12.584	1.225	2.185	135.311	13.199	5.918	0.015	24:00:00				
20/09/2019	11.043	1.163	3.051	133.068	10.124	4.918	0.099	24:00:00				
21/09/2019	11.043	1.147	2.919	146.415	11.082	6.844	0.135	24:00:00				
22/09/2019	10.835	1.284	2.340	147.711	8.233	10.248	0.004	24:00:00				
23/09/2019	11.461	1.303	2.484	143.276	10.502	8.090	0.046	24:00:00				
24/09/2019	12.191	1.279	2.083	142.314	12.203	6.922	0.092	24:00:00				
25/09/2019	13.627	1.274	2.637	136.525	12.922	8.388	0.138	24:00:00				
26/09/2019	13.569	1.309	3.260	138.759	16.494	12.028	0.186	24:00:00				
27/09/2019	13.597	1.245	2.355	130.389	11.625	8.100	0.101	24:00:00				
28/09/2019	14.358	1.264	2.225	139.483	14.755	7.741	0.056	24:00:00				
29/09/2019	13.167	1.300	2.233	143.056	14.976	7.239	0.018	24:00:00				
30/09/2019	13.321	1.255	2.444	136.667	15.427	7.154	0.097	24:00:00				
Min	10.378	1.128	1.333	104.596	8.233	3.238	0.002					
Max	14.358	1.325	6.205	147.711	16.494	18.887	0.186					
Cumul	365.910	37.407	80.551	3979.276	372.878	208.750	2.501					
VLE Flux Jour	0	0	0	0	0	0	0		29j 21:56:10			



Rapport DREAL Flux Mensuel Ligne 2

Rapport Flux Mensuel													Octobre 2019	
FLUX Ligne 2														
CO	COT	HCL	NOX	POUSSIERE	SO2	NH3	Marche							
Unité Kg	Kg	Kg	Kg	Kg	Kg	Kg	hh	mm:ss						
VLE Jour	57.61	19.2	19.2	153.6	19.2	96	19.2							
01/10/2019	13.219	1.244	3.069	141.540	18.047	7.328	0.088					24:00:00		
02/10/2019	12.890	1.224	2.204	147.226	9.692	4.480	0.156					24:00:00		
03/10/2019	11.431	1.113	1.819	142.926	11.941	1.722	0.097					24:00:00		
04/10/2019	11.166	1.092	1.015	144.223	9.821	1.331	0.057					24:00:00		
05/10/2019	11.859	1.098	2.672	144.841	7.998	3.849	0.076					24:00:00		
06/10/2019	11.519	1.130	0.701	146.692	11.004	3.029	0.104					24:00:00		
07/10/2019	11.574	1.091	2.814	131.993	11.241	1.804	0.048					24:00:00		
08/10/2019	12.870	1.226	1.865	133.701	14.345	4.581	0.226					24:00:00		
09/10/2019	11.800	1.182	1.774	140.828	10.746	3.060	0.042					24:00:00		
10/10/2019	10.839	1.103	2.130	126.514	10.263	4.104	0.398					24:00:00		
11/10/2019	11.905	1.142	2.746	133.862	11.460	8.580	0.110					23:52:00		
12/10/2019	11.341	1.164	2.979	141.658	9.885	10.266	0.008					24:00:00		
13/10/2019	10.986	1.258	2.880	142.524	10.117	11.801	0.150					24:00:00		
14/10/2019	11.181	1.219	2.078	138.517	9.542	12.140	0.105					23:51:40		
15/10/2019	11.432	1.260	1.981	137.066	15.015	11.685	0.050					24:00:00		
16/10/2019	10.913	1.237	1.884	128.646	7.149	8.813	0.137					24:00:00		
17/10/2019	12.212	1.408	1.946	138.588	10.075	13.837	0.164					24:00:00		
18/10/2019	12.495	1.406	2.443	129.143	16.470	8.057	0.220					24:00:00		
19/10/2019	12.865	1.251	1.700	139.503	17.001	1.098	0.068					24:00:00		
20/10/2019	13.119	1.306	1.605	142.021	13.962	7.203	0.040					24:00:00		
21/10/2019	13.470	1.339	1.716	132.484	12.553	4.326	0.240					24:00:00		
22/10/2019	15.703	1.290	1.281	124.847	15.647	0.001	0.121					24:00:00		
23/10/2019	15.249	1.200	1.583	126.122	8.782	0.000	0.206					24:00:00		
24/10/2019	15.606	1.195	2.489	115.990	7.216	0.868	0.081					24:00:00		
25/10/2019	16.013	1.303	1.527	141.992	8.679	0.596	0.140					24:00:00		
26/10/2019	15.243	1.242	1.834	142.232	5.920	0.153	0.154					24:00:00		
27/10/2019	15.978	1.307	1.562	143.248	5.710	0.098	0.219					1j01:00:00		
28/10/2019	13.863	1.178	1.178	135.509	4.755	0.048	0.141					24:00:00		
29/10/2019	13.561	1.180	0.933	130.280	6.352	0.000	0.088					23:20:50		
30/10/2019	14.548	1.188	1.016	123.759	5.152	0.119	0.138					24:00:00		
31/10/2019	13.614	1.120	0.935	112.471	3.833	0.000	0.101					22:18:00		
Min	10.839	1.091	0.701	112.471	3.833	0.000	0.008							
Max	16.013	1.408	3.069	147.226	18.047	13.837	0.398							
Cumul	400.464	37.638	58.359	4200.946	320.373	134.977	3.973					30j 22:22:30		
VLE Flux Jour	0	0	0	0	0	0	0							

Rapport DREAL Flux Mensuel Ligne 2

Rapport Flux Mensuel												Novembre 2019	
FLUX Ligne 2													
CO	GOT	HCL	NOx	POUSSIERE	SO2	NH3	Marché Four L2						
Unité Kg	Kg	Kg	Kg	Kg	Kg	Kg	hh:mm:ss	hh:mm:ss					
VLE Jour	19.2	19.2	19.2	153.6	19.2	96	19.2	19.2					
01/11/2019	14.505	1.274	1.167	132.665	5.308	0.016	0.312	24:00:00					
02/11/2019	14.138	1.167	1.801	130.905	5.395	0.020	0.098	24:00:00					
03/11/2019	13.785	1.185	1.621	133.470	5.635	0.666	0.124	24:00:00					
04/11/2019	14.518	1.170	1.448	125.308	4.716	0.000	0.082	24:00:00					
05/11/2019	15.319	1.226	1.197	130.676	9.871	0.105	0.200	24:00:00					
06/11/2019	14.681	1.224	1.296	110.555	7.225	0.892	0.225	24:00:00					
07/11/2019	14.744	1.179	1.532	129.758	4.945	0.754	0.259	24:00:00					
08/11/2019	14.477	1.213	0.886	134.541	5.140	0.000	0.165	24:00:00					
09/11/2019	15.489	1.277	0.958	147.089	7.921	0.000	0.230	24:00:00					
10/11/2019	15.543	1.329	1.059	141.690	10.284	0.000	0.127	24:00:00					
11/11/2019	14.467	1.329	0.966	143.340	6.544	0.000	0.150	24:00:00					
12/11/2019	14.730	1.293	1.015	142.490	8.428	0.000	0.118	24:00:00					
13/11/2019	14.427	1.271	1.134	139.204	8.514	0.072	0.151	24:00:00					
14/11/2019	14.727	1.273	1.740	139.693	9.597	1.122	0.162	24:00:00					
15/11/2019	14.157	1.270	1.199	134.678	6.129	1.054	0.169	24:00:00					
16/11/2019	15.193	1.336	1.255	143.227	5.976	7.394	0.131	24:00:00					
17/11/2019	13.875	1.228	1.140	129.916	5.934	11.260	0.175	24:00:00					
18/11/2019	14.882	1.204	1.087	128.352	4.751	1.638	0.086	24:00:00					
19/11/2019	14.373	1.231	1.156	139.980	6.090	2.268	0.158	24:00:00					
20/11/2019	13.634	1.205	0.973	120.541	5.413	3.913	0.076	23:28:30					
21/11/2019	14.984	1.248	1.027	139.552	5.352	17.925	0.103	24:00:00					
22/11/2019	14.810	1.090	1.135	133.175	6.409	11.628	0.294	24:00:00					
23/11/2019	15.108	1.030	1.302	135.834	7.494	5.208	0.107	24:00:00					
24/11/2019	15.057	1.107	1.199	136.346	8.465	4.102	0.200	24:00:00					
25/11/2019	17.154	1.065	1.480	135.432	7.044	7.469	0.146	24:00:00					
26/11/2019	15.826	0.973	2.167	130.799	7.622	2.010	0.125	24:00:00					
27/11/2019	16.768	0.927	2.138	127.590	5.975	5.626	0.116	24:00:00					
28/11/2019	16.375	0.964	2.593	129.366	10.011	4.428	0.089	24:00:00					
29/11/2019	14.724	0.872	2.471	120.710	10.448	8.785	0.228	22:48:10					
30/11/2019	17.208	1.018	1.124	141.716	11.180	3.492	3.846	24:00:00					
Min	13.634	0.872	0.886	110.555	4.716	0.000	0.076						
Max	17.208	1.336	2.593	147.089	11.180	17.925	3.846						
Cumul	449.678	35.178	41.266	4008.598	213.816	101.847	8.452		29j 22:16:40				
VLE Flux Jour	0	0	0	0	0	0	0						

Rapport DREAL Flux Mensuel Ligne 2

Rapport Flux Mensuel											Decembre 2019	
FLUX Ligne 2												
CO	CO ₂	HCL	NOx	POUSSIÈRE	SO ₂	NH ₃	Marche Four L2					
Unité Kg	Kg	Kg	Kg	Kg	Kg	Kg	hh:mm:ss					
VLE Jour	57,61	19,2	19,2	153,6	19,2	96	19,2					
01/12/2019	16.966	1.035	1.084	136.082	7.771	3.005	0.202	24:00:00				
02/12/2019	16.721	1.099	0.999	134.182	7.591	3.519	0.128	24:00:00				
03/12/2019	15.967	1.167	1.126	131.848	9.159	2.312	0.093	24:00:00				
04/12/2019	17.457	1.218	1.233	127.711	11.029	11.184	0.164	24:00:00				
05/12/2019	17.460	1.306	1.035	123.780	7.788	3.283	0.087	24:00:00				
06/12/2019	16.657	1.238	0.975	125.220	7.920	14.418	0.112	24:00:00				
07/12/2019	16.881	1.177	1.354	130.384	9.653	9.532	0.196	24:00:00				
08/12/2019	17.521	1.144	2.184	127.685	8.558	13.553	0.182	24:00:00				
09/12/2019	18.295	1.147	1.314	126.319	11.168	6.199	0.115	24:00:00				
10/12/2019	15.883	1.183	1.849	125.804	8.022	1.978	0.170	24:00:00				
11/12/2019	16.280	1.158	1.371	128.304	7.965	5.969	0.147	24:00:00				
12/12/2019	15.824	1.144	1.210	127.178	7.681	0.064	0.160	24:00:00				
13/12/2019	16.946	1.089	1.211	124.551	7.190	0.883	0.138	23:59:30				
14/12/2019	16.865	1.135	1.418	145.259	11.041	0.078	0.175	24:00:00				
15/12/2019	15.730	1.083	1.515	154.264	7.669	0.002	0.129	24:00:00				
16/12/2019	16.738	1.185	1.414	136.979	9.024	0.057	0.302	24:00:00				
17/12/2019	15.399	1.068	2.289	129.608	7.872	0.157	0.201	24:00:00				
18/12/2019	15.674	1.108	1.443	123.721	6.073	0.136	0.125	24:00:00				
19/12/2019	14.648	0.982	2.603	134.283	5.350	6.145	0.103	24:00:00				
20/12/2019	17.178	1.060	1.875	121.140	6.924	0.253	0.164	24:00:00				
21/12/2019	17.106	1.121	1.478	125.928	7.563	2.619	0.230	24:00:00				
22/12/2019	16.138	1.150	1.547	125.812	7.292	0.001	0.130	24:00:00				
23/12/2019	18.118	1.273	1.421	124.551	7.431	0.300	0.162	24:00:00				
24/12/2019	15.978	1.263	1.396	126.591	6.042	0.029	0.198	24:00:00				
25/12/2019	15.138	1.226	1.119	130.897	4.585	0.001	0.145	24:00:00				
26/12/2019	15.748	1.293	0.993	129.794	5.443	0.014	0.173	24:00:00				
27/12/2019	16.378	1.194	1.106	125.264	6.500	0.165	0.116	24:00:00				
28/12/2019	16.425	1.223	0.951	128.724	7.509	0.000	0.215	24:00:00				
29/12/2019	15.299	1.203	1.047	130.468	5.542	0.018	0.143	24:00:00				
30/12/2019	15.598	1.237	1.193	129.127	4.664	1.463	0.318	24:00:00				
31/12/2019	17.037	1.146	0.910	128.254	5.911	10.977	2.917	23:49:20				
Min	14.648	0.982	0.910	121.140	4.585	0.000	0.087					
Max	18.295	1.306	2.603	154.264	11.168	14.418	2.917					
Cumul	510.053	36.055	42.663	4019.712	233.930	98.314	7.840					
VLE Flux Jour	0	0	0	1	0	0	0		30j 23:48:50			

* Le 16/12/2019, dépassement de la valeur flux jour en NOx à 154,264 kg (pour un seuil à 153,6 kg) suite à une mauvaise régulation d'injection d'ammoniac DENOX (cf. Fiche d'incident N° 19-016).

The first part of the document discusses the importance of maintaining accurate records of all transactions. It emphasizes that every entry should be supported by a valid receipt or invoice. This not only helps in tracking expenses but also ensures compliance with tax regulations.

In the second section, the author provides a detailed breakdown of the monthly budget. It includes categories for housing, utilities, food, and entertainment. The goal is to allocate funds wisely to avoid overspending and to save for future needs.

The third section covers the topic of debt management. It offers strategies for paying off credit cards and loans efficiently. The author suggests prioritizing high-interest debts and making regular payments to avoid penalties and interest accumulation.

Finally, the document concludes with advice on long-term financial planning. It encourages the reader to set clear financial goals and to review their progress regularly. Consistent saving and investing are highlighted as key factors for achieving financial stability and growth.



Rapport DREAL Mensuel Ligne 2

Rapport Mensuel		Messure IC 95 Mensuel L2																	Janvier 2019						
Unités	CO	CO2	HCL	NOx	POUSSIÈRE	SO2	NH3	Vitesse	O2	TDS L2	MarcheFour.L2	Tonnage OM L2	Tonnage DASRI L2	Ratio Jour L2											
VLE Jour	50	100	10	10	90	10	50	10	%	degreC	h:mm:ss	Tonne	Tonne												
VLE Mixt	100	100	20	10	150	150	10	10																	
Seuil Min.	100	100	20	10	160	30	200	20	15		850														
VLE 1/2h	6.16	6.23	0.93	0.87	64.69	5.08	1.13	0.08	19.74	9.35	23:58:10	322.4	322.4	1.5											
01/01/2019	6.16	6.23	0.93	0.87	64.69	5.08	1.13	0.08	19.74	9.35	23:58:10	322.4	322.4	1.5											
02/01/2019	0.87	0.87	0.91	0.70	62.71	4.78	2.11	0.03	4.78	9.59	1007.3	1007.3	1007.3	0.2											
03/01/2019	6.66	6.66	0.91	0.70	62.62	4.79	1.09	0.03	20.02	9.59	24:00:00	288.3	288.3	0.7											
04/01/2019	6.82	6.82	0.71	0.71	62.17	4.52	1.66	0.00	19.68	9.67	24:00:00	1009.7	1009.7	0.9											
05/01/2019	7.37	7.37	1.14	0.52	57.71	5.18	1.15	0.46	19.64	9.67	23:52:50	304.6	304.6	0.0											
06/01/2019	6.16	6.16	0.86	0.67	61.63	5.21	1.65	0.01	19.27	9.77	24:00:00	1002.1	1002.1	1.7											
07/01/2019	7.42	7.42	0.98	0.77	59.41	6.04	1.80	0.05	19.68	10.31	20:54:10	202.3	202.3	5.4											
08/01/2019	7.27	7.27	0.95	0.74	61.24	7.44	1.47	0.01	20.38	9.91	24:00:00	252.7	252.7	5.8											
09/01/2019	6.87	6.87	0.86	0.60	61.49	5.55	1.39	0.00	20.68	10.11	24:00:00	282.8	282.8	0.6											
10/01/2019	7.07	7.07	0.85	0.75	59.73	6.94	1.39	0.00	20.68	10.11	24:00:00	250.0	250.0	9.8											
11/01/2019	7.41	7.41	0.86	0.78	59.46	7.90	1.13	0.06	20.73	10.16	24:00:00	266.8	266.8	1.4											
12/01/2019	6.92	6.92	0.87	0.72	61.49	5.57	1.08	0.00	20.35	9.81	24:00:00	287.3	287.3	0.0											
13/01/2019	6.91	6.91	0.87	0.59	62.77	4.80	1.65	0.02	20.10	9.61	24:00:00	285.7	285.7	0.2											
14/01/2019	6.28	6.28	1.17	0.89	61.03	5.16	2.13	0.06	20.06	9.84	24:00:00	278.8	278.8	9.1											
15/01/2019	7.44	7.44	0.89	0.89	61.37	5.62	1.57	0.18	20.01	9.92	21:04:00	241.0	241.0	6.0											
16/01/2019	7.13	7.13	0.85	0.72	63.20	6.39	0.86	0.03	20.37	9.83	24:00:00	262.2	262.2	6.5											
17/01/2019	6.82	6.82	0.80	0.74	62.46	6.01	1.30	0.06	20.19	9.98	24:00:00	241.8	241.8	4.88											
18/01/2019	8.11	8.11	0.84	0.66	62.75	6.20	1.03	0.08	20.22	9.91	24:00:00	239.7	239.7	14.1											
19/01/2019	7.28	7.28	0.72	0.64	62.50	7.54	0.64	0.02	20.79	10.10	24:00:00	254.5	254.5	9.19											
20/01/2019	6.69	6.69	0.75	0.61	62.88	5.39	0.71	0.09	20.51	10.01	24:00:00	274.8	274.8	9.5											
22/01/2019	6.91	6.91	0.72	0.68	62.72	6.69	0.66	0.09	20.80	9.82	24:00:00	247.7	247.7	19.0											
23/01/2019	6.88	6.88	0.63	0.66	63.06	6.24	0.97	0.00	20.49	9.83	24:00:00	239.1	239.1	28.6											
24/01/2019	6.33	6.33	0.67	0.75	63.28	6.08	0.85	0.03	20.89	9.81	24:00:00	251.0	251.0	20.0											
25/01/2019	6.69	6.69	0.71	0.89	60.63	6.47	1.45	0.02	20.08	10.08	24:00:00	256.5	256.5	27.0											
26/01/2019	5.29	5.29	0.71	0.89	65.58	5.03	1.11	0.02	20.08	10.08	24:00:00	271.0	271.0	10.59											
27/01/2019	5.90	5.90	0.78	0.79	64.56	5.09	1.11	0.02	18.54	9.30	24:00:00	236.5	236.5	14.55											
28/01/2019	6.11	6.11	0.77	0.94	65.33	3.99	1.35	0.05	20.11	9.59	24:00:00	278.4	278.4	21.3											
29/01/2019	6.12	6.12	0.77	0.62	64.49	4.66	1.25	0.06	19.91	9.65	24:00:00	266.0	266.0	6.80											
30/01/2019	6.12	6.12	0.68	0.79	63.61	4.41	2.34	0.01	19.62	9.57	24:00:00	272.9	272.9	7.29											
31/01/2019	6.81	6.81	0.69	0.74	65.07	4.76	2.73	0.07	19.65	9.57	24:00:00	287.8	287.8	5.5											
Max.	8.11	8.11	1.14	1.17	65.58	8.41	2.73	0.46	20.80	10.31	1009.7	322.4	322.4	34.4											
Min.	5.29	5.29	0.69	0.52	57.71	3.99	0.47	0.00	18.54	9.30	961.2	282.3	282.3	0.9											
Dep. VLE Jour	0	0	0	0	0	0	0	0	0	0	0	0	0	0											
Nb Jour Inva.	0	0	0	0	0	0	0	0	0	0	0	0	0	0											
Dep. VLE Max	00:00	00:00	00:00	00:00	00:00	00:00	00:00	00:00	00:00	00:00	00:00	00:00	00:00	00:00											
Dep. Seuil Min.	1	1	0	0	4	2	0	0	00:00	00:00	00:00	00:00	00:00	00:00											
Dep. VLE 1/2h	6.80	6.80	0.81	0.74	62.71	5.81	1.30	0.05	20.08	9.79	301 17:49:10	8359.1	8359.1	332.6											
Moy. Mensuelle	6.99	6.99	0.80	0.60	60.00	6.00	0.90	0.00	0.00	0.00	0	0.0	0.0	0.0											
% données HG	9.00	9.00	0.00	0.00	0.00	0.00	0.00	0.00	0.00	0.00	0	0.0	0.0	0.0											
% données HG Annuel	9.00	9.00	0.00	0.00	0.00	0.00	0.00	0.00	0.00	0.00	0	0.0	0.0	0.0											

Contrôle réglementaire L2 - 2019 HCL										CO		SO2		NOx		CO2		Global	
Dépassement >4H										Dep. VLE		Nb. jour invalides		Indis. Cons >10h		Indisponibilité			
0										0		0		0		0		0	
00:00										01:00		00:30		00:00		00:00		00:00	
0										0		0		0		0		0	
00:00										00:00		00:00		00:00		00:00		00:00	

* Le 01/01/2019, dépassement d'une moyenne 30' en NOx à 187,17 mg/Nm3 (pour une limite à 160) suite à la mise en sécurité par bypass du traitement fumées dû à un défaut mesure bobinage du ventilateur de tirage travaux.
 * Le 05/01/2019, dépassement de deux moyennes 30' en NOx à 193,14 mg/Nm3 et à 184,92 mg/Nm3 (pour une limite à 160) et d'une moyenne en CO à 129,77 mg/Nm3 (pour une limite à 100) suite à la mise en sécurité par bypass de la DENOX suite à une pression haute en entrée DENOX.
 * Le 06/01/2019, dépassement d'une moyenne 30' en NOx à 169,97 mg/Nm3 (pour une limite à 160) suite à la mise en sécurité par bypass de la DENOX suite à une pression haute en entrée DENOX.
 * Le 15/01/2019, dépassement de deux moyennes 30' en Poussières à 75,65 mg/Nm3 et à 31,10 mg/Nm3 (pour une limite à 30) suite à un bouchage de la trémie OM (balle de papier).



Rapport DREAL Mensuel Ligne 2

Rapport Mensuel															Février 2019	
Mésure IC 95 Mensuel L2																
Unités	CO	COT	HCL	NOx	POUSSIERE	SO2	NH3	Vitesse	O2	T2S L2	Marché/Pond.L2	Tonnage OM L2	Tonnage DASRI L2	Kano Jour L2		
VLE Jour	50	100	20	10	10	150	50	10	%	degreC	hh:mm:ss	Tonnage	Tonnage	Tonnage		
VLE Max	100	100	20	10	150	150	50	10				Tonnage	Tonnage	Tonnage		
Seuil Min.	100	100	20	10	150	150	50	10				Tonnage	Tonnage	Tonnage		
VLE 1/2h	100	100	20	10	150	150	50	10				Tonnage	Tonnage	Tonnage		
01/02/2019	6.61	0.70	0.70	0.99	66.88	5.77	9.25	0.01	19.63	9.36	985.3	24:00:00	275.3	13.4		
02/02/2019	6.82	0.76	0.76	0.84	64.34	7.90	4.12	0.01	20.24	9.69	980.6	24:00:00	292.5	3.1		
03/02/2019	6.23	0.75	0.75	0.72	65.18	6.35	5.56	0.03	20.37	9.53	979.2	24:00:00	392.4	0.0		
04/02/2019	6.09	0.75	0.75	0.69	64.72	4.96	4.18	0.04	20.20	9.57	975.4	24:00:00	316.0	7.6		
05/02/2019	6.10	0.76	0.76	0.85	64.90	4.53	5.88	0.01	20.06	9.57	975.7	24:00:00	294.1	6.1		
06/02/2019	6.17	0.79	0.79	0.99	63.74	5.84	4.42	0.02	20.29	9.74	983.0	24:00:00	248.0	7.7		
07/02/2019	5.92	0.86	0.86	1.11	64.31	4.38	12.05	0.00	19.94	9.46	981.6	24:00:00	263.2	9.6		
08/02/2019	5.98	0.91	0.91	0.97	62.77	4.90	12.73	0.05	19.97	9.39	982.7	24:00:00	221.7	2.4		
09/02/2019	6.21	0.89	0.89	0.92	62.51	3.93	9.71	0.03	20.06	9.45	977.9	24:00:00	305.2	0.0		
10/02/2019	5.72	0.83	0.83	0.77	63.28	3.93	16.77	0.03	19.80	9.32	972.4	24:00:00	315.2	0.4		
11/02/2019	6.17	0.83	0.83	0.86	61.59	5.62	13.54	0.07	19.68	9.56	971.1	24:00:00	307.4	2.9		
12/02/2019	5.83	0.80	0.80	0.83	62.74	3.65	4.35	0.02	19.30	9.42	968.6	24:00:00	314.3	3.25		
13/02/2019	5.89	0.76	0.76	0.64	62.65	3.77	4.40	0.87	19.49	9.49	970.5	24:00:00	305.6	9.8		
14/02/2019	5.45	0.77	0.77	0.83	63.45	3.92	3.86	0.01	19.35	9.38	970.8	24:00:00	279.6	7.58		
15/02/2019	5.71	0.74	0.74	0.92	63.80	3.61	3.41	0.06	19.24	9.27	978.9	24:00:00	245.1	6.45		
16/02/2019	5.57	0.89	0.89	0.85	62.93	5.27	4.92	0.01	19.47	9.44	970.7	24:00:00	296.4	3.8		
17/02/2019	5.98	0.86	0.86	0.98	63.19	5.01	3.96	0.10	19.90	9.33	974.7	24:00:00	325.3	1.0		
18/02/2019	6.11	0.83	0.83	0.96	62.37	5.21	4.24	0.03	20.02	9.52	972.0	24:00:00	289.4	6.3		
19/02/2019	5.75	0.64	0.64	1.05	61.18	4.66	4.51	0.07	19.82	9.71	972.0	24:00:00	241.4	8.1		
20/02/2019	6.06	0.45	0.45	1.02	61.70	4.95	3.55	0.09	19.69	9.63	972.0	24:00:00	248.1	3.26		
21/02/2019	5.86	0.51	0.51	0.98	61.88	5.21	4.09	0.08	19.85	9.63	970.4	24:00:00	228.2	11.8		
22/02/2019	5.79	0.66	0.66	0.90	62.26	4.48	4.20	0.03	19.95	9.55	971.9	24:00:00	308.3	0.3		
23/02/2019	5.58	0.65	0.65	1.08	61.33	5.14	5.43	0.06	19.85	9.51	971.4	24:00:00	319.6	0.0		
24/02/2019	5.90	0.78	0.78	1.49	61.79	6.25	9.27	0.07	19.71	9.66	963.7	24:00:00	310.1	0.2		
25/02/2019	6.18	1.04	1.04	1.07	61.69	4.94	5.42	0.05	19.59	9.74	964.4	24:00:00	249.5	12.2		
26/02/2019	6.01	0.85	0.85	1.07	62.35	5.37	3.77	0.06	19.71	9.54	965.0	24:00:00	215.1	8.8		
27/02/2019	6.82	0.94	0.94	1.49	66.88	7.90	16.77	0.37	20.37	9.74	985.3	24:00:00	266.9	9.5		
28/02/2019	5.45	0.45	0.45	0.64	61.18	3.61	3.41	0.00	19.24	9.27	963.7	24:00:00	293.2	6.0		
Dep. VLE jour	0	0	0	0	0	0	0	0	0	0	0	0	0	0		
Nb Jour inv.	0	0	0	0	0	0	0	0	0	0	0	0	0	0		
Dep. VLE Max	0	0	0	0	0	0	0	0	0	0	0	0	0	0		
Dep. Seuil Min.	0	0	0	0	0	0	0	0	0	0	0	0	0	0		
Dep. VLE 1/2h	0	0	0	0	0	0	0	0	0	0	0	0	0	0		
Moy. Mensuelle	6.00	0.78	0.78	0.94	63.00	5.06	6.26	0.07	19.81	9.52	973.5	283:00:00	7967.1	186.3		
% données HG	0.00	0.00	0.00	0.00	0.00	0.00	0.00	0.00	0.00	0.00	0.00	0.00	0.00	0.00		
% données HG Annuel	0.00	0.00	0.00	0.00	0.00	0.00	0.00	0.00	0.00	0.00	0.00	0.00	0.00	0.00		

Contraint réglementaire L2 - 2019										Global	
CO	SO2	NOx	COT	NH3	Vitesse	O2	T2S L2	Marché/Pond.L2	Tonnage OM L2	Tonnage DASRI L2	Kano Jour L2
00:00	00:30	00:00	02:00	00:00	00:00	00:00	00:00	00:00	00:00	00:00	00:00
00:00	00:30	00:00	02:00	00:00	00:00	00:00	00:00	00:00	00:00	00:00	00:00
00:00	00:00	00:00	00:00	00:00	00:00	00:00	00:00	00:00	00:00	00:00	00:00
00:00	00:00	00:00	00:00	00:00	00:00	00:00	00:00	00:00	00:00	00:00	00:00
00:00	00:00	00:00	00:00	00:00	00:00	00:00	00:00	00:00	00:00	00:00	00:00



Rapport DREAL Mensuel Ligne 2

Rapport Mensuel															Mars 2019	
Mesure IC 95 Mensuel L2																
Unités	CO	COT	HCL	NOx	POUSSIÈRE	SO2	NH3	Vitesse	O2	T2S L2	Marche/Forç.L2	Tonnage OM L2	Tonnage DASRI L2	Ratio Jour L2		
VLE Jour	50	mg/Nm3	10	mg/Nm3	10	mg/Nm3	50	10	%	degreC	h/mn/ss	Tonne	Tonne	-		
VLE Max	100		20		150											
Seuil Min.	100		20		30				15		850					
VLE 1/2h																
01/03/2019	6.29	0.83	61.14	1.02	6.23	3.21	20.08	9.73	20.08	9.73	964.0	24.00:00	282.0	3.6		
02/03/2019	0.83	0.97	61.71	0.97	6.17	6.17	20.19	9.62	20.19	9.62	972.2	24.00:00	293.8	1.5		
03/03/2019	5.88	0.89	61.71	0.89	5.51	5.51	20.11	9.55	20.11	9.55	977.6	24.00:00	304.1	0.2		
04/03/2019	6.26	0.89	61.85	0.96	6.72	4.01	19.79	9.60	19.79	9.60	981.7	24.00:00	298.4	4.6		
05/03/2019	6.16	0.90	60.77	1.17	5.32	4.74	19.79	9.79	19.79	9.79	969.7	24.00:00	324.4	1.54		
06/03/2019	6.49	0.88	61.95	1.17	5.81	6.34	20.11	9.55	20.11	9.55	966.6	24.00:00	369.1	8.5		
07/03/2019	5.85	0.88	62.35	0.95	5.92	4.93	20.14	9.50	20.14	9.50	966.4	24.00:00	331.1	3.6		
08/03/2019	5.96	0.81	61.76	1.00	5.48	4.33	20.05	9.60	20.05	9.60	964.6	24.00:00	324.5	8.5		
09/03/2019	6.47	0.79	61.89	1.02	5.81	4.07	19.98	9.57	19.98	9.57	964.3	24.00:00	322.8	3.7		
10/03/2019	6.34	0.88	62.57	0.91	5.64	6.36	19.87	9.43	19.87	9.43	957.5	24.00:00	322.8	2.9		
11/03/2019	6.68	0.89	60.70	0.89	5.85	4.63	19.84	9.75	19.84	9.75	967.9	24.00:00	336.1	4.8		
12/03/2019	6.58	0.58	62.50	1.09	7.00	4.34	19.48	9.48	19.48	9.48	967.4	24.00:00	282.6	13.6		
13/03/2019	7.55	0.45	62.20	1.13	5.73	11.56	19.52	9.54	19.52	9.54	967.3	24.00:00	276.8	8.09		
14/03/2019	7.90	0.27	61.14	1.89	6.22	11.16	19.49	9.70	19.49	9.70	967.8	24.00:00	292.0	22.4		
15/03/2019	7.92	0.00	61.06	2.76	6.08	8.35	19.06	9.72	19.06	9.72	967.8	24.00:00	299.3	16.1		
16/03/2019	8.73	0.01	61.91	2.69	7.98	8.64	19.65	9.63	19.65	9.63	966.8	24.00:00	296.7	10.2		
17/03/2019	8.93	0.08	60.88	2.50	6.79	7.14	19.79	9.69	19.79	9.69	968.7	24.00:00	296.7	7.2		
18/03/2019	10.17	0.16	60.45	2.08	6.29	9.98	19.28	9.82	19.28	9.82	970.6	24.00:00	278.4	2.6		
19/03/2019	8.91	0.01	60.37	1.99	6.62	15.24	18.76	9.85	18.76	9.85	971.6	24.00:00	336.7	0.0		
20/03/2019	8.98	0.00	59.70	1.91	6.94	10.18	19.12	9.99	19.12	9.99	970.9	24.00:00	255.2	6.1		
21/03/2019	8.79	0.09	60.73	1.76	6.02	11.16	18.66	9.72	18.66	9.72	977.8	24.00:00	244.5	7.0		
22/03/2019	8.86	0.00	60.96	1.73	4.70	11.43	18.11	9.70	18.11	9.70	973.7	23:51:10	292.4	11.1		
23/03/2019	10.19	0.00	77.29	1.13	6.55	8.92	18.51	9.50	18.51	9.50	912.1	23:51:10	268.2	4.5		
24/03/2019	7.99	0.00	63.02	1.29	6.73	19.26	18.80	9.63	18.80	9.63	958.3	24.00:00	307.7	4.6		
25/03/2019	7.84	0.00	66.08	1.27	6.56	9.99	18.89	9.69	18.89	9.69	959.5	24.00:00	150.6	0.0		
26/03/2019	7.41	0.00	64.22	1.83	5.94	10.12	18.75	10.09	18.75	10.09	955.1	24.00:00	311.5	0.0		
27/03/2019	7.48	0.00	61.13	1.61	7.21	14.87	19.01	9.92	19.01	9.92	955.1	24.00:00	295.8	0.0		
28/03/2019	7.66	0.00	60.94	1.58	5.27	14.87	18.75	9.92	18.75	9.92	962.7	24.00:00	311.5	0.0		
29/03/2019	7.91	0.00	61.33	1.52	6.09	5.98	19.01	9.78	19.01	9.78	962.6	24.00:00	252.7	11.8		
30/03/2019	7.27	0.00	61.69	1.75	8.80	8.41	18.91	9.77	18.91	9.77	960.6	24.00:00	300.4	16.2		
31/03/2019	5.87	0.00	58.11	1.41	5.93	5.79	18.36	9.64	18.36	9.64	966.5	24.00:00	281.6	12.0		
Max.	10.19	0.90	77.29	2.76	8.80	19.26	20.27	10.09	14.00	9.81	948.6	23:00:00	320.4	0.0		
Min.	5.85	0.00	58.11	0.89	4.70	2.17	14.99	9.43	14.99	9.43	961.7	24.00:00	150.6	0.0		
Nb. Jour Inva.	0	0	0	0	0	0	0	0	0	0	0	0	0	0		
Dep. VLE Jour	0	0	0	0	0	0	0	0	0	0	0	0	0	0		
Dep. VLE Max	0	0	0	0	0	0	0	0	0	0	0	0	0	0		
Dep. Seuil Min.	0	0	0	0	0	0	0	0	0	0	0	0	0	0		
Dep. VLE 1/2h	0	0	0	3	3	0	24.00	0	24.00	0	0	0	0	0		
Max. Mennobte	7.45	0.36	61.79	1.73	6.33	8.15	19.21	9.70	19.21	9.70	965.3	30j 10:00:00	9023.9	210.8		
% données HG	0.00	0.00	0.00	0.00	0.00	0.00	0.00	0.00	0.00	0.00	0.0	0.0	0.0	0.0		
% données HG Annuel	0.00	0.00	0.00	0.00	0.00	0.00	0.00	0.00	0.00	0.00	0.0	0.0	0.0	0.0		

Contrôle réglementaire L2 - 2019 HCL									
CO	SO2	NOx	COT	NH3	Global				
0	0	0	0	0	0				
02:30	00:30	00:00	02:00	00:00	00:30				
0	0	0	0	0	0				
0	0	0	0	0	0				
00:00	00:00	00:00	00:00	00:00	00:00				

* Le 03/03/2019, dépassement d'une moyenne 30' en Poussières à 38,77 mg/Nm3 (pour une limite à 30) suite à un excès d'air dans le four lors d'une mauvaise combustion.

* Le 15/03/2019, dépassement d'une moyenne 30' en Poussières à 54,33 mg/Nm3 (pour une limite à 30) suite à un excès d'air dans le four et une vitesse élevée du ventilateur de tirage.

* Le 23/03/2019 => dépassement de trois moyennes 30' en HCl à 109,21 mg/Nm3 et à 138,21 mg/Nm3 (pour une limite à 60) suite au black OUT; => dépassement d'une moyenne 30' en Poussières à 40,99 mg/Nm3 (pour une limite à 30) et d'une moyenne 30' en NH3 à 24,22 mg/Nm3 (pour une limite à 20) suite à la relance de la ligne après le black out et le blocage du registre entrée laveurs.



Rapport DREAL Mensuel Ligne 2

Rapport Mensuel

Mesure IC 93 Mensuel L2															Avril 2019	
Unité	CO	COT	HCL	NOx	POUSSIÈRE	SO2	NH3	Vitesse	O2	T2S L2	Marche/Point	Tonnage OM L2	Tonnage DASRI L2	Ratio Jour L2		
VLE Jour	mg/Nm3	mg/Nm3	mg/Nm3	mg/Nm3	mg/Nm3	mg/Nm3	mg/Nm3	m/s	%	degreC	h/mn/ss	Tonne	Tonne	-		
VLE Max	50	100	10	10	80	10	50	10	15	850						
Seuil Min.	100	100	20	60	160	150	200	20								
VLE 1/2h	20															
01/04/2019	8,38		0,00	1,43	58,42	7,93	4,38	0,02	18,17	9,70	955,8	24,00:00	298,6	6,9		
02/04/2019	8,65		0,00	1,31	62,69	8,00	4,30	0,04	19,00	9,53	962,4	24,00:00	254,7	3,1		
03/04/2019	10,49		0,04	1,17	62,42	7,02	3,19	0,00	18,72	9,54	962,6	24,00:00	283,2	6,5		
04/04/2019	7,94		0,00	1,27	76,95	5,81	5,81	0,05	17,90	9,58	964,2	13:30:20	150,0	3,5		
05/04/2019	9,45		0,00	1,66	72,67	7,24	9,05	0,05	18,63	9,64	959,8	24,00:00	311,2	9,3		
06/04/2019	8,15		0,00	1,85	73,01	6,51	14,09	0,00	18,82	9,56	963,7	24,00:00	311,3	7,9		
07/04/2019	7,26		0,00	1,58	71,25	6,49	13,08	0,03	18,09	9,75	960,3	24,00:00	294,3	1,5		
08/04/2019	7,29		0,00	1,59	68,76	9,36	17,58	0,06	17,42	9,98	968,3	24,00:00	215,3	6,2		
09/04/2019	7,13		0,00	1,47	71,51	6,72	13,11	0,05	19,16	9,87	962,7	24,00:00	267,8	7,8		
10/04/2019	6,55		0,00	1,52	69,12	4,00	25,19	0,00	18,71	9,79	956,6	24,00:00	263,5	4,4		
11/04/2019	5,90		0,00	1,55	68,15	3,34	30,80	0,01	18,37	9,73	967,6	24,00:00	266,7	5,17		
12/04/2019	6,35		0,00	1,45	68,62	4,42	10,29	0,03	18,72	9,66	967,2	24,00:00	274,4	7,4		
13/04/2019	6,39		0,00	1,40	68,19	5,22	15,47	0,01	19,20	9,70	969,5	24,00:00	316,5	0,00		
14/04/2019	6,00		0,00	1,42	67,53	4,58	16,47	0,01	18,61	9,76	974,4	24,00:00	299,9	7,0		
15/04/2019	6,89		0,00	2,19	64,20	7,55	12,41	0,02	18,76	9,98	947,5	24,00:00	279,6	8,48		
16/04/2019	5,77		0,04	1,14	69,32	6,85	16,72	0,00	11,62	9,65	972,4	24,00:00	288,1	27,1		
17/04/2019	0,25		0,00	0,80	68,64	4,97	13,29	0,02	18,65	9,70	965,6	24,00:00	259,5	29,6		
18/04/2019	5,35		0,09	1,01	69,95	4,78	7,94	0,00	18,72	9,32	977,3	24,00:00	251,9	8,39		
19/04/2019	0,96		0,01	0,70	70,31	6,68	9,28	0,02	18,67	9,39	976,6	24,00:00	213	13,7		
20/04/2019	Arret		Arret	Arret	Arret	Arret	Arret	Arret	Arret	Arret	Arret	00:00:00	0,0	0,00		
21/04/2019	6,43		0,07	1,16	68,07	7,62	16,72	0,73	17,17	9,99	975,7	13:26:30	132,7	8,82		
22/04/2019	6,48		0,12	0,94	70,49	7,30	18,40	0,04	18,40	9,42	990,2	20:06:40	246,1	4,7		
23/04/2019	7,60		0,17	0,85	69,30	7,17	8,64	0,02	19,04	9,56	989,9	24,00:00	263,7	15,1		
24/04/2019	6,33		0,30	0,56	68,62	8,37	0,03	0,03	19,01	9,69	990,6	24,00:00	278,4	18,5		
25/04/2019	6,38		0,33	0,91	66,86	8,51	0,23	0,06	19,08	9,91	987,6	24,00:00	237,5	8,72		
26/04/2019	6,48		0,13	1,22	67,27	7,48	2,21	0,04	18,89	9,92	986,6	24,00:00	285,3	9,03		
27/04/2019	6,70		0,04	1,31	66,47	6,14	3,05	0,02	19,01	10,00	987,1	24,00:00	244	8,55		
28/04/2019	6,85		0,06	0,87	64,95	7,01	3,06	0,01	18,92	10,11	989,2	24,00:00	266,8	7,72		
29/04/2019	8,17		0,11	0,67	70,99	5,50	2,06	0,44	18,14	10,70	973,9	15:04:10	158,8	8,1		
30/04/2019	7,97		0,60	0,50	65,99	5,43	2,65	0,37	17,74	10,04	993,4	23:58:50	193,6	11,31		
Max.	18,49		0,33	2,19	76,95	9,36	38,88	0,73	19,20	10,76	993,4	316,5	29,6	11,41		
Min.	5,35		0,00	0,56	58,42	3,34	0,03	0,00	11,62	9,39	947,5	0,0	0,0	0,00		
Nb Jour Inva.	0		0	0	0	0	0	0	0	0	0	0	0	0		
Dep. VLE Jour	0		0	0	0	0	0	0	0	0	0	0	0	0		
Dep. VLE Max	0		0	0	0	0	0	0	0	0	0	0	0	0		
Dep. Seuil Min.	00:00		00:00	00:00	00:00	00:00	00:00	00:00	00:00	00:00	00:00	00:00	00:00	00:00		
Dep. VLE 1/2h	4		1	0	4	11	0	1	24:00	9,77	972,4	27j 14:06:30	7511,0	364,6		
Moy. Mensuelle	8,00		0,00	1,25	68,66	6,81	10,53	0,10	18,33	9,77	972,4	0,0	0,0	0,0		
% données HG	8,00		0,00	0,00	0,00	0,00	0,00	0,00	0,00	0,00	0,0	0,0	0,0	0,0		
% données HG Annuel	8,00		0,00	0,00	0,00	0,00	0,00	0,00	0,00	0,00	0,0	0,0	0,0	0,0		

Contrôle réglementaire L2 - 2019 HCL									
CO	POUSSIÈRE	SO2	NOx	NH3	COT	NBB	Global		
0	0	0	0	0	0	0	0		
Dep. VLE	01:30	08:00	02:30	00:00	04:00	00:30	01:00	15:30	
Nb jour invalides	0	0	0	0	0	0	0	0	
Indis. Cons >10h	0	0	0	0	0	0	0	0	
Indisponibilité	00:00	00:00	00:00	00:00	00:00	00:00	00:00	00:00	
							00:00	00:00	

- * Le 05/04/2019, dépassement d'une moyenne 30' en Poussières à 66,47 mg/Nm3 (pour une limite à 30) suite à une élévation de la vitesse du ventilateur de tirage (moyenne 1150 tr/min).
- * Le 07/04/2019, dépassement d'une moyenne 30' en Poussières à 55,90 mg/Nm3 (pour une limite à 30) lors d'une remontée brutale du débit vapeur.
- * Le 08/04/2019, dépassement d'une moyenne 30' en Poussières à 31,82 mg/Nm3 (pour une limite à 30) lors du contrôle réglementaire effectué par la société LECEs.
- * Le 15/04/2019, dépassement d'une moyenne 30' en Poussières à 32,00 mg/Nm3 (pour une limite à 30), suite à la vidanges de l'extracteur en eau de l'extracteur mâchefer.
- * Le 16/04/2019, dépassement d'une moyenne 30' en Poussières à 34,29 mg/Nm3 (pour une limite à 30), suite à un emballement du ventilateur de tirage sur trémie de chargement OM vide sans indication en supervision car les capteurs de niveau pas en fonctionnement pas.

RAPPORT DREAL MENSUEL LIGNE 2

AVRIL 2019

- Le 19/04/2019, dépassement d'une moyenne 30' en Poussières à 59,09 mg/Nm³ (pour une limite à 30) lors de l'arrêt de chargement de la ligne suite à un fortuit.
- Le 21/04/2019 :
 - Dépassement d'une moyenne 30' en CO à 102,75 mg/Nm³ (pour une limite à 100) lors de la reprise du chargement en OM après un fortuit. Un problème de fonctionnement des grilles est survenu lors du redémarrage.
 - Dépassement de deux moyennes 30' en Poussières à 36,85 mg/Nm³ et à 30,22 mg/Nm³ (pour une limite à 30) lors de la reprise du chargement en OM après fortuit. Un problème de fonctionnement des grilles est survenu lors du redémarrage.
- Le 22/04/2019, dépassement d'une moyenne 30' en Poussières à 43,63 mg/Nm³ (pour une limite à 30) suite à une élévation de la vitesse du ventilateur de tirage (moyenne 1150 tr/min).
- Le 29/04/2019, dépassement d'une moyenne 30' en CO à 142,47 mg/Nm³ (pour une limite à 100) et en NH₃ à 41,87 mg/Nm³ lors de la remontée trop rapide du débit vapeur suite à la reprise du chargement du four et suite à un disfonctionnement de la régulation d'injection d'ammoniaque.
- Le 30/04/2019, dépassement de quatre moyennes 30' en NOx à 234,76 mg/Nm³, à 284,50 mg/Nm³, à 263,16 mg/Nm³ et à 226,47 mg/Nm³ (pour une limite à 160), puis dépassement d'une moyenne 30' en CO et COT à 566,61 mg/Nm³ (pour une limite à 100) et à 24,50 mg/Nm³ (pour une limite à 20), puis dépassement d'une moyenne 30' en CO à 365,49 mg/Nm³ (pour une limite à 100) lors de la mise en sécurité par bypass de la DENOX.
- Le 30/04/2019, dépassement de deux moyennes 30' en Poussières à 62,75 mg/Nm³ et à 58,35 mg/Nm³ (pour une limite à 30) suite à une élévation de la vitesse du ventilateur de tirage (moyenne 1150 tr/min).



Rapport DREAL Mensuel Ligne 2

Rapport Mensuel

Mesure IC 95 Mensuel L2		Mai 2019														
Unité	CO	CO2	HCL	NOx	POUSSIÈRE	SO2	NH3	Vitesse	O2	T2S L2	MarcheForL2	Tonnage OM L2	Tonnage DASRI L2	Ratio	Avr L2	Mai 2019
VLE Jour	50	10	10	10	90	10	50	10	15	degréC	hh:mm:ss	Tonne	Tonne	-	-	-
VLE Max	100	20	20	60	150	30	200	20	15							
Seuil Min.	100	20	20	60	150	30	200	20	15							
VLE 1/2h	100	20	20	60	150	30	200	20	15							
01/05/2019	7.33	0.02	0.02	0.86	62.81	6.05	3.04	0.01	19.12	10.13	977.8	24:00:00	296.7	21.0	7.08	
02/05/2019	7.35	0.07	0.68	0.71	65.74	5.22	19.15	0.08	19.15	9.82	981.7	24:00:00	303.6	14.3	4.71	
03/05/2019	6.83	0.01	6.76	0.71	66.76	3.73	3.01	0.02	18.79	9.63	995.4	24:00:00	256.3	24.2	9.44	
04/05/2019	7.11	0.07	6.44	2.58	66.44	4.91	1.77	0.02	19.12	9.73	994.8	24:00:00	198.5	20.6	10.38	
05/05/2019	6.91	0.37	6.55	0.86	65.35	4.94	0.37	0.06	19.35	9.82	987.1	24:00:00	329.5	7.5	3.28	
06/05/2019	6.89	0.55	6.89	0.75	64.87	6.02	0.37	0.01	19.31	9.93	984.4	24:00:00	329.5	15.7	4.76	
07/05/2019	6.93	0.95	6.03	1.11	66.03	6.13	1.36	0.02	10.91	9.84	986.4	24:00:00	306.0	21.5	7.03	
08/05/2019	7.02	0.97	6.97	1.19	69.75	4.68	0.93	0.08	7.83	9.51	986.5	24:00:00	280.1	2.4	0.86	
09/05/2019	7.14	0.97	6.94	0.90	69.74	5.20	1.08	0.02	7.61	9.63	986.9	24:00:00	353.4	3.5	0.99	
10/05/2019	7.62	1.00	6.57	1.00	67.71	4.49	1.20	0.00	7.13	9.83	986.1	24:00:00	261.1	1.1	0.42	
11/05/2019	7.30	0.99	6.40	0.91	66.40	4.05	0.96	0.07	8.88	10.10	986.4	24:00:00	319.5	1.8	0.56	
12/05/2019	6.19	1.17	6.85	1.17	68.56	2.72	2.59	0.09	9.37	9.72	993.4	24:00:00	203.8	1.7	0.83	
13/05/2019	7.23	0.94	6.85	0.94	65.85	7.82	2.45	0.01	8.24	10.15	985.2	24:00:00	179.5	10.9	6.07	
14/05/2019	6.75	0.87	6.82	0.82	72.49	4.67	2.34	0.00	8.57	10.08	989.2	24:00:00	348.7	12.5	3.58	
15/05/2019	6.67	0.85	6.75	0.85	76.51	3.28	2.54	0.04	8.26	9.79	987.5	24:00:00	327.3	11.9	3.64	
16/05/2019	6.93	0.85	6.93	0.80	75.44	4.19	2.47	0.01	7.35	9.99	985.1	24:00:00	315.7	12.4	3.93	
17/05/2019	7.07	0.88	6.66	0.88	70.75	4.93	1.35	0.01	8.08	9.72	985.6	24:00:00	256.5	10.0	3.90	
18/05/2019	8.62	1.00	8.62	0.98	67.15	4.94	1.01	0.04	17.99	9.96	979.6	16:23:40	192.0	2.4	1.25	
19/05/2019	Arrêt	Arrêt	Arrêt	Arrêt	Arrêt	Arrêt	Arrêt	Arrêt	Arrêt	Arrêt	Arrêt	00:00:00	0.0	0.0	0.00	
20/05/2019	Arrêt	Arrêt	Arrêt	Arrêt	Arrêt	Arrêt	Arrêt	Arrêt	Arrêt	Arrêt	Arrêt	00:00:00	0.0	0.0	0.00	
21/05/2019	Arrêt	Arrêt	Arrêt	Arrêt	Arrêt	Arrêt	Arrêt	Arrêt	Arrêt	Arrêt	Arrêt	00:00:00	0.0	0.0	0.00	
22/05/2019	Arrêt	Arrêt	Arrêt	Arrêt	Arrêt	Arrêt	Arrêt	Arrêt	Arrêt	Arrêt	Arrêt	00:00:00	0.0	0.0	0.00	
23/05/2019	Arrêt	Arrêt	Arrêt	Arrêt	Arrêt	Arrêt	Arrêt	Arrêt	Arrêt	Arrêt	Arrêt	00:00:00	0.0	0.0	0.00	
24/05/2019	Arrêt	Arrêt	Arrêt	Arrêt	Arrêt	Arrêt	Arrêt	Arrêt	Arrêt	Arrêt	Arrêt	00:00:00	0.0	0.0	0.00	
25/05/2019	Arrêt	Arrêt	Arrêt	Arrêt	Arrêt	Arrêt	Arrêt	Arrêt	Arrêt	Arrêt	Arrêt	00:00:00	0.0	0.0	0.00	
26/05/2019	Arrêt	Arrêt	Arrêt	Arrêt	Arrêt	Arrêt	Arrêt	Arrêt	Arrêt	Arrêt	Arrêt	00:00:00	0.0	0.0	0.00	
27/05/2019	Arrêt	Arrêt	Arrêt	Arrêt	Arrêt	Arrêt	Arrêt	Arrêt	Arrêt	Arrêt	Arrêt	00:00:00	0.0	0.0	0.00	
28/05/2019	Arrêt	Arrêt	Arrêt	Arrêt	Arrêt	Arrêt	Arrêt	Arrêt	Arrêt	Arrêt	Arrêt	00:00:00	0.0	0.0	0.00	
29/05/2019	Arrêt	Arrêt	Arrêt	Arrêt	Arrêt	Arrêt	Arrêt	Arrêt	Arrêt	Arrêt	Arrêt	00:00:00	0.0	0.0	0.00	
30/05/2019	Arrêt	Arrêt	Arrêt	Arrêt	Arrêt	Arrêt	Arrêt	Arrêt	Arrêt	Arrêt	Arrêt	00:00:00	0.0	0.0	0.00	
31/05/2019	Arrêt	Arrêt	Arrêt	Arrêt	Arrêt	Arrêt	Arrêt	Arrêt	Arrêt	Arrêt	Arrêt	00:00:00	0.0	0.0	0.00	
Max.	8.62	1.00	7.58	1.11	76.51	7.82	3.04	0.09	19.35	10.15	995.4	353.4	24.2	10.38	0.00	
Min.	6.19	0.01	6.57	0.71	62.81	2.72	0.37	0.00	7.13	9.51	977.8	0.0	0.0	0.00	0.00	
Dep. VLE jour	0	0	0	0	0	0	0	0	0	0	0	0	0	0	0	
Nb Jour Inva.	0	0	0	0	0	0	0	0	0	0	0	0	0	0	0	
Dep. VLE Max	00:00	00:00	00:00	00:00	00:00	00:00	00:00	00:00	00:00	00:00	00:00	00:00	00:00	00:00	00:00	
Dep. Seuil Min.	0	0	0	0	0	0	0	0	0	0	0	0	0	0	0	
Dep. VLE 1/2h	0	0	0	0	0	0	0	0	0	0	0	0	0	0	0	
Moy. Mensuelle	7.08	0.63	6.96	0.96	68.26	4.95	1.77	0.03	12.41	9.85	986.7	17j 16:23:40	4957.2	195.4	0.00	
% données HG	0.00	0.00	0.00	0.00	0.00	0.00	0.00	0.00	0.00	0.00	0.00	0.00	0.00	0.00	0.00	
% données HC	0.00	0.00	0.00	0.00	0.00	0.00	0.00	0.00	0.00	0.00	0.00	0.00	0.00	0.00	0.00	
Annulé																

Contrôle supplémentaire L2 - 10/19 HCL															
Dépassement >4H		POUSSIÈRE		CO		SO2		NOx		CO2		NH3		Global	
Dep.	VLE	01:30	09:00	0	0	0	0	0	0	0	0	0	0	0	0
Nb jour invalides	0	0	0	0	0	0	0	0	0	0	0	0	0	0	0
Indis. Cons >10h	0	0	0	0	0	0	0	0	0	0	0	0	0	0	0
Indisponibilité	00:00	00:00	00:00	00:00	00:00	00:00	00:00	00:00	00:00	00:00	00:00	00:00	00:00	00:00	00:00
* Le 13/05/2019, dépassement de deux moyennes 30' en Poussières à 36,50 mg/Nm3 et à 31,76 mg/Nm3 (pour une limite à 30) suite à une élévation de la vitesse du ventilateur de tirage (moyenne 1150 tr/min).															
* Du 07/05/2019 au 17/05/2019, mesure de vitesse incohérente => attente de retour ENVEA.															



Rapport DREAL Mensuel Ligne 2

Rapport Mensuel														Juin 2019	
Mégarec IC 95 Meneval L2															
Unités	CO	COF	HCL	NOx	POUSSIÈRE	SO2	NH3	Vitesse	O2	TPS L2	Marche/Point L2	Tonnage OM L2	Tonnage DASRI L2	Rabot Jour L2	
VLE Jour	mg/Nm3	mg/Nm3	mg/Nm3	mg/Nm3	mg/Nm3	mg/Nm3	mg/Nm3	m/s	%	degréC	h:mm:ss	Tonnage	Tonnage		
VLE Max	100	100	20	10	150	10	50	10	15		850				
Scalé Min.	100		20	60	160	30	200	20							
VLE 1/2h															
01/06/2019	Arrêt	Arrêt	Arrêt	Arrêt	Arrêt	Arrêt	Arrêt	Arrêt	Arrêt	Arrêt	Arrêt	00:00:00	0.0	0.0	0.00
02/06/2019	Arrêt	Arrêt	Arrêt	Arrêt	Arrêt	Arrêt	Arrêt	Arrêt	Arrêt	Arrêt	Arrêt	00:00:00	0.0	0.0	0.00
03/06/2019	Arrêt	Arrêt	Arrêt	Arrêt	Arrêt	Arrêt	Arrêt	Arrêt	Arrêt	Arrêt	Arrêt	00:00:00	0.0	0.0	0.00
04/06/2019	Indisponible	Indisponible	Indisponible	Indisponible	Indisponible	Indisponible	Indisponible	Indisponible	Indisponible	Indisponible	Indisponible	00:00:00	0.0	0.0	0.00
05/06/2019	Arrêt	Arrêt	Arrêt	Arrêt	Arrêt	Arrêt	Arrêt	Arrêt	Arrêt	Arrêt	Arrêt	00:00:00	0.0	0.0	0.00
06/06/2019	Arrêt	Arrêt	Arrêt	Arrêt	Arrêt	Arrêt	Arrêt	Arrêt	Arrêt	Arrêt	Arrêt	00:00:00	0.0	0.0	0.00
07/06/2019	Arrêt	Arrêt	Arrêt	Arrêt	Arrêt	Arrêt	Arrêt	Arrêt	Arrêt	Arrêt	Arrêt	00:00:00	0.0	0.0	0.00
08/06/2019	Arrêt	Arrêt	Arrêt	Arrêt	Arrêt	Arrêt	Arrêt	Arrêt	Arrêt	Arrêt	Arrêt	00:00:00	0.0	0.0	0.00
09/06/2019	12.88	1.34	1.44	1.56	11.63	1.44	1.34	1.44	1.56	11.14	930.3	07:22:30	202.2	0.0	0.00
10/06/2019	11.21	1.40	1.40	2.03	63.73	6.40	10.13	0.02	18.44	10.95	939.6	24:00:00	212.6	0.0	0.00
11/06/2019	11.07	1.49	1.49	2.22	59.86	8.55	4.90	0.02	18.44	10.95	948.2	24:00:00	133.3	7.4	5.55
12/06/2019	10.45	1.41	1.41	3.54	55.90	3.62	3.09	0.00	17.96	11.84	955.3	24:00:00	166.5	40.4	7.92
13/06/2019	12.55	1.43	1.43	1.93	69.61	6.02	0.00	0.03	17.74	9.59	970.7	22:52:00	40.4	3.2	7.92
14/06/2019	10.17	1.04	1.04	2.04	72.50	4.42	0.00	0.11	18.63	9.27	972.1	24:00:00	339.6	6.4	1.88
15/06/2019	9.41	0.40	0.40	2.23	75.89	4.27	0.00	0.07	18.38	8.91	975.6	24:00:00	355.4	5.0	1.41
16/06/2019	9.42	1.86	1.86	1.86	69.51	3.94	0.00	0.06	17.90	9.15	987.9	24:00:00	272.0	0.5	0.18
17/06/2019	9.07	1.71	1.71	1.71	66.27	5.03	0.00	0.01	18.21	9.04	992.1	24:00:00	209.9	15.6	5.42
18/06/2019	10.43	3.51	3.51	3.51	73.13	9.27	2.95	0.03	18.60	9.40	989.6	24:00:00	252.1	24.9	9.88
19/06/2019	9.67	1.55	1.55	3.14	64.86	5.87	8.88	0.13	17.96	9.80	979.2	24:00:00	300.4	21.4	7.12
20/06/2019	9.28	0.43	0.43	2.35	43.49	5.24	0.22	0.02	18.62	8.95	1000.6	24:00:00	321.1	5.5	1.71
21/06/2019	10.79	0.48	0.48	2.23	33.31	5.63	0.50	0.29	17.57	9.08	1007.6	24:00:00	368.3	1.6	0.43
22/06/2019	8.23	0.43	0.43	2.36	71.95	5.27	0.26	0.13	17.57	8.73	1000.6	24:00:00	409.1	0.2	0.05
23/06/2019	7.99	0.93	0.93	2.35	66.14	5.74	0.00	0.07	17.92	8.97	1010.5	24:00:00	357.4	21.4	5.99
24/06/2019	7.80	1.86	1.86	1.86	74.29	5.45	10.60	0.06	18.79	9.00	1005.0	24:00:00	253.6	23.1	8.44
25/06/2019	7.77	1.66	1.66	1.66	68.85	6.05	19.00	0.03	18.22	9.03	1003.7	24:00:00	278.5	22.5	8.08
26/06/2019	8.10	0.81	0.81	1.42	68.32	5.49	17.70	0.07	18.53	9.05	1014.1	24:00:00	345.4	10.2	2.95
27/06/2019	12.88	1.75	1.75	3.54	75.89	9.27	27.71	0.29	19.59	11.84	1017.5	24:00:00	326.5	4.5	1.38
28/06/2019	7.77	0.48	0.48	0.95	33.31	3.62	0.00	0.00	15.98	8.73	930.3	24:00:00	409.1	0.0	0.00
29/06/2019	00:00	0	0	0	00:00	0	0	0	0	0	0	0	0	0	0
30/06/2019	00:00	0	0	0	00:00	0	0	0	0	0	0	0	0	0	0
31/06/2019	00:00	0	0	0	00:00	0	0	0	0	0	0	0	0	0	0
Max.	12.88	1.75	1.75	3.54	75.89	9.27	27.71	0.29	19.59	11.84	1017.5	24:00:00	409.1	24.9	11.11
Min.	7.77	0.48	0.48	0.95	33.31	3.62	0.00	0.00	15.98	8.73	930.3	24:00:00	326.5	4.5	1.38
Dep. VLE Jour	0	0	0	0	0	0	0	0	0	0	0	0	0	0	0
NB Jour Inva.	1	1	1	1	1	1	1	1	1	1	1	0	0	0	0
Dep. VLE Max	00:00	0	0	0	00:00	0	0	0	0	0	0	0	0	0	0
Dep. Scall Min.															
Dep. VLE 1/2h	1	0	0	0	0	0	0	0	0	0	0	0	0	0	0
Moy. Mensuelle	9.96	0.30	0.30	2.13	66.20	5.89	5.59	0.07	18.27	9.49	987.0	20j 16:24:28	5095.1	256.1	7.92
% dijonées HG	0.00	0.00	0.00	0.00	0.00	0.00	0.00	0.00	0.00	0.00	0.00	0.00	0.00	0.00	0.00
% dijonées HG Annuel	0.00	0.00	0.00	0.00	0.00	0.00	0.00	0.00	0.00	0.00	0.00	0.00	0.00	0.00	0.00

Contrôle réglementaire L2 - 2019 HCL														Global									
POUSSIÈRE														COF		NH3		NOx					
Dep. VLE	01:30	10:30	1	1	1	1	1	00:00	04:00	0	0	00:30	01:00	0	0	0	0	0	0	0	0		
NB jour invalides	1	1	1	1	1	1	1	1	1	1	1	1	1	1	1	1	1	1	1	1	1	1	
Indis. Cons >10h	0	0	0	0	0	0	0	0	0	0	0	0	0	0	0	0	0	0	0	0	0	0	
Indisponibilité	04:00	04:00	04:00	04:00	04:00	04:00	04:00	04:00	04:00	04:00	04:00	04:00	04:00	04:00	04:00	04:00	04:00	04:00	04:00	04:00	04:00	04:00	04:00
Depassement >4H	0	0	0	0	0	0	0	0	0	0	0	0	0	0	0	0	0	0	0	0	0	0	0
Global	0	0	0	0	0	0	0	0	0	0	0	0	0	0	0	0	0	0	0	0	0	0	0

* Le 04/06/2019, coupure électrique générale EDF lors de l'arrêt technique lignes EME
 * Le 09/06/2019, dépassement de deux moyennes 30' en Pousssières à 39.63 mg/Nm3 et à 31.84 mg/Nm3 (pour une limite à 30) lors du redémarrage de la ligne.
 * Le 12/06/2019, dépassement d'une moyenne 30' en Pousssières à 41.16 mg/Nm3 pour une limite à 30) suite à une remontée brutale du débit vapeur.
 * Le 24/06/2019, dépassement d'une moyenne 30' en CO à 104.69 mg/Nm3 (pour une limite à 100) suite à une explosion dans le four



Rapport DREAL Mensuel Ligne 2

Rapport Mensuel															Juillet 2019	
Mesure IC 95 Mensuel L2																
Unité	CO	COT	HCL	NOx	POUSSIERE	SO2	NH3	Vitesse	O2	TDS L2	Marchés/For.L2	Tonnage OM L2	Tonnage DASRL2	Ratio Jour L2		
VLE Jour	50	100	10	10	80	10	50	m/s	%	degreC	tkm:ms	Tonne	Tonne			
VLE Max	100	100	20	10	150	150	200	30	15							
Seuil Min.	100	100	20	60	160	30	200	20			850					
VLE 1/2h	100	100	20	60	160	30	200	20								
01/07/2019	7.91	8.96	0.82	1.41	68.94	5.29	19.91	0.02	18.41	8.98	1004.3	24.00.00	199.4	7.3		
02/07/2019	7.94	8.96	0.85	2.03	65.96	6.40	21.86	0.05	18.51	9.53	995.5	24.00.00	281.6	12.3		
03/07/2019	7.63	8.96	0.82	1.98	66.24	7.20	27.20	0.08	18.30	9.37	1000.3	24.00.00	201.3	16.2		
04/07/2019	7.62	8.96	0.82	2.20	69.23	6.27	22.37	0.01	18.23	9.40	998.6	24.00.00	285.1	12.8		
05/07/2019	8.45	8.96	0.78	2.08	74.39	8.18	21.17	0.05	18.41	9.20	999.0	24.00.00	271.6	4.35		
06/07/2019	8.85	8.96	0.83	2.00	75.16	8.22	23.65	0.04	18.65	9.09	1000.9	24.00.00	296.8	5.2		
07/07/2019	7.61	8.96	0.84	1.81	69.45	7.44	18.46	0.02	18.71	9.15	1005.7	24.00.00	313.1	2.1		
08/07/2019	7.52	8.96	0.84	1.83	71.73	6.02	15.86	0.04	18.54	9.28	999.8	24.00.00	263.8	21.2		
09/07/2019	7.20	8.96	0.84	1.75	70.73	6.24	5.77	0.04	18.40	9.19	997.7	24.00.00	207.4	8.04		
10/07/2019	6.92	8.96	0.83	1.84	69.96	6.32	4.81	0.04	18.17	9.18	1000.5	24.00.00	146.5	13.55		
11/07/2019	6.94	8.96	0.85	1.56	69.72	6.52	4.20	0.04	18.15	9.11	1007.1	24.00.00	232.6	21.03		
12/07/2019	6.85	8.96	0.83	1.23	40.13	7.10	5.59	0.36	18.25	8.91	1009.2	24.00.00	223.6	29.5		
13/07/2019	6.87	8.96	0.87	2.40	65.28	6.13	20.07	0.03	18.46	9.11	1010.3	24.00.00	275.4	11.76		
14/07/2019	8.90	8.96	0.94	2.25	45.72	5.68	22.16	0.02	18.04	9.01	1014.0	24.00.00	233.2	7.01		
15/07/2019	6.51	8.96	0.88	2.26	47.62	5.68	19.12	0.03	18.16	9.04	1007.8	24.00.00	120.5	9.22		
16/07/2019	6.91	8.96	0.89	2.48	37.14	5.90	10.44	1.74	17.60	9.30	1007.2	24.00.00	179.8	24.48		
17/07/2019	7.47	8.96	0.88	1.33	50.32	6.96	13.65	0.03	17.48	9.76	1003.2	24.00.00	0.0	11.01		
18/07/2019	7.23	8.96	0.84	2.19	62.74	7.77	9.97	0.11	18.61	9.11	1008.7	24.00.00	0.0	0.00		
19/07/2019	7.75	8.96	0.86	1.65	71.27	4.70	15.84	0.10	18.95	9.32	1007.9	24.00.00	0.0	0.00		
20/07/2019	8.74	8.96	0.87	2.01	64.77	6.86	17.13	0.02	18.36	8.90	1019.3	24.00.00	0.0	0.00		
21/07/2019	8.96	8.96	0.87	1.98	67.34	5.69	16.19	0.08	18.81	9.33	1009.5	24.00.00	0.0	0.00		
22/07/2019	7.14	8.96	0.76	1.95	69.54	5.07	15.37	0.03	18.45	9.02	1015.4	24.00.00	31.2	0.00		
23/07/2019	7.19	8.96	0.73	1.86	68.52	4.94	18.83	0.05	18.13	8.86	1015.4	24.00.00	209.5	3.0		
24/07/2019	6.53	8.96	0.72	1.94	65.53	4.87	18.83	0.04	17.97	8.99	1020.5	24.00.00	284.3	11.4		
25/07/2019	6.84	8.96	0.81	1.55	72.78	3.94	25.03	0.02	17.59	8.74	1021.0	24.00.00	267.3	3.2		
26/07/2019	7.55	8.96	0.89	2.26	73.85	4.23	19.33	0.07	17.97	8.73	1015.6	24.00.00	291.8	0.00		
27/07/2019	7.30	8.96	0.86	2.56	72.64	6.50	20.12	0.01	18.23	8.55	1015.6	24.00.00	221.9	0.00		
28/07/2019	7.87	8.96	0.86	2.56	66.13	7.55	17.55	0.05	18.58	9.35	996.3	24.00.00	218.6	8.9		
29/07/2019	7.81	8.96	0.89	1.99	64.24	6.63	16.58	0.05	18.57	9.21	1009.6	24.00.00	313.2	7.8		
30/07/2019	7.74	8.96	0.90	2.12	64.75	6.05	19.73	0.02	18.58	9.17	1012.5	24.00.00	246.2	2.49		
31/07/2019	8.96	8.96	0.94	2.56	75.16	8.22	27.20	0.02	18.95	9.76	1021.0	24.00.00	313.2	0.00		
Max.	6.51	8.96	0.72	1.23	29.30	3.94	4.81	0.01	17.48	8.55	995.5	0.0	0.0	24.48		
Min.	0	0	0	0	0	0	0	0	0	0	0	0	0	0.00		
Nb Jour Inva.	0	0	0	0	0	0	0	0	0	0	0	0	0	0		
Dep. VLE Jour	00-00	00-00	00-00	00-00	00-00	00-00	00-00	00-00	00-00	00-00	00-00	00-00	00-00	00-00		
Dep. VLE Max	0	0	0	0	0	0	0	0	0	0	0	0	0	0		
Dep. Seuil Min.	0	0	0	0	0	0	0	0	0	0	0	0	0	0		
Dep. VLE 1/2h	0	0	0	0	0	4	0	1	00-00	0	00-00	0	0	0		
Moy. Mensuelle	7.50	1.92	0.84	0.80	63.58	6.36	16.73	0.14	18.33	9.14	1007.3	301 21-04-00	581.47	357.2		
% données HG	0.00	0.00	0.00	0.00	0.00	0.00	0.00	0.00	0.00	0.00	0.0	0	0.0	0.0		
% données HG	0.00	0.00	0.00	0.00	0.00	0.00	0.00	0.00	0.00	0.00	0.0	0	0.0	0.0		
Annuel																

Contrôle réglementaire L2 - 2019 HCL														
Dépassement >H														
Dep. VLE	01:30	12:30	03:00	00:00	04:00	00:00	00:30	00:00	01:30	00:00	00:30	00:00	01:30	00:00
Nb jour invalides	1	1	1	1	1	1	1	1	1	1	1	1	1	1
Indis: Cons >10h	0	0	0	0	0	0	0	0	0	0	0	0	0	0
Indisponibilité	04:00	04:00	04:00	04:00	04:00	04:00	04:00	04:00	04:00	04:00	04:00	04:00	04:00	04:00
* Le 12/07/2019, dépassement d'une moyenne 30' en NH3 (pour une limite à 20) suite au régulateur qui n'a pas été suffisamment réactif sur une baisse des NOx en cheminée.														
* Le 21/07/2019, dépassement d'une moyenne 30' en Poussières à 31.92 mg/Nm3 pour une limite à 30) suite à une remontée brutale du débit vapeur.														
* Le 29/07/2019, dépassement d'une moyenne 30' en Poussières à 46.82 mg/Nm3 pour une limite à 30) suite à une remontée brutale du débit vapeur.														
* Le 31/07/2019, dépassement de 2 moyennes 30' en Poussières à 57.39 mg/Nm3 et à 164.43 mg/Nm3 pour une limite à 30) suite à un bouchage de la trémie de chargement des OM, entraînant une entrée d'air parasite.														



Rapport DREAL Mensuel Ligne 2

Rapport Mensuel

Mesure IC 95 Mensuel L2															Aout 2019	
Unité	CO	CO2	HCL	NOx	POUSSIERE	SO2	NH3	Vitesse	O2	T2S L2	Marche/Fout.L2	Tonnage OML2	Tonnage DASRI L2	Ratio Jour L2		
VLE Jour	50	10	10	10	80	10	50	m/s	%	degreC	h:mm:ss	Tonne	Tonne			
VLE Max	100	20	20	60	150	150	10	10	15							
Seuil Min.																
VLE 1/2h	100	20	20	60	30	30	200	20	15		850					
01/08/2019	8.66	0.74	0.62	0.20	58.97	7.08	13.83	1.01	18.89	9.66	987.1	20:05:10	278.3	3.7		
02/08/2019	6.90	0.53	0.59	0.20	69.38	4.69	14.28	0.99	17.94	8.99	1010.7	24:00:00	308.6	0.1		
03/08/2019	6.76	0.70	0.64	1.21	70.67	5.17	11.81	0.05	18.20	9.12	1009.9	24:00:00	241.1	0.0		
04/08/2019	6.34	1.21	0.64	1.21	65.92	5.41	6.22	0.06	17.86	9.49	1003.8	14:10:50	159.8	0.0		
05/08/2019	5.75	0.15	0.74	0.15	64.05	1.52	1.01	0.07	14.31	9.71	985.9	03:28:50	4.7	0.0		
06/08/2019	6.39	0.79	0.79	0.12	63.42	2.41	2.50	0.02	15.63	9.47	987.4	22:38:40	110.0	0.0		
07/08/2019	7.62	0.69	0.69	1.03	61.36	7.59	2.35	0.06	17.96	9.72	981.0	24:00:00	323.2	0.0		
08/08/2019	6.65	0.92	0.65	0.92	65.00	3.78	2.58	0.05	17.29	9.20	1005.2	24:00:00	322.0	0.0		
09/08/2019	8.26	1.15	0.73	1.15	60.11	4.74	3.00	0.03	17.24	9.95	978.7	23:58:00	357.8	0.0		
10/08/2019	9.05	0.37	0.71	0.37	65.59	4.30	2.81	0.07	16.41	9.53	992.6	22:59:40	316.5	0.0		
11/08/2019	6.66	0.54	0.62	0.54	67.30	3.96	10.47	0.05	17.91	8.70	1007.6	24:00:00	336.9	0.0		
12/08/2019	6.57	5.09	0.64	5.09	62.80	5.07	10.34	0.03	17.62	9.29	989.3	15:58:10	187.1	0.0		
13/08/2019	Arrêt	Arrêt	Arrêt	Arrêt	Arrêt	Arrêt	Arrêt	Arrêt	Arrêt	Arrêt	Arrêt	00:00:00	0.0	0.0		
14/08/2019	Arrêt	Arrêt	Arrêt	Arrêt	Arrêt	Arrêt	Arrêt	Arrêt	Arrêt	Arrêt	Arrêt	00:00:00	0.0	0.0		
15/08/2019	8.35	1.12	0.52	1.12	61.11	7.12	3.78	0.05	17.40	9.47	978.6	12:24:20	178.8	0.0		
16/08/2019	7.19	0.50	0.50	1.70	65.87	3.51	11.65	0.02	17.36	9.00	997.2	24:00:00	298.0	0.0		
17/08/2019	7.04	0.55	0.55	0.84	66.08	4.30	13.89	0.04	18.05	8.96	994.1	24:00:00	345.2	0.0		
18/08/2019	6.82	0.55	0.55	0.54	65.20	5.99	14.59	0.05	18.35	8.93	994.1	24:00:00	304.7	0.0		
19/08/2019	6.67	1.00	0.57	1.00	64.36	4.34	6.13	0.01	17.30	9.36	985.9	24:00:00	274.4	1.28		
20/08/2019	6.83	0.55	0.55	1.34	61.29	4.88	5.82	0.02	17.87	9.69	1001.6	24:00:00	297.4	3.5		
21/08/2019	6.54	0.30	0.30	0.90	64.24	3.65	5.73	0.01	17.49	9.24	1001.6	24:00:00	308.2	4.4		
22/08/2019	5.72	0.49	0.49	1.22	64.73	4.09	6.13	0.03	17.75	9.23	998.7	24:00:00	314.6	4.35		
23/08/2019	5.91	1.22	0.54	1.22	63.14	4.45	5.88	0.01	18.15	9.38	1004.0	24:00:00	297.5	7.60		
24/08/2019	5.54	1.35	0.50	1.35	65.84	3.67	8.69	0.04	17.94	9.22	1004.0	24:00:00	346.6	11.3		
25/08/2019	5.62	0.55	0.55	1.29	65.02	4.48	8.82	0.02	18.13	9.23	998.4	24:00:00	294.0	6.1		
26/08/2019	7.02	1.34	0.59	1.34	64.16	4.59	6.79	0.02	18.10	9.91	977.9	24:00:00	279.1	18.8		
27/08/2019	6.51	1.29	0.59	1.29	68.48	5.38	2.78	0.01	18.10	9.91	977.9	24:00:00	285.0	6.74		
28/08/2019	6.30	0.71	0.71	1.20	67.42	4.47	1.66	0.02	16.87	9.79	973.4	24:00:00	277.7	11.6		
29/08/2019	8.33	0.96	0.72	0.96	66.17	5.93	1.18	0.08	18.40	10.82	986.1	24:00:00	261.1	9.77		
30/08/2019	6.18	1.83	0.73	1.83	65.06	5.68	1.07	0.05	17.14	10.64	976.1	24:00:00	262.7	6.81		
31/08/2019	5.77	1.28	0.62	1.28	68.15	6.38	2.22	0.07	18.82	9.49	993.3	24:00:00	323.4	5.07		
Max.	9.05	5.09	0.79	5.09	70.67	7.59	14.59	1.01	18.89	10.84	1010.7		346.6	25.5		
Min.	5.54	0.12	0.49	0.12	58.97	1.52	1.01	0.01	14.31	8.70	973.4		0.0	0.0		
Dep. VLE Jour	0	0	0	0	0	0	0	0	0	0	0		0.0	0.00		
Nb Jour Inva.	0	0	0	0	0	0	0	0	0	0	0		0	0		
Dep. VLE Max	00:00	00:00	00:00	00:00	00:00	00:00	00:00	00:00	00:00	00:00	00:00		0	0		
Dep. Seuil Min.	0	0	0	0	0	0	0	0	0	0	0		0	0		
Dep. VLE 1/2h	0	0	0	0	0	0	0	0	0	0	0		0	0		
Moy. Mensuelle	6.83	1.11	0.61	1.11	65.08	5.00	6.71	0.07	17.70	9.38	992.8	26j 15:43:40	7795.4	218.0		
% dimanches HG	0.00	0.00	0.00	0.00	0.00	0.00	0.00	0.00	0.00	0.00	0.00		0.0	0.0		
% dimanches HG	0.00	0.00	0.00	0.00	0.00	0.00	0.00	0.00	0.00	0.00	0.00		0.0	0.0		
Annuel																

Contrôle réglementaire L2 - 2019 HCL														
Dépassement >4H														
Dep. VLE	CO	POUSSIERE	SO2	NOx	CO2	NH3	Global							
01:30	0	0	0	0	0	0	0	0	0	0	0	0	0	0
Nb jour invalides	1	1	1	1	1	1	04:30	04:30	1	1	1	00:30	01:30	23:30
Indis. Cons >10h	0	0	0	0	0	0	0	0	0	0	0	0	0	0
Indisponibilité	04:00	04:00	04:00	04:00	04:00	04:00	04:00	04:00	04:00	04:00	04:00	04:00	04:00	04:00

* Le 07/08/2019, dépassement d'une moyenne 30' en Poussières à 64,29 mg/Nm3 (pour une limite à 30) suite à une remontée brutale du débit vapeur.
 * Le 09/08/2019, dépassement de deux moyennes 30' en Poussières à 42,32 mg/Nm3 et à 56,59 mg/Nm3 (pour une limite à 30) suite à une remontée brutale du débit vapeur.
 * Le 10/08/2019, dépassement d'une moyenne 30' en Poussières à 89,59 mg/Nm3 (pour une limite à 30) suite à une entrée d'air importante au niveau de la goulotte OM avant la fermeture du clapet.
 * Le 12/08/2019, dépassement d'une moyenne 30' en NOx à 164,54 mg/Nm3 (pour une limite à 160) suite au repli de la DeNOx sur pression basse air comprimé, intervention d'une société extérieure sur les compresseurs.



Rapport DREAL Mensuel Ligne 2

Rapport Mensuel															Septembre 2019	
Membre IC 95 Mensuel L2																
Unités	CO	COT	HCL	NOx	POUSSIÈRE	SO2	NH3	Vitesse	O2	T2S L2	Marché-Poll.2	Tonnage-OM L2	Tonnage-DASRI L2	Ratio Jour L2		
VLE Jour	10	50	10	10	80	10	50	10	%	degreC	kg/nm3	Tonne	Tonne			
VLE Max	20	100	20	150	150	150	200	10	15		850					
Seuil Min.	20	100	20	150	150	150	200	20	15		850					
VLE 1/2h	20	100	20	150	150	150	200	20	15		850					
01/09/2019	5.84		0.62	0.66	67.82	6.78	2.47	0.09	18.93	9.44	995.9	24:00:00	368.1	7.2		
02/09/2019	5.93		0.62	0.66	58.75	6.55	2.13	0.02	18.72	9.63	990.8	24:00:00	296.6	16.3		
03/09/2019	5.78		0.64	1.34	52.38	5.88	2.77	0.00	18.50	9.58	995.9	24:00:00	309.3	7.53		
04/09/2019	5.73		0.62	1.73	58.08	6.46	2.72	0.02	18.01	9.60	992.1	22:34:40	229.5	10.63		
05/09/2019	5.88		0.60	0.88	67.19	5.68	1.95	0.00	17.82	9.51	997.7	23:56:00	284.6	8.68		
06/09/2019	5.65		0.63	2.22	66.29	7.14	1.86	0.04	17.72	9.51	1000.2	24:00:00	228.5	20.8		
07/09/2019	5.97		0.66	1.13	64.26	7.69	2.07	0.05	18.84	9.69	1001.0	24:00:00	306.2	7.38		
08/09/2019	5.77		0.66	1.18	66.93	5.99	2.27	0.05	18.37	9.34	1004.8	24:00:00	306.3	6.6		
09/09/2019	5.97		0.68	3.12	65.36	6.34	1.65	0.05	18.18	9.30	998.1	24:00:00	303.0	17.4		
10/09/2019	5.98		0.64	1.26	66.13	7.11	3.77	0.00	18.54	9.41	1000.7	24:00:00	331.6	6.0		
11/09/2019	6.10		0.62	1.91	65.18	6.17	4.27	0.08	18.35	9.61	994.9	24:00:00	336.1	3.4		
12/09/2019	6.47		0.66	1.28	66.41	5.47	3.65	0.05	18.38	9.44	995.0	24:00:00	335.2	9.9		
13/09/2019	5.99		0.67	1.42	65.94	4.66	10.01	0.07	17.99	9.42	999.2	24:00:00	293.3	22.7		
14/09/2019	6.49		0.62	1.69	67.06	6.35	5.29	0.09	18.66	9.41	998.6	24:00:00	325.7	7.74		
15/09/2019	5.88		0.61	1.28	65.33	5.56	3.52	0.06	18.49	9.43	1003.4	24:00:00	325.6	0.0		
16/09/2019	6.39		0.61	1.12	75.69	5.24	2.99	0.02	18.21	9.46	991.1	23:50:10	260.4	0.0		
17/09/2019	6.37		0.69	1.01	69.32	5.85	2.80	0.09	18.45	9.30	999.3	24:00:00	260.4	2.88		
18/09/2019	6.13		0.62	1.10	67.96	7.19	2.98	0.03	17.21	9.80	982.5	23:35:20	260.4	5.8		
19/09/2019	6.13		0.60	1.57	68.49	5.17	2.88	0.01	18.41	9.52	995.9	24:00:00	297.2	15.1		
20/09/2019	6.46		0.62	1.46	72.98	5.52	3.41	0.05	17.68	9.38	982.5	24:00:00	320.4	2.23		
21/09/2019	5.51		0.57	1.46	72.98	5.52	3.41	0.07	17.76	8.62	1013.7	24:00:00	330.4	6.71		
22/09/2019	5.42		0.64	1.17	73.92	4.12	5.13	0.00	17.59	8.44	1016.2	24:00:00	356.9	0.0		
23/09/2019	5.72		0.65	1.24	71.33	5.21	4.03	0.02	18.26	8.87	999.1	24:00:00	345.1	0.0		
24/09/2019	6.23		0.66	1.07	72.55	6.14	3.54	0.05	17.76	8.86	1007.7	24:00:00	339.7	0.06		
25/09/2019	6.98		0.65	1.35	69.28	6.55	4.26	0.07	18.11	9.10	1002.7	24:00:00	296.9	7.8		
26/09/2019	6.82		0.66	1.64	69.34	8.21	6.01	0.09	18.64	9.20	987.1	24:00:00	315.5	8.1		
27/09/2019	7.11		0.66	1.23	67.23	5.91	4.20	0.06	18.06	9.37	989.7	24:00:00	305.5	2.88		
28/09/2019	7.08		0.62	1.10	68.67	7.25	3.81	0.03	18.94	9.15	1009.9	24:00:00	378.4	9.1		
29/09/2019	6.46		0.64	1.10	70.22	7.35	3.55	0.01	18.83	8.90	1007.0	24:00:00	357.2	0.05		
30/09/2019	6.62		0.62	1.21	67.91	7.64	3.56	0.05	18.44	9.00	1005.3	24:00:00	339.2	0.34		
Max	7.58		0.69	3.12	75.69	8.21	10.01	0.09	18.94	9.80	1017.8	24:00:00	378.4	10.63		
Min.	5.42		0.57	0.66	52.38	4.12	1.65	0.00	17.21	8.44	982.5	24:00:00	228.5	0.00		
Dep. VLE jour	0		0	0	0	0	0	0	0	0	0	0	0	0		
Nb Jour Inva.	0		0	0	0	0	0	0	0	0	0	0	0	0		
Dep. VLE Max	00:00		00:00	00:00	00:00	00:00	00:00	00:00	00:00	00:00	00:00	00:00	00:00	00:00		
Dep. Seuil Min.	0		0	0	0	0	0	0	0	0	0	0	0	0		
Moy. Mensuelle	6.22		0.64	1.36	67.17	6.26	3.53	0.04	18.26	9.31	999.8	20:11:56:10	9374.6	321.2		
% données HG	0.00		0.00	0.00	0.00	0.00	0.00	0.00	0.00	0.00	0.00	0.00	0.00	0.00		
% données HC	0.00		0.00	0.00	0.00	0.00	0.00	0.00	0.00	0.00	0.00	0.00	0.00	0.00		
Annuel																

Contraintes réglementaires L2 - 2019 HCL														
Dépassement >4H														
Nb jour invalides														
Indis. Cons >10h														
Indisponibilité														
CO	0		0	0	0	0	0	0	0	0	0	0	0	0
SO2	0		0	0	0	0	0	0	0	0	0	0	0	0
NOx	0		0	0	0	0	0	0	0	0	0	0	0	0
CO2	0		0	0	0	0	0	0	0	0	0	0	0	0
NH3	0		0	0	0	0	0	0	0	0	0	0	0	0
Global	0		0	0	0	0	0	0	0	0	0	0	0	0
Dep. VLE	01:30		14:30	03:00	00:00	04:30	00:30	00:30	00:30	00:30	00:30	00:30	01:30	23:30
Nb jour invalides	1		1	1	1	1	1	1	1	1	1	1	1	1
Indis. Cons >10h	0		0	0	0	0	0	0	0	0	0	0	0	0
Indisponibilité	05:30		05:30	05:30	05:30	05:30	05:30	05:30	05:30	05:30	05:30	05:30	05:30	05:30



Rapport DREAL Mensuel Ligne 2

Rapport Mensuel															Octobre 2019	
Mesure IC 95 Mesopoll L2																
Unité	CO	COT	HCL	NOx	POUSSIÈRE	SO2	NH3	Vitesse	O2	T2S L2	MarchéForL2	Tonnage OM L2	Tonnage DASRL2	Ratio Jour L2		
VLE Jeur	mg/Nm3	mg/Nm3	mg/Nm3	mg/Nm3	mg/Nm3	mg/Nm3	mg/Nm3	m/s	%	degreC	h/mn/ss	Tonnage	Tonnage			
VLE Max	10	20	10	10	150	10	50	10	15		850					
Seuil Min.	20		60		30		200	20								
VLE 1/2h	20															
01/10/2019	6.56		1.53		70.26	8.88	3.64	0.04	18.48	8.76		24:00:00	356.5	5.0		
02/10/2019	6.59		0.91		74.84	4.92	2.26	0.08	18.17	8.59		24:00:00	321.8	4.9		
03/10/2019	5.71		0.56		71.36	5.98	0.86	0.05	17.63	8.63		24:00:00	323.3	5.26		
04/10/2019	5.56		0.50		71.79	4.88	0.67	0.03	17.71	8.45		24:00:00	273.9	4.6		
05/10/2019	6.02		1.33		73.05	4.02	1.95	0.04	17.53	8.36		24:00:00	366.5	0.00		
06/10/2019	5.66		0.54		72.08	5.40	1.49	0.05	18.10	8.49		24:00:00	310.1	0.00		
07/10/2019	5.92		1.39		67.11	5.63	0.90	0.03	17.83	8.40		24:00:00	300.4	3.36		
08/10/2019	6.45		0.93		66.74	6.61	2.29	0.11	18.41	8.91		24:00:00	312.6	10.1		
09/10/2019	5.85		0.88		69.83	5.33	1.51	0.02	17.96	8.50		24:00:00	344.0	3.01		
10/10/2019	5.77		1.12		67.05	5.29	2.17	0.21	17.45	8.94		24:00:00	297.0	13.1		
11/10/2019	6.04		1.42		67.80	5.77	4.38	0.06	17.70	8.78		23:52:00	298.1	15.7		
12/10/2019	5.65		0.58		70.63	4.93	5.12	0.00	17.70	8.39		24:00:00	298.1	26.1		
13/10/2019	5.46		1.43		70.76	5.02	5.86	0.07	17.99	8.43		24:00:00	324.9	5.32		
14/10/2019	5.65		1.05		69.85	4.82	6.11	0.05	17.84	8.60		24:00:00	14.2	4.34		
15/10/2019	5.69		0.83		68.16	7.46	5.81	0.03	18.28	8.83		23:51:40	289.1	16.1		
16/10/2019	5.83		1.03		67.99	3.77	7.46	0.08	16.74	8.77		24:00:00	270.0	7.63		
17/10/2019	6.22		1.00		70.49	5.15	7.32	0.08	18.16	8.77		24:00:00	281.5	8.03		
18/10/2019	6.39		0.72		65.80	8.29	4.00	0.11	18.00	8.95		24:00:00	308.7	10.3		
19/10/2019	6.46		0.85		70.04	8.45	0.56	0.03	18.25	8.80		24:00:00	322.7	5.1		
20/10/2019	6.55		0.80		70.83	6.95	0.56	0.02	18.25	8.80		24:00:00	359.5	1.7		
21/10/2019	6.82		0.88		66.76	6.33	2.16	0.12	18.64	9.19		24:00:00	1022.6	12.2		
23/10/2019	8.27		0.66		65.35	6.97	3.55	0.02	18.37	8.78		24:00:00	428.5	0.28		
24/10/2019	7.81		0.81		64.30	4.43	0.00	0.10	18.64	9.19		24:00:00	363.1	8.8		
25/10/2019	8.07		1.35		61.89	3.89	0.00	0.04	18.34	9.29		24:00:00	299.4	3.6		
26/10/2019	7.54		0.91		70.33	3.89	0.31	0.07	17.59	9.45		24:00:00	299.4	3.6		
27/10/2019	7.52		0.74		67.43	2.93	0.08	0.08	18.39	9.21		24:00:00	318.2	4.8		
28/10/2019	6.86		0.58		66.93	2.69	0.05	0.10	18.41	8.94		24:00:00	327.8	7.3		
29/10/2019	7.08		0.52		63.55	3.29	0.00	0.07	18.23	8.61		24:00:00	378.3	2.3		
30/10/2019	7.52		0.52		63.55	3.29	0.00	0.05	18.04	8.64		24:00:00	322.4	0.9		
31/10/2019	8.11		0.55		64.84	2.21	0.00	0.08	17.98	8.97		23:20:50	340.0	2.91		
Max	8.67		1.53		74.84	8.88	7.32	0.21	18.64	9.32		22:18:00	428.5	24.1		
Min.	5.46		0.34		61.89	2.21	0.00	0.00	16.74	8.36			270.0	0.0		
Dep. VLE Jour	0		0		0	0	0	0	0	0			0	0.00		
Nb Jour Inva.	0		0		0	0	0	0	0	0			0	0		
Dep. VLE Max	00:00		00:00		00:00	00:00	00:00	00:00	00:00	00:00			0	0		
Dep. Seuil Min.	0		0		0	0	0	0	0	0			0	0		
Dep. VLE 1/2h	0		0		0	0	0	0	0	0			0	0		
Moy. Mensuelle	6.59		0.96		68.59	5.23	2.20	0.07	17.97	8.84		10119.0	270.3	270.3		
% données HG	0.00		0.00		0.00	0.00	0.00	0.00	0.00	0.00		0.0	0.0	0.0		
% données HG	0.00		0.00		0.00	0.00	0.00	0.00	0.00	0.00		0.0	0.0	0.0		
Annuel																

Contrôle réglementaire L2 - 2019 HCL														
Dépassement >H														
Dep. VLE	01:30	15:30	03:00	00:00	04:30	00:00	00:30	00:00	01:30	00:00	00:30	00:00	01:30	00:00
Nb jour invalides	1	1	1	1	1	1	1	1	1	1	1	1	1	1
Indis. Cons >10h	0	0	0	0	0	0	0	0	0	0	0	0	0	0
Indisponibilité	05:30	05:30	05:30	05:30	05:30	05:30	05:30	05:30	05:30	05:30	05:30	05:30	05:30	05:30
Global	0	0	0	0	0	0	0	0	0	0	0	0	0	0
Global	0	0	0	0	0	0	0	0	0	0	0	0	0	0

* Le 22/10/2019, dépassement de 2 moyennes 30' en poussières à 58,43 mg/Nm3 et à 37,94mg/Nm3 (pour une limite à 30) suite à des défauts sur les champs de l'électrofiltre.

Rapport DREAL Mensuel Ligne 2

Rapport Mensuel

Mesure IC 95 Mensuel L2		Novembre 2019											
Unité	CO	COT	HCL	NOx	POUSSIÈRE	SO2	NH3	Vitesse	O2	FS L2	MarcheFour.L2	Tonnage OM L2	Tonnage DASRI L2
VLE Jour	mg/Nm3	mg/Nm3	mg/Nm3	mg/Nm3	mg/Nm3	mg/Nm3	mg/Nm3	m/s	%	degreC	heures	Tonne	Tonne
VLE Max	50	100	10	10	10	150	50	18	15	850			
Seuil Min.	100		20	60	30		200	20					
VLE 1/2h	20		160										
01/11/2019	7.34		66.85	0.59	2.67	0.01	0.01	0.16	18.25	8.79	1010.2	24:00:00	305.6
02/11/2019	7.19		66.30	0.92	2.73	0.01	0.01	0.16	18.37	8.81	1005.2	24:00:00	376.0
03/11/2019	7.02		68.02	0.83	2.87	0.00	0.04	0.06	18.02	8.56	1012.3	24:00:00	384.4
04/11/2019	7.74		65.82	0.78	2.45	0.00	0.04	0.04	17.79	8.97	991.9	24:00:00	323.6
05/11/2019	7.61		64.89	0.59	4.89	0.05	0.05	0.10	19.05	9.13	995.3	24:00:00	271.2
06/11/2019	8.34		60.79	0.75	3.76	0.47	0.39	0.12	17.32	9.74	987.2	24:00:00	315.5
07/11/2019	7.76		67.36	0.80	2.56	0.00	0.00	0.13	17.64	8.81	1009.1	24:00:00	357.3
08/11/2019	7.68		70.40	0.46	3.90	0.00	0.00	0.11	18.46	9.10	1010.0	24:00:00	380.6
09/11/2019	7.67		72.78	0.47	3.90	0.00	0.00	0.11	18.46	8.78	1015.3	24:00:00	389.7
10/11/2019	7.61		69.33	0.52	3.21	0.00	0.06	0.07	19.09	9.25	989.9	24:00:00	379.5
11/11/2019	7.11		70.36	0.47	3.21	0.00	0.06	0.07	19.09	9.08	995.8	24:00:00	317.2
12/11/2019	7.25		70.04	0.47	4.14	0.00	0.06	0.06	19.07	9.11	994.0	24:00:00	292.3
13/11/2019	7.15		68.93	0.56	4.21	0.04	0.04	0.07	18.98	9.25	990.7	24:00:00	290.8
14/11/2019	7.45		70.37	0.87	4.79	0.07	0.05	0.09	18.73	9.15	998.4	24:00:00	269.1
15/11/2019	7.36		69.06	0.61	3.09	0.53	0.39	0.09	18.54	9.28	995.3	24:00:00	289.8
16/11/2019	7.54		71.06	0.62	2.97	0.62	0.56	0.09	18.97	8.99	1000.6	24:00:00	303.0
17/11/2019	6.85		64.17	0.56	2.93	0.00	0.09	0.15	19.04	9.15	999.6	24:00:00	346.3
18/11/2019	7.50		64.55	0.61	2.39	0.81	0.81	0.04	18.71	9.19	1008.6	24:00:00	321.6
19/11/2019	7.15		69.64	0.57	3.02	0.02	0.08	0.08	18.79	9.28	1016.8	24:00:00	321.6
20/11/2019	7.63		66.77	0.54	2.91	2.06	2.06	0.04	17.80	9.74	997.8	23:28:30	328.0
21/11/2019	7.56		70.21	0.52	2.69	0.02	0.05	0.05	18.68	9.02	1013.7	24:00:00	337.8
22/11/2019	7.63		68.47	0.59	3.70	0.59	0.90	0.15	18.78	9.41	1009.7	24:00:00	408.8
23/11/2019	7.73		69.20	0.67	3.78	2.64	2.64	0.10	18.90	9.29	1005.6	24:00:00	352.7
24/11/2019	7.57		68.40	0.50	4.23	2.07	2.07	0.07	19.26	9.40	995.5	24:00:00	253.6
25/11/2019	8.71		68.56	0.75	3.56	0.75	0.75	0.07	19.34	9.70	993.3	24:00:00	358.2
26/11/2019	7.99		65.94	1.09	3.84	1.01	1.01	0.06	19.50	9.74	996.5	24:00:00	281.0
27/11/2019	8.80		67.29	1.14	3.09	2.92	2.92	0.06	18.46	9.66	998.9	24:00:00	329.8
28/11/2019	8.31		65.54	1.32	5.06	2.25	2.25	0.05	19.44	9.79	993.8	24:00:00	317.3
29/11/2019	7.83		64.64	1.32	5.65	4.65	4.65	0.12	18.71	9.59	1001.5	22:48:10	397.3
30/11/2019	8.57		70.15	0.51	5.49	1.71	1.71	0.36	19.03	9.35	994.1	24:00:00	347.9
Max	8.80		72.78	1.32	5.65	9.02	9.02	0.36	19.50	9.79	1016.8	488.8	25.6
Min	6.85		60.79	0.46	2.39	0.00	0.04	0.04	17.32	8.56	987.2	253.6	0.0
Nb Jour Inva.	0		0	0	0	0	0	0	0	0	0	0	0
Dep. VLE Max	00:00		00:00	00:00	00:00	00:00	00:00	00:00	00:00	00:00	00:00	0	0
Dep. Seuil Min.													
Dep. VLE 1/2h	0		0	0	0	0	0	2	18.66	9.24	1000.9	25:22:16:40	1009.8
Moy. Mensuelle	7.65		67.87	0.70	3.59	1.71	1.71	0.14	0.00	0.00	0.00	0.0	173.9
% données HG	0.00		0.00	0.00	0.00	0.00	0.00	0.00	0.00	0.00	0.00	0.0	0.0
% données HG Annuel	0.00		0.00	0.00	0.00	0.00	0.00	0.00	0.00	0.00	0.00	0.0	0.0

Contrôle réglementaire L2 - 2019		CO				SO2				NOx				NH3				COT				Global												
Dépassement >4H		Dép. VLE		Nb jour invalides		Indis. Cons >10h		Indisponibilité		Dép. VLE		Nb jour invalides		Indis. Cons >10h		Indisponibilité		Dép. VLE		Nb jour invalides		Indis. Cons >10h		Indisponibilité		Dép. VLE		Nb jour invalides		Indis. Cons >10h		Indisponibilité		
01:30	0	0	0	0	0	0	0	0	0	0	0	0	0	0	0	0	0	0	0	0	0	0	0	0	0	0	0	0	0	0	0	0		
05:30	1	15:30	1	03:00	1	00:00	04:30	1	00:30	0	00:30	0	00:30	1	00:30	0	00:30	0	00:30	0	00:30	0	00:30	0	00:30	0	00:30	0	00:30	0	00:30	0	00:30	
05:30	0	05:30	0	05:30	0	05:30	0	05:30	0	05:30	0	05:30	0	05:30	0	05:30	0	05:30	0	05:30	0	05:30	0	05:30	0	05:30	0	05:30	0	05:30	0	05:30	0	05:30

* Le 30/11/2019, dépassement de 2 moyennes 30' en NH3 à 50.83 et 20.54 mg/Nm3 (pour une limite à 20) suite à une mise en sécurité du TF.

04/12/2018 12:23 Page 1

Rapport DREAL Mensuel Ligne 2

Rapport Mensuel

Mesure IC 95 Mensuel L2

Decembre 2019

Unité	CO	COT	HCL	NOx	POUSSIERE	SO2	NH3	Vitesse	O2	TSS L2	Marché-Pour-L2	Tonnage-OM L2	Tonnage-DASRI L2	Ratio Jour L2
VLE Jour	50	100	10	10	10	150	50	10	%	degreC	kg/mm.s	Tonne	Tonne	-
VLE Max	100		20					10						
Seuil Min.	100		20	60	160	30	200	20	15		850			
01/12/2019	8.33		0.51	0.53	66.76	3.81	1.48	0.10	19.56	9.59	994.9	24.00.00	453.2	0.0
02/12/2019	8.21		0.54	0.49	65.68	3.71	1.72	0.06	19.32	9.60	996.3	24.00.00	319.4	0.0
03/12/2019	7.78		0.57	0.55	64.27	4.45	1.15	0.05	19.25	9.53	1001.0	24.00.00	315.9	1.47
04/12/2019	8.38		0.60	0.61	62.46	5.37	5.49	0.08	19.47	9.64	991.9	24.00.00	322.5	2.25
05/12/2019	8.54		0.64	0.50	60.54	3.81	1.62	0.04	19.60	9.78	990.4	24.00.00	307.9	3.2
06/12/2019	8.22		0.61	0.48	61.65	3.89	7.12	0.06	19.44	9.68	994.9	24.00.00	342.3	4.5
07/12/2019	8.12		0.57	0.65	62.70	4.64	4.59	0.09	19.99	9.48	988.3	24.00.00	326.2	0.79
08/12/2019	8.50		0.56	1.06	61.90	4.15	6.57	0.09	19.92	9.57	985.1	24.00.00	358.9	0.0
09/12/2019	9.47		0.57	0.64	60.09	3.93	3.19	0.06	19.61	9.55	982.1	24.00.00	332.8	0.0
10/12/2019	7.79		0.58	0.90	61.63	3.93	0.90	0.08	19.56	9.72	976.5	24.00.00	289.8	0.1
11/12/2019	7.95		0.57	0.67	62.67	3.89	2.93	0.07	19.59	9.30	985.5	24.00.00	396.8	6.3
12/12/2019	8.56		0.56	0.60	62.66	3.79	0.03	0.08	19.51	9.30	985.5	24.00.00	396.8	5.2
13/12/2019	8.56		0.55	0.61	62.79	3.61	0.44	0.07	19.51	9.30	985.5	24.00.00	396.8	5.2
14/12/2019	8.24		0.55	0.69	70.89	5.39	0.04	0.09	19.35	9.37	998.3	23.59.30	998.3	11.3
15/12/2019	7.68		0.53	0.74	75.04	3.73	0.03	0.06	19.92	9.36	1002.3	24.00.00	396.4	10.5
16/12/2019	8.14		0.58	0.69	66.51	4.37	0.03	0.15	19.85	9.21	1005.2	24.00.00	368.9	2.3
17/12/2019	7.56		0.52	1.13	63.55	3.86	0.08	0.10	19.61	9.49	991.1	24.00.00	335.5	0.8
18/12/2019	7.86		0.56	0.72	78.6	3.01	0.07	0.06	19.34	9.62	996.4	24.00.00	236.9	5.0
19/12/2019	7.25		0.49	1.29	66.42	2.65	3.03	0.05	18.64	9.00	1020.0	24.00.00	342.8	7.2
20/12/2019	8.99		0.55	0.98	62.46	3.56	0.14	0.08	19.15	9.66	1005.9	24.00.00	368.3	10.9
21/12/2019	8.66		0.57	0.74	63.45	3.80	1.27	0.12	19.34	9.36	1005.9	24.00.00	407.9	15.8
22/12/2019	8.05		0.57	0.77	62.71	3.64	0.00	0.06	19.57	9.44	999.7	24.00.00	499.3	0.0
23/12/2019	9.00		0.63	0.70	62.50	2.99	0.01	0.10	19.17	9.65	985.7	24.00.00	424.1	0.0
24/12/2019	7.42		0.60	0.55	64.15	2.25	0.00	0.07	18.82	9.18	985.9	24.00.00	303.9	0.5
25/12/2019	7.75		0.64	0.49	63.84	2.66	0.01	0.08	18.87	9.24	1003.4	24.00.00	478.7	1.6
26/12/2019	8.21		0.60	0.55	62.26	3.25	0.09	0.06	19.14	9.59	992.0	24.00.00	431.2	0.0
27/12/2019	8.01		0.60	0.46	62.71	3.66	0.00	0.10	19.33	9.47	990.2	24.00.00	422.3	0.1
28/12/2019	7.43		0.58	0.51	63.32	2.69	0.01	0.07	19.19	9.34	995.4	24.00.00	312.1	0.0
29/12/2019	7.66		0.61	0.59	63.36	2.28	0.73	0.16	18.75	9.20	989.9	24.00.00	281.5	0.0
30/12/2019	9.36		0.61	0.48	62.30	3.06	5.56	0.79	17.95	9.23	1008.9	23.49.20	265.9	0.0
31/12/2019	9.47		0.64	1.29	75.04	5.54	7.12	0.79	19.99	9.78	1020.0	23.49.20	234.3	0.0
Max.	9.47		0.64	1.29	75.04	5.54	7.12	0.79	19.99	9.78	1020.0	23.49.20	234.3	0.0
Min.	7.25		0.49	0.46	60.99	2.25	0.00	0.04	17.95	9.00	976.5	23.49.20	234.3	0.0
Dep. VLE Jour	0		0	0	0	0	0	0	0	0	0	0	0	0
Nb Jour Inva.	0		0	0	0	0	0	0	0	0	0	0	0	0
Dep. VLE Max	00:00		00:00	00:00	00:00	00:00	00:00	00:00	00:00	00:00	00:00	00:00	00:00	00:00
Dep. Seuil Min.														
Dep. VLE 1/2h	0		0	0	3	0	0	1	00:00	90:00	00:00	00:00	00:00	00:00
Moy. Mensuelle	8.16		0.57	0.63	63.92	3.71	1.57	0.13	19.35	9.47	994.7	30j 23:40:50	10872.9	123.6
% données HG	0.00		0.00	0.00	0.00	0.00	0.00	0.00	0.00	0.00	0.00	0.00	0.00	0.00
% données HC	0.00		0.00	0.00	0.00	0.00	0.00	0.00	0.00	0.00	0.00	0.00	0.00	0.00
Annuel														

Contrôle réglementaire L2 - 2019 HCL									
CO	POUSSIERE	SO2	NOx	COT	NH3	Global			
0	0	0	0	0	0	0			
01:30	15:30	03:00	00:00	06:00	00:30	03:00			
1	1	1	1	1	1	1			
Indis. Cons > 10h	0	0	0	0	0	0			
Indisponibilité	05:30	05:30	05:30	05:30	05:30	06:30			

* Le 09/12/2019, dépassement d'une moyenne 30' en NOx à 200.68 mg/Nm3 (pour une limite à 160) suite à une mise en sécurité du TF.
 * Le 31/12/2019, - dépassement d'une moyenne 30' en NH3 à 35.04 mg/Nm3 (pour une limite à 20) suite à une mise en sécurité du TF;
 - dépassement de deux moyennes 30 min en NOx à 169.25 et 163.95 mg/Nm3 (pour une limite à 160) suite à une mise en sécurité du TF

Date	Du 25/12/2018 au 23/01/2019	Du 23/01/2019 au 19/02/2019	Du 19/02/2019 au 19/03/2019	Du 19/03/2019 au 16/04/2019	Du 16/04/2019 au 14/05/2019	Du 14/05/2019 au 09/07/2019	Du 09/07/2019 au 06/09/2019	Du 06/09/2019 au 03/09/2019	Du 03/09/2019 au 01/10/2019	Du 01/10/2019 au 29/10/2019	Du 29/10/2019 au 26/11/2019	Du 26/11/2019 au 23/12/2019
Prélèvement	AMESA	AMESA	AMESA	AMESA	AMESA	AMESA	AMESA	AMESA	AMESA	AMESA	AMESA	AMESA
Analyse	Dioxlab	Dioxlab	Dioxlab	Dioxlab	Dioxlab	Dioxlab	Dioxlab	Dioxlab	Dioxlab	Dioxlab	Dioxlab	Dioxlab
Données générales												
Durée de la période	s	3,97470	3,99661	4,00050	3,99663	4,00179	3,99167	4,00635	3,99683	3,99276	4,00099	3,95030
Durée de prélèvement	h	471,52	651,27	633,70	620,97	143,37	546,27	611,83	589,10	664,62	663,82	643,43
Durée de fonctionnement de l'installation	h	661,3	651,3	647,6	624,2	144,1	657,0	636,4	601,4	670,5	669,3	645,6
Indisponibilité du système de prélèvement	%	28,7%	0,0%	2%	0,5%	0,5%	16,9%	3,9%	2,1%	0,9%	0,8%	0,3%
Indisponibilité du système de prélèvement depuis début d'analyse	%	28,7%	14,5%	7,7%	6,4%	6,1%	7,8%	7,3%	6,7%	5,5%	5,1%	4,7%
Volume des fumées rejetées sur la période de prélèvement	Nm ³ sec	36 407 717	48 342 601	46 928 193	46 946 652	10 636 954	37 952 693	41 493 714	40 055 032	44 931 709	46 325 492	47 429 882
Débit horaire moyen des fumées rejetées sur la période de prélèvement	Nm ³ sechh	55056	74227	72467	75217	73834	57765	65204	66599	67012	69217	73463
Volume prélevé	Nm ³ sec	308,715	412,379	401,312	405,835	90,640	327,675	356,843	342,722	387,714	397,646	406,601
Débit prélèvement sur sec	Nm ³ sechh	0,65	0,63	0,63	0,65	0,63	0,00	0,58	0,58	0,58	0,60	0,63
O ₂	%	9,90	9,50	9,80	9,80	10,00	9,40	9,10	9,40	8,80	9,20	9,50
H ₂ O	g/m3	2013,00	212,00	198,00	203,00	208,00	209,00	217,00	211,00	227,00	229,00	214,00
Ratio volume rejeté/prélevé		117933,10	117228,57	116936,93	115679,16	117353,66	0,00	116290,03	116873,24	115888,80	116499,33	116649,69
Ratio volume/durée prélèvement	m3/h	0,65	0,63	0,63	0,65	0,63	0,00	0,58	0,58	0,58	0,60	0,63
Teneur en PCDD/F @11% O₂ sur gaz sec												
Teneur en PCDD/F sur brut	ng/Nm ³	0,723	0,450	0,371	0,836	0,444	0,260	0,151	0,161	0,182	0,126	0,316
Teneur en PCDD/F en I-TEQ	ng _{I-TEQ} /Nm ³	0,047	0,030	0,026	0,059	0,024	0,010	0,007	0,008	0,009	0,007	0,019
Flux de PCDD/F												
Flux de PCDD/F en I-TEQ	mg	1,729	1,450	1,205	2,755	0,256	0,386	0,297	0,306	0,408	0,339	0,889
Flux de PCDD/F en I-TEQ cumulé	mg	1,729	3,179	6,550	9,305	9,561	9,947	10,243	10,549	11,237	11,577	12,466

Commentaires:

The first part of the document discusses the importance of maintaining accurate records of all transactions. It emphasizes that every entry should be supported by a valid receipt or invoice. This not only helps in tracking expenses but also ensures compliance with tax regulations.

In the second section, the author provides a detailed breakdown of the company's revenue streams. This includes sales from various product lines and services. The data shows a steady increase in revenue over the past year, which is attributed to improved marketing strategies and operational efficiency.

The third section focuses on the company's financial health. It highlights the strong cash flow and the ability to meet all financial obligations. The author notes that the company's debt-to-equity ratio remains low, indicating a solid financial foundation.

Finally, the document concludes with a summary of the overall performance and a look ahead at future goals. The author expresses confidence in the company's ability to continue its growth trajectory in the coming year.

3.3. Ligne spécifique DAS

3.3.1. Mesure en continu des flux de polluants

3.3.2. Mesure en continu des concentrations en polluants

3.3.3. Mesure en semi continu des dioxines et furanes



Rapport DREAL Flux Mensuel Ligne 4

Rapport Flux Mensuel											Janvier 2019	
FLUX Ligne 4												
CO_30_FLUX_L4	COT_FLUX_L4	HCL_FLUX_L4	NOX_FLUX_L4	POUSS_FLUX_L4	SO2_FLUX_L4	NH3_FLUX_L4	MarcheFour14_30					
Unité Kg	Kg	Kg	Kg	Kg	Kg	Kg	hh:mm:ss					
VLE Jour	23.25	5.85	5.85	58.5	4.69	17.55	5.85					
01/01/2019	6.84	0.05	3.50	24.06	0.42	0.84	0.44	16:21:00				
02/01/2019	3.43	0.00	3.30	27.25	0.54	1.09	0.40	23:58:50				
03/01/2019	3.33	0.00	2.76	24.11	0.46	0.92	0.42	18:49:30				
04/01/2019	4.11	0.00	3.66	29.61	0.57	1.16	0.42	23:55:10				
05/01/2019	1.11	0.00	4.10	31.57	0.57	1.17	0.45	23:59:50				
06/01/2019	0.03	0.00	0.22	1.59	0.03	0.07	0.02	01:20:50				
07/01/2019	2.98	0.01	2.61	20.11	0.32	0.64	0.15	14:15:50				
08/01/2019	6.97	0.00	3.32	31.51	0.65	1.21	0.27	22:54:20				
09/01/2019	5.85	0.00	3.45	33.78	0.57	1.13	0.34	22:55:10				
10/01/2019	2.28	0.00	4.00	42.35	0.60	1.18	0.34	22:59:10				
11/01/2019	0.62	0.00	4.05	41.20	0.57	1.14	0.31	23:31:00				
12/01/2019	2.79	0.01	4.12	35.18	0.56	1.11	0.37	22:37:20				
13/01/2019	2.41	0.01	2.45	27.26	0.40	0.87	0.27	18:20:40				
14/01/2019	5.21	0.01	2.35	24.66	0.36	0.76	0.23	16:03:10				
15/01/2019	1.38	0.00	3.95	41.28	0.55	1.09	0.34	23:25:10				
16/01/2019	2.78	0.00	4.36	35.19	0.58	1.18	0.52	22:55:10				
17/01/2019	0.92	0.00	3.94	39.16	0.58	1.20	0.46	23:11:10				
18/01/2019	1.14	0.00	2.65	23.40	0.42	0.82	0.32	16:11:10				
19/01/2019	Arrêt	Arrêt	Arrêt	Arrêt	Arrêt	Arrêt	Arrêt	00:00:00				
20/01/2019	Arrêt	Arrêt	Arrêt	Arrêt	Arrêt	Arrêt	Arrêt	00:00:00				
21/01/2019	Arrêt	Arrêt	Arrêt	Arrêt	Arrêt	Arrêt	Arrêt	00:00:00				
22/01/2019	Arrêt	Arrêt	Arrêt	Arrêt	Arrêt	Arrêt	Arrêt	00:00:00				
23/01/2019	Arrêt	Arrêt	Arrêt	Arrêt	Arrêt	Arrêt	Arrêt	00:00:00				
24/01/2019	Arrêt	Arrêt	Arrêt	Arrêt	Arrêt	Arrêt	Arrêt	00:00:00				
25/01/2019	Arrêt	Arrêt	Arrêt	Arrêt	Arrêt	Arrêt	Arrêt	00:00:00				
26/01/2019	Arrêt	Arrêt	Arrêt	Arrêt	Arrêt	Arrêt	Arrêt	00:00:00				
27/01/2019	Arrêt	Arrêt	Arrêt	Arrêt	Arrêt	Arrêt	Arrêt	00:00:00				
28/01/2019	Arrêt	Arrêt	Arrêt	Arrêt	Arrêt	Arrêt	Arrêt	00:00:00				
29/01/2019	0.95	0.00	0.89	9.82	0.23	0.37	0.16	07:16:10				
30/01/2019	5.40	0.00	4.07	49.30	0.72	1.25	0.49	23:17:40				
31/01/2019	7.86	0.00	4.86	38.31	0.76	1.43	0.92	23:11:00				
Min	0.03	0.00	0.22	1.59	0.03	0.07	0.02					
Max	7.86	0.05	4.86	49.30	0.76	1.43	0.92					
Cumul	68.39	0.09	68.61	630.70	10.46	20.63	7.64	17j 03:29:20				
VLE Flux Jour	0	0	0	0	0	0	0					



Rapport DREAL Flux Mensuel Ligne 4

Rapport Flux Mensuel												Février 2019	
FLUX Ligne 4													
Unité Kg	CO ₂ _FLUX_L4	COF_FLUX_L4	HCL_FLUX_L4	NOX_FLUX_L4	POUSS_FLUX_L4	SO2_FLUX_L4	NH3_FLUX_L4	MarcheFourL4_30					
VLE Jour	23.25	5.85	5.85	5.85	58.5	4.69	17.55	hh.mm.ss					
01/02/2019	5.82	0.00	4.63	4.63	37.44	0.80	1.40	0.90	23:53:00				
02/02/2019	4.96	0.00	5.13	5.13	38.70	0.70	1.38	0.74	23:52:00				
03/02/2019	13.42	0.00	4.37	4.37	36.74	0.66	1.38	0.97	22:17:30				
04/02/2019	10.90	0.01	4.43	4.43	36.31	0.72	1.41	1.00	23:57:40				
05/02/2019	4.34	0.00	4.62	4.62	38.83	0.71	1.39	0.77	23:55:50				
06/02/2019	3.58	0.00	4.67	4.67	39.86	0.66	1.34	0.73	23:49:20				
07/02/2019	1.78	0.00	4.30	4.30	38.23	0.68	1.39	0.73	23:47:10				
08/02/2019	0.87	0.00	4.39	4.39	35.92	0.67	1.31	0.75	23:26:20				
09/02/2019	3.06	0.00	4.61	4.61	35.88	0.63	1.34	0.61	23:19:20				
10/02/2019	2.72	0.00	4.28	4.28	38.07	0.66	1.39	0.63	24:00:00				
11/02/2019	1.41	0.00	4.24	4.24	35.29	0.66	1.34	0.50	24:00:00				
12/02/2019	1.52	0.00	3.86	3.86	36.35	0.70	1.39	0.54	23:57:30				
13/02/2019	4.94	0.00	3.97	3.97	39.27	0.72	1.45	0.63	24:00:00				
14/02/2019	0.25	0.00	0.28	0.28	2.50	0.05	0.10	0.05	01:33:00				
15/02/2019	1.87	0.00	0.44	0.44	6.59	0.10	0.30	0.05	06:12:50				
16/02/2019	3.51	0.01	2.95	2.95	32.98	0.45	0.99	0.36	22:01:00				
17/02/2019	1.94	0.00	2.87	2.87	34.45	0.48	1.24	0.35	23:39:40				
18/02/2019	1.47	0.00	3.05	3.05	30.80	0.59	1.42	0.54	23:58:40				
19/02/2019	2.40	0.00	3.44	3.44	28.59	0.54	1.17	0.49	23:28:50				
20/02/2019	1.94	0.00	3.16	3.16	27.70	0.52	1.12	0.42	23:36:10				
21/02/2019	2.58	0.00	3.17	3.17	29.57	0.49	1.09	0.47	23:54:00				
22/02/2019	2.02	0.00	2.87	2.87	29.04	0.54	1.20	0.59	24:00:00				
23/02/2019	0.96	0.00	3.64	3.64	35.83	0.52	1.20	0.46	24:00:00				
24/02/2019	1.01	0.00	3.34	3.34	36.96	0.53	1.18	0.57	23:40:20				
25/02/2019	0.77	0.00	0.66	0.66	8.03	0.11	0.24	0.09	05:07:00				
26/02/2019	5.76	0.04	3.17	3.17	39.27	0.52	2.10	0.45	23:36:20				
27/02/2019	5.09	0.00	3.33	3.33	33.62	0.53	2.14	0.42	23:06:30				
28/02/2019	4.16	0.00	3.85	3.85	39.00	0.58	2.49	0.51	23:59:40				
Min	0.25	0.00	0.28	0.28	2.50	0.05	0.10	0.05					
Max	13.42	0.04	5.13	5.13	39.86	0.80	2.49	1.00					
Cumul	95.05	0.06	97.72	97.72	901.82	15.52	35.89	15.32	25] 04:09:40				
VLE Flux Jour	0	0	0	0	0	0	0	0	0				



Rapport DREAL Flux Mensuel Ligne 4

Rapport Flux Mensuel												Mars 2019	
FLUX Ligne 4													
Unité	CO_30_FLUX_L4	COT_FLUX_L4	HCL_FLUX_L4	NOX_FLUX_L4	POUSS_FLUX_L4	SO2_FLUX_L4	NH3_FLUX_L4	MarcheFournL4_30					
VLE Jour	Kg	Kg	Kg	Kg	Kg	Kg	Kg	hh	mm:ss				
	23.25	5.85	5.85	5.85	58.5	4.69	17.55	5.85					
01/03/2019	2.46	0.00	4.10	4.10	44.61	0.57	2.37	23:50:00	0.37				
02/03/2019	5.04	0.03	4.14	4.14	35.63	0.55	2.00	23:58:50	0.36				
03/03/2019	4.21	0.01	2.78	2.78	30.95	0.39	1.59	17:56:30	0.27				
04/03/2019	2.72	0.00	2.51	2.51	24.26	0.41	1.74	19:17:30	0.32				
05/03/2019	4.70	0.01	4.12	4.12	33.14	0.54	2.02	23:41:50	0.42				
06/03/2019	5.45	0.06	3.74	3.74	32.42	0.56	1.60	23:57:40	0.57				
07/03/2019	6.81	0.07	2.58	2.58	23.30	0.45	1.28	20:32:40	0.45				
08/03/2019	4.49	0.04	3.59	3.59	35.37	0.58	1.81	23:54:40	0.57				
09/03/2019	4.49	0.06	3.32	3.32	36.24	0.55	1.72	23:34:50	0.47				
10/03/2019	3.35	0.02	2.49	2.49	21.78	0.34	1.37	16:39:30	0.28				
11/03/2019	Arrêt	Arrêt	Arrêt	Arrêt	Arrêt	Arrêt	Arrêt	00:00:00	Arrêt				
12/03/2019	Arrêt	Arrêt	Arrêt	Arrêt	Arrêt	Arrêt	Arrêt	00:00:00	Arrêt				
13/03/2019	10.40	0.10	1.17	1.17	19.32	0.35	0.82	14:28:10	0.33				
14/03/2019	6.91	0.06	2.94	2.94	29.89	0.52	1.79	22:13:40	0.37				
15/03/2019	5.54	0.06	3.21	3.21	38.08	0.54	1.61	23:10:20	0.45				
16/03/2019	6.38	0.08	3.76	3.76	40.46	0.56	1.49	23:50:30	0.41				
17/03/2019	6.49	0.06	3.37	3.37	36.85	0.57	1.83	23:27:20	0.38				
18/03/2019	4.25	0.05	3.18	3.18	36.19	0.61	2.10	23:28:50	0.37				
19/03/2019	3.31	0.02	3.21	3.21	31.61	0.51	1.48	21:31:50	0.33				
20/03/2019	1.64	0.01	2.72	2.72	26.46	0.41	1.43	17:38:30	0.23				
21/03/2019	3.08	0.02	3.35	3.35	39.40	0.57	1.53	23:04:40	0.33				
22/03/2019	1.55	0.06	4.02	4.02	51.35	0.57	1.92	23:36:30	0.29				
23/03/2019	2.41	0.03	2.92	2.92	22.90	0.37	0.80	14:06:40	0.19				
24/03/2019	4.67	0.03	2.38	2.38	32.27	0.57	1.36	23:04:40	0.39				
25/03/2019	2.78	0.04	3.09	3.09	33.96	0.64	1.68	23:51:40	0.45				
26/03/2019	2.47	0.03	3.85	3.85	30.61	0.57	1.45	23:29:30	0.32				
27/03/2019	2.90	0.03	3.61	3.61	32.09	0.58	1.32	23:53:50	0.30				
28/03/2019	6.72	0.08	3.61	3.61	32.09	0.61	1.25	23:45:00	0.46				
29/03/2019	1.40	0.01	3.47	3.47	34.70	0.58	1.21	24:00:00	0.40				
30/03/2019	1.57	0.08	3.63	3.63	30.30	0.56	1.18	23:56:20	0.30				
31/03/2019	0.34	0.03	2.84	2.84	25.27	0.35	0.89	16:05:30	0.14				
Min	0.34	0.00	1.17	1.17	19.32	0.34	0.80	0.14	0.14				
Max	10.40	0.10	4.14	4.14	51.35	0.64	2.37	0.57	0.57				
Cumul	118.53	1.18	94.06	94.06	941.55	14.98	44.64	10.52	10.52	26j 06:07:30			
VLE Flux Jour	0	0	0	0	0	0	0	0	0				



Rapport DREAL Flux Mensuel Ligne 4

Rapport Flux Mensuel											Avril 2019
FLUX Ligne 4											
Unité Kg	CO ₂ _30_FLUX_L4	COT_FLUX_L4	HCL_FLUX_L4	NOX_FLUX_L4	POUSS_FLUX_L4	SO ₂ _FLUX_L4	NH ₃ _FLUX_L4	MarcheFourL4_30			
VLE Jour	23.25	5.85	5.85	5.85	58.5	4.69	17.55	hh:mm:ss	5.85		
01/04/2019	1.86	0.02	2.34	2.34	19.11	0.39	1.62	0.23	16:55:30		
02/04/2019	2.72	0.05	3.88	3.88	26.78	0.54	1.70	0.30	23:44:50		
03/04/2019	3.71	0.09	3.31	3.31	30.33	0.59	1.79	0.31	23:57:40		
04/04/2019	2.77	0.24	3.72	3.72	34.75	0.46	2.95	0.23	23:11:40		
05/04/2019	1.53	0.00	3.64	3.64	38.91	0.45	1.89	0.24	23:03:30		
06/04/2019	0.94	0.01	3.64	3.64	42.91	0.52	2.57	0.24	23:52:10		
07/04/2019	0.82	0.09	3.73	3.73	45.42	0.56	3.97	0.18	24:00:00		
08/04/2019	2.52	0.05	2.24	2.24	27.99	0.43	1.51	0.22	19:14:20		
09/04/2019	2.66	0.01	3.49	3.49	32.70	2.60	2.48	0.25	23:54:30		
10/04/2019	3.18	0.01	3.94	3.94	38.78	0.58	2.49	0.29	23:56:30		
11/04/2019	1.70	0.00	3.38	3.38	34.80	0.53	2.41	0.24	20:44:50		
12/04/2019	1.48	0.00	4.02	4.02	35.96	0.52	2.18	0.22	23:20:10		
13/04/2019	0.87	0.00	3.78	3.78	31.87	0.48	1.58	0.20	22:08:20		
14/04/2019	2.97	0.01	1.95	1.95	19.73	0.34	1.33	0.18	15:16:00		
15/04/2019	Arrêt	Arrêt	Arrêt	Arrêt	Arrêt	Arrêt	Arrêt	Arrêt	00:00:00		
16/04/2019	Arrêt	Arrêt	Arrêt	Arrêt	Arrêt	Arrêt	Arrêt	Arrêt	00:00:00		
17/04/2019	Arrêt	Arrêt	Arrêt	Arrêt	Arrêt	Arrêt	Arrêt	Arrêt	00:00:00		
18/04/2019	Arrêt	Arrêt	Arrêt	Arrêt	Arrêt	Arrêt	Arrêt	Arrêt	00:00:00		
19/04/2019	Arrêt	Arrêt	Arrêt	Arrêt	Arrêt	Arrêt	Arrêt	Arrêt	00:00:00		
20/04/2019	Arrêt	Arrêt	Arrêt	Arrêt	Arrêt	Arrêt	Arrêt	Arrêt	00:00:00		
21/04/2019	Arrêt	Arrêt	Arrêt	Arrêt	Arrêt	Arrêt	Arrêt	Arrêt	00:00:00		
22/04/2019	Arrêt	Arrêt	Arrêt	Arrêt	Arrêt	Arrêt	Arrêt	Arrêt	00:00:00		
23/04/2019	Arrêt	Arrêt	Arrêt	Arrêt	Arrêt	Arrêt	Arrêt	Arrêt	00:00:00		
24/04/2019	Arrêt	Arrêt	Arrêt	Arrêt	Arrêt	Arrêt	Arrêt	Arrêt	00:00:00		
25/04/2019	Arrêt	Arrêt	Arrêt	Arrêt	Arrêt	Arrêt	Arrêt	Arrêt	00:00:00		
26/04/2019	Arrêt	Arrêt	Arrêt	Arrêt	Arrêt	Arrêt	Arrêt	Arrêt	00:00:00		
27/04/2019	Arrêt	Arrêt	Arrêt	Arrêt	Arrêt	Arrêt	Arrêt	Arrêt	00:00:00		
28/04/2019	Arrêt	Arrêt	Arrêt	Arrêt	Arrêt	Arrêt	Arrêt	Arrêt	00:00:00		
29/04/2019	Arrêt	Arrêt	Arrêt	Arrêt	Arrêt	Arrêt	Arrêt	Arrêt	00:00:00		
30/04/2019	Arrêt	Arrêt	Arrêt	Arrêt	Arrêt	Arrêt	Arrêt	Arrêt	00:00:00		
Min	0.82	0.00	1.95	1.95	19.11	0.34	1.33	0.18			
Max	3.71	0.24	4.02	4.02	45.42	2.60	3.97	0.31			
Cumul	29.73	0.58	47.06	47.06	460.04	8.99	30.47	3.33		12j 19:20:00	
VLE Flux Jour	0	0	0	0	0	0	0	0			



Rapport DREAL Flux Mensuel Ligne 4

Rapport Flux Mensuel											Mai 2019	
FLUX Ligne 4												
Unité	CO ₂ _FLUX_L4	CO ₁ _FLUX_L4	HCL_FLUX_L4	NOX_FLUX_L4	POUSS_FLUX_L4	SO ₂ _FLUX_L4	NH ₃ _FLUX_L4	MarchefourL4_30				
VLE Jour	Kg	Kg	Kg	Kg	Kg	Kg	Kg	hh	mm:ss			
	23.25	5.85	5.85	5.85	58.5	4.69	17.55	5.85				
01/05/2019	Arrêt	Arrêt	Arrêt	Arrêt	Arrêt	Arrêt	Arrêt	Arrêt	Arrêt	00:00:00		
02/05/2019	Arrêt	Arrêt	Arrêt	Arrêt	Arrêt	Arrêt	Arrêt	Arrêt	Arrêt	00:00:00		
03/05/2019	Arrêt	Arrêt	Arrêt	Arrêt	Arrêt	Arrêt	Arrêt	Arrêt	Arrêt	00:00:00		
04/05/2019	Arrêt	Arrêt	Arrêt	Arrêt	Arrêt	Arrêt	Arrêt	Arrêt	Arrêt	00:00:00		
05/05/2019	Arrêt	Arrêt	Arrêt	Arrêt	Arrêt	Arrêt	Arrêt	Arrêt	Arrêt	00:00:00		
06/05/2019	Arrêt	Arrêt	Arrêt	Arrêt	Arrêt	Arrêt	Arrêt	Arrêt	Arrêt	00:00:00		
07/05/2019	1.75	0.04	0.63	0.63	7.91	0.10	0.50	0.12	Arrêt	00:00:00		
08/05/2019	4.23	0.05	4.22	4.22	33.66	0.63	1.37	0.86	0.86	05:00:50		
09/05/2019	2.04	0.01	2.45	2.45	23.51	0.38	1.32	0.41	0.41	23:41:50		
10/05/2019	2.72	0.00	4.52	4.52	41.10	0.60	2.06	0.68	0.68	17:34:10		
11/05/2019	1.73	0.00	3.31	3.31	42.06	0.53	1.62	0.51	0.51	23:46:10		
12/05/2019	1.64	0.00	3.31	3.31	34.74	0.48	1.36	0.40	0.40	21:24:10		
13/05/2019	3.13	0.01	1.97	1.97	19.45	0.28	2.53	0.23	0.23	18:31:10		
14/05/2019	1.55	0.04	3.85	3.85	41.11	0.48	1.63	0.36	0.36	13:02:40		
15/05/2019	0.49	0.00	4.37	4.37	48.44	0.52	1.58	0.32	0.32	21:06:50		
16/05/2019	1.92	0.00	4.14	4.14	35.28	0.54	1.61	0.31	0.31	23:39:10		
17/05/2019	1.18	0.00	3.51	3.51	41.46	0.58	1.50	0.41	0.41	23:19:40		
18/05/2019	1.94	0.00	3.77	3.77	38.61	0.53	1.57	0.31	0.31	23:37:10		
19/05/2019	1.93	0.00	3.73	3.73	37.75	0.54	1.87	0.31	0.31	23:19:40		
20/05/2019	4.64	0.01	3.20	3.20	27.81	0.38	1.24	0.26	0.26	23:42:50		
21/05/2019	0.65	0.00	3.76	3.76	44.74	0.53	1.72	0.30	0.30	18:33:00		
22/05/2019	1.48	0.03	3.84	3.84	41.52	0.57	1.72	0.28	0.28	22:52:00		
23/05/2019	0.88	0.00	4.58	4.58	37.20	0.59	1.74	0.27	0.27	23:25:30		
24/05/2019	0.60	0.00	4.10	4.10	42.44	0.57	1.53	0.29	0.29	24:00:00		
25/05/2019	4.47	0.04	4.67	4.67	46.29	0.62	1.65	0.35	0.35	23:34:00		
26/05/2019	0.32	0.00	3.31	3.31	34.28	0.42	1.67	0.21	0.21	23:58:10		
27/05/2019	2.30	0.00	2.35	2.35	21.41	0.37	1.09	0.15	0.15	17:40:20		
28/05/2019	1.39	0.00	4.61	4.61	33.77	0.57	1.70	0.25	0.25	16:08:30		
29/05/2019	0.62	0.00	4.63	4.63	50.02	0.57	1.51	0.17	0.17	23:52:20		
30/05/2019	2.39	0.00	3.65	3.65	35.78	0.55	1.22	0.28	0.28	23:58:40		
31/05/2019	3.17	0.03	2.14	2.14	21.67	0.34	0.81	0.17	0.17	22:42:00		
										14:12:10		
Min	0.32	0.00	0.63	0.63	7.91	0.10	0.50	0.12	0.12			
Max	4.64	0.05	4.67	4.67	50.02	0.63	2.53	0.86	0.86			
Cumul	49.16	0.26	88.62	88.62	882.01	12.27	38.12	8.22	8.22	21j 12:51:30		
VLE Flux Jour	0	0	0	0	0	0	0	0	0			



Rapport DREAL Flux Mensuel Ligne 4

Rapport Flux Mensuel												Juin 2019	
FLUX Ligne 4													
Unité Kg	CO ₂ _FLUX_L4	COT_FLUX_L4	HCL_FLUX_L4	NOX_FLUX_L4	POUSS_FLUX_L4	SO ₂ _FLUX_L4	NH ₃ _FLUX_L4	MarcheFourL4_30					
VLE Jour	Kg	Kg	Kg	Kg	Kg	Kg	Kg	hh	mm	ss			
	23.25	5.85	5.85	5.85	58.5	4.69	17.55	5.85					
01/06/2019	1.87	0.00	0.00	3.24	26.52	0.45	1.13	0.24			20:56:10		
02/06/2019	1.78	0.00	0.00	2.55	17.65	0.34	1.02	0.31			16:47:00		
03/06/2019	2.63	0.07	0.07	3.19	30.97	0.44	1.33	0.25			17:59:50		
04/06/2019	0.29	0.01	0.01	2.16	27.53	0.34	0.81	0.15			12:23:50		
05/06/2019	2.93	0.07	0.07	1.50	15.81	0.23	0.97	0.12			11:19:20		
06/06/2019	0.65	0.00	0.00	4.24	44.25	0.56	3.10	0.22			22:54:50		
07/06/2019	0.91	0.01	0.01	4.55	41.89	0.70	2.55	0.19			22:25:50		
08/06/2019	2.34	0.02	0.02	3.46	38.70	0.51	2.32	0.26			22:15:40		
09/06/2019	1.33	0.02	0.02	3.96	46.25	0.60	4.74	0.26			23:42:00		
10/06/2019	0.95	0.00	0.00	4.37	41.86	0.59	2.24	0.30			23:56:40		
11/06/2019	0.72	0.00	0.00	3.52	48.11	0.58	3.47	0.21			23:40:50		
12/06/2019	1.30	0.01	0.01	3.45	33.77	0.51	3.30	0.20			22:58:30		
13/06/2019	0.41	0.00	0.00	4.28	45.93	0.50	2.85	0.24			23:15:30		
14/06/2019	1.16	0.01	0.01	3.89	35.32	0.56	1.85	0.37			23:02:40		
15/06/2019	1.78	0.03	0.03	3.67	49.34	0.58	3.33	0.14			23:31:50		
16/06/2019	0.91	0.00	0.00	3.96	42.34	0.56	3.36	0.14			23:10:30		
17/06/2019	1.22	0.00	0.00	41.61	41.61	0.51	2.61	0.18			23:20:20		
18/06/2019	2.14	0.03	0.03	2.84	28.09	0.41	1.05	0.22			19:21:50		
19/06/2019	1.05	0.00	0.00	3.62	40.79	0.47	1.30	0.48			23:10:20		
20/06/2019	2.37	0.02	0.02	4.12	40.75	0.57	1.36	0.42			23:51:10		
21/06/2019	2.20	0.00	0.00	3.67	33.21	0.51	1.21	0.39			23:23:40		
22/06/2019	1.95	0.00	0.00	3.54	25.31	0.51	1.18	0.42			24:00:00		
23/06/2019	1.36	0.00	0.00	2.07	15.27	0.32	0.73	0.23			15:24:20		
24/06/2019	6.27	0.03	0.03	1.46	20.58	0.33	0.66	0.19			15:55:00		
25/06/2019	2.19	0.02	0.02	2.43	21.33	0.50	1.19	0.37			22:44:10		
26/06/2019	2.30	0.02	0.02	3.70	30.22	0.62	1.70	0.56			23:54:00		
27/06/2019	2.34	0.00	0.00	2.61	24.11	0.43	1.04	0.33			21:14:00		
28/06/2019	2.00	0.01	0.01	3.48	25.59	0.54	1.40	0.41			22:45:10		
29/06/2019	1.29	0.01	0.01	3.70	26.41	0.61	1.45	0.50			22:42:20		
30/06/2019	0.64	0.00	0.00	3.26	19.06	0.43	1.66	0.33			17:47:50		
Min	0.29	0.00	0.00	1.46	15.27	0.23	0.66	0.12					
Max	6.27	0.07	0.07	4.55	49.34	0.70	4.74	0.56					
Cumul	51.28	0.39	0.39	99.92	978.57	14.81	56.91	8.63			261 09:55:10		
VLE Flux Jour	0	0	0	0	0	0	0	0					



Rapport DREAL Flux Mensuel Ligne 4

Rapport Flux Mensuel											Juillet 2019	
FLUX Ligne 4												
Unité Kg	CO2_FLUX_L4	COT_FLUX_L4	HCL_FLUX_L4	NOX_FLUX_L4	POUSS_FLUX_L4	SO2_FLUX_L4	NH3_FLUX_L4	MarcheFourL4_30				
VLE Jour	23.25	5.85	Kg	Kg	Kg	Kg	Kg	hh:mm:ss	17.55	5.85		
01/07/2019	2.92	0.01	2.40	2.40	19.73	0.39	0.97	18:05:40	0.97	0.38		
02/07/2019	3.67	0.00	3.10	3.10	24.12	0.50	1.34	23:33:20	1.34	0.33		
03/07/2019	2.23	0.01	3.25	3.25	26.84	0.49	1.36	23:22:20	1.36	0.25		
04/07/2019	1.32	0.01	3.67	3.67	26.15	0.55	1.45	23:49:20	1.45	0.37		
05/07/2019	2.02	0.02	3.09	3.09	23.69	0.47	1.17	20:51:40	1.17	0.44		
06/07/2019	2.14	0.15	2.97	2.97	26.23	0.53	1.07	22:02:20	1.07	0.49		
07/07/2019	3.23	0.04	2.43	2.43	18.54	0.54	1.18	23:30:50	1.18	0.59		
08/07/2019	4.58	0.00	2.82	2.82	18.73	0.48	1.03	23:17:20	1.03	0.38		
09/07/2019	3.10	0.01	3.22	3.22	18.68	0.54	1.12	22:35:00	1.12	0.52		
10/07/2019	3.12	0.02	2.94	2.94	18.27	0.44	0.93	18:57:00	0.93	0.40		
11/07/2019	1.86	0.01	4.09	4.09	23.63	0.59	1.22	24:00:00	1.22	0.64		
12/07/2019	1.67	0.17	4.11	4.11	31.81	0.52	1.18	23:23:10	1.18	0.45		
13/07/2019	0.97	0.00	3.59	3.59	27.72	0.53	1.36	23:48:50	1.36	0.37		
14/07/2019	0.55	0.00	1.83	1.83	20.03	0.24	0.88	10:25:10	0.88	0.15		
15/07/2019	1.15	0.00	0.85	0.85	6.48	0.14	0.33	06:07:20	0.33	0.08		
16/07/2019	1.41	0.00	3.55	3.55	29.98	0.54	1.40	22:07:00	1.40	0.44		
17/07/2019	1.67	0.00	4.28	4.28	26.59	0.55	1.43	23:11:40	1.43	0.46		
18/07/2019	1.43	0.00	3.38	3.38	27.25	0.47	1.73	20:45:00	1.73	0.37		
19/07/2019	1.94	0.00	3.77	3.77	40.09	0.56	1.47	23:55:10	1.47	0.48		
20/07/2019	1.53	0.00	4.05	4.05	28.00	0.57	1.53	23:38:30	1.53	0.56		
21/07/2019	0.78	0.00	1.55	1.55	8.08	0.19	0.69	09:28:30	0.69	0.11		
22/07/2019	4.24	0.01	2.86	2.86	17.76	0.45	0.83	17:02:00	0.83	0.35		
23/07/2019	1.42	0.01	3.82	3.82	25.25	0.69	1.03	23:45:50	1.03	0.48		
24/07/2019	1.61	0.06	2.25	2.25	18.43	0.56	0.85	16:45:50	0.85	0.56		
25/07/2019	1.47	0.00	1.62	1.62	15.34	0.35	0.86	13:04:10	0.86	0.31		
26/07/2019	2.24	0.00	2.42	2.42	25.25	0.48	1.20	21:09:10	1.20	0.52		
27/07/2019	5.42	0.00	3.64	3.64	28.43	0.53	1.26	23:01:30	1.26	0.56		
28/07/2019	2.06	0.00	2.63	2.63	18.13	0.35	1.01	16:18:50	1.01	0.43		
29/07/2019	1.51	0.00	0.65	0.65	7.31	0.11	0.29	06:48:30	0.29	0.08		
30/07/2019	3.88	0.00	3.70	3.70	22.50	0.44	1.48	23:39:00	1.48	0.46		
31/07/2019	2.22	0.00	2.85	2.85	32.31	0.45	1.27	22:21:10	1.27	0.42		
Min	0.55	0.00	0.65	0.65	6.48	0.11	0.29	0.08	0.29	0.08		
Max	5.42	0.17	4.28	4.28	40.09	0.69	1.73	0.64	1.73	0.64		
Annul	69.36	0.53	91.38	91.38	701.35	14.24	34.92	12.43	34.92	12.43		
VLE Flux Jour	0	0	0	0	0	0	0	0	0	0		
									25j	14:51:10		



Rapport DREAL Flux Mensuel Ligne 4

Rapport Flux Mensuel												Aout 2019	
FLUX Ligne 4													
CO_30_FLUX_L4	COT_FLUX_L4	HCL_FLUX_L4	NOX_FLUX_L4	POUSS_FLUX_L4	SO2_FLUX_L4	NH3_FLUX_L4	MarcheFourL4_30						
Unité Kg	Kg	Kg	Kg	Kg	Kg	Kg	hh:mm:ss						
VLE Jour	23.25	5.85	5.85	58.5	4.69	17.55	5.85						
01/08/2019	1.35	0.00	3.47	34.73	0.46	1.34	0.39					22:55:40	
02/08/2019	1.03	0.00	3.48	36.88	0.47	1.38	0.51					22:51:30	
03/08/2019	0.89	0.00	3.31	35.70	0.50	1.51	0.33					23:54:50	
04/08/2019	Arrêt	Arrêt	Arrêt	Arrêt	Arrêt	Arrêt	Arrêt					00:19:40	
05/08/2019	5.04	0.02	2.63	35.08	0.46	1.61	0.18					20:17:20	
06/08/2019	2.30	0.01	3.00	29.24	0.51	1.39	0.28					23:34:40	
07/08/2019	2.43	0.01	3.75	33.33	0.53	1.41	0.18					23:34:00	
08/08/2019	1.02	0.00	3.49	29.37	0.50	1.38	0.28					23:29:50	
09/08/2019	1.81	0.00	2.73	28.60	0.46	1.37	0.27					22:00:50	
10/08/2019	1.33	0.01	3.87	35.28	0.51	1.35	0.34					23:02:30	
11/08/2019	0.23	0.00	1.69	9.59	0.20	0.77	0.09					10:07:10	
12/08/2019	3.62	0.01	2.44	17.37	0.29	0.63	0.16					15:45:00	
13/08/2019	0.97	0.00	3.78	30.63	0.45	1.04	0.30					23:29:40	
14/08/2019	2.06	0.00	3.44	23.25	0.42	1.07	0.26					21:50:10	
15/08/2019	0.75	0.00	2.42	22.48	0.29	0.84	0.23					17:03:30	
16/08/2019	2.25	0.00	2.42	25.33	0.47	1.18	0.27					20:15:20	
17/08/2019	0.11	0.00	0.52	3.54	0.06	0.30	0.03					03:32:20	
18/08/2019	Arrêt	Arrêt	Arrêt	Arrêt	Arrêt	Arrêt	Arrêt					00:00:00	
19/08/2019	4.52	0.01	3.09	18.26	0.36	0.98	0.18					15:38:00	
20/08/2019	Arrêt	Arrêt	Arrêt	Arrêt	Arrêt	Arrêt	Arrêt					00:00:00	
21/08/2019	Arrêt	Arrêt	Arrêt	Arrêt	Arrêt	Arrêt	Arrêt					00:00:00	
22/08/2019	Arrêt	Arrêt	Arrêt	Arrêt	Arrêt	Arrêt	Arrêt					00:00:00	
23/08/2019	Arrêt	Arrêt	Arrêt	Arrêt	Arrêt	Arrêt	Arrêt					00:00:00	
24/08/2019	Arrêt	Arrêt	Arrêt	Arrêt	Arrêt	Arrêt	Arrêt					00:00:00	
25/08/2019	Arrêt	Arrêt	Arrêt	Arrêt	Arrêt	Arrêt	Arrêt					00:00:00	
26/08/2019	Arrêt	Arrêt	Arrêt	Arrêt	Arrêt	Arrêt	Arrêt					00:00:00	
27/08/2019	Arrêt	Arrêt	Arrêt	Arrêt	Arrêt	Arrêt	Arrêt					00:00:00	
28/08/2019	Arrêt	Arrêt	Arrêt	Arrêt	Arrêt	Arrêt	Arrêt					00:00:00	
29/08/2019	Arrêt	Arrêt	Arrêt	Arrêt	Arrêt	Arrêt	Arrêt					00:00:00	
30/08/2019	Arrêt	Arrêt	Arrêt	Arrêt	Arrêt	Arrêt	Arrêt					00:00:00	
31/08/2019	Arrêt	Arrêt	Arrêt	Arrêt	Arrêt	Arrêt	Arrêt					00:00:00	
Min	0.11	0.00	0.52	3.54	0.06	0.30	0.03					0.03	
Max	5.04	0.02	3.87	36.88	0.53	1.61	0.51					0.51	
Cumul	31.71	0.07	49.53	448.66	6.94	19.55	4.28					4.28	
VLE Flux Jour	0	0	0	0	0	0	0					0	
												13j 21:42:00	



Rapport DREAL Flux Mensuel Ligne 4

Rapport Flux Mensuel											Septembre 2019	
FLUX Ligne 4												
Unité Kg	CO ₂ _FLUX_L4	CO ₁ _FLUX_L4	HCL_FLUX_L4	NOX_FLUX_L4	POUSS_FLUX_L4	SO ₂ _FLUX_L4	NH ₃ _FLUX_L4	MarcheFourL4_30				
VLE Jour	23.25	5.85	5.85	5.85	58.5	4.69	17.55	hh:mm:ss	5.85			
01/09/2019	Arrêt	Arrêt	Arrêt	Arrêt	Arrêt	Arrêt	Arrêt	Arrêt	Arrêt	00:00:00		
02/09/2019	Arrêt	Arrêt	Arrêt	Arrêt	Arrêt	Arrêt	Arrêt	Arrêt	Arrêt	00:00:00		
03/09/2019	Arrêt	Arrêt	Arrêt	Arrêt	Arrêt	Arrêt	Arrêt	Arrêt	Arrêt	00:00:00		
04/09/2019	Arrêt	Arrêt	Arrêt	Arrêt	Arrêt	Arrêt	Arrêt	Arrêt	Arrêt	00:00:00		
05/09/2019	Arrêt	Arrêt	Arrêt	Arrêt	Arrêt	Arrêt	Arrêt	Arrêt	Arrêt	00:00:00		
06/09/2019	Arrêt	Arrêt	Arrêt	Arrêt	Arrêt	Arrêt	Arrêt	Arrêt	Arrêt	00:00:00		
07/09/2019	Arrêt	Arrêt	Arrêt	Arrêt	Arrêt	Arrêt	Arrêt	Arrêt	Arrêt	00:00:00		
08/09/2019	Arrêt	Arrêt	Arrêt	Arrêt	Arrêt	Arrêt	Arrêt	Arrêt	Arrêt	00:00:00		
09/09/2019	0.65	0.04	0.04	1.02	10.00	0.17	4.18	0.34	0.34	08:14:50		
10/09/2019	1.25	0.03	0.03	4.37	34.70	0.45	3.46	1.35	1.35	23:25:30		
11/09/2019	2.09	0.02	0.02	2.49	20.24	0.34	0.82	1.05	1.05	18:30:30		
12/09/2019	1.32	0.03	0.03	2.79	25.08	0.38	1.13	0.59	0.59	19:24:20		
13/09/2019	Arrêt	Arrêt	Arrêt	Arrêt	Arrêt	Arrêt	Arrêt	Arrêt	Arrêt	00:00:00		
14/09/2019	2.25	0.00	0.00	2.81	26.83	0.42	1.20	0.40	0.40	23:29:00		
15/09/2019	1.60	0.02	0.02	2.79	20.18	0.33	1.01	0.29	0.29	18:07:40		
16/09/2019	5.42	0.02	0.02	2.25	19.28	0.32	0.75	0.73	0.73	16:23:40		
17/09/2019	1.45	0.00	0.00	4.49	30.04	0.57	1.56	1.05	1.05	23:10:50		
18/09/2019	1.98	0.00	0.00	4.04	30.07	0.60	1.62	0.75	0.75	23:09:30		
19/09/2019	3.42	0.03	0.03	2.28	20.91	0.37	0.88	0.54	0.54	16:33:40		
20/09/2019	3.28	0.01	0.01	3.65	28.58	0.47	1.20	0.90	0.90	23:34:30		
21/09/2019	1.63	0.00	0.00	4.00	29.68	0.48	1.44	0.88	0.88	23:50:40		
22/09/2019	1.69	0.06	0.06	2.71	23.81	0.36	1.34	0.61	0.61	19:08:00		
23/09/2019	1.99	0.02	0.02	3.11	20.20	0.35	0.91	0.66	0.66	17:37:10		
24/09/2019	3.69	0.03	0.03	3.56	28.28	0.45	1.41	0.74	0.74	22:25:40		
25/09/2019	1.88	0.03	0.03	4.37	26.77	0.46	1.72	0.84	0.84	22:38:40		
26/09/2019	2.05	0.07	0.07	4.01	26.90	0.47	1.86	1.06	1.06	23:11:40		
27/09/2019	1.62	0.01	0.01	4.34	34.31	0.51	2.13	1.06	1.06	23:47:30		
28/09/2019	1.54	0.00	0.00	4.25	27.89	0.46	2.00	0.88	0.88	23:10:30		
29/09/2019	1.49	0.02	0.02	2.20	15.42	0.26	1.13	0.39	0.39	13:13:20		
30/09/2019	3.72	0.01	0.01	3.12	21.47	0.33	0.92	0.32	0.32	16:14:00		
Min	0.65	0.00	0.00	1.02	10.00	0.17	0.75	0.29	0.29			
Max	5.42	0.07	0.07	4.49	34.70	0.60	4.18	1.35	1.35			
Cumul	46.01	0.45	0.45	68.65	520.64	8.55	32.67	15.43	15.43	17j 11:21:10		
VLE Flux Jour	0	0	0	0	0	0	0	0	0			



Rapport DREAL Flux Mensuel Ligne 4

Rapport Flux Mensuel											Octobre 2019	
FLUX Ligne 4												
CO_30_FLUX_L4	COT_FLUX_L4	HCL_FLUX_L4	NOX_FLUX_L4	POUSS_FLUX_L4	SO2_FLUX_L4	NHB_FLUX_L4	MarcheFourL4_30					
Unité Kg	Kg	Kg	Kg	Kg	Kg	Kg	hh:mm:ss					
VLE Jour	23.25	5.85	5.85	58.5	4.69	17.55	5.85					
01/10/2019	1.34	0.03	4.21	29.90	0.45	1.75	23:19:40					
02/10/2019	1.35	0.00	4.77	32.28	0.50	1.99	23:30:40					
03/10/2019	0.96	0.00	2.69	22.09	0.38	1.26	18:02:50					
04/10/2019	1.43	0.00	4.67	32.63	0.51	1.50	23:49:00					
05/10/2019	2.38	0.00	4.24	29.91	0.45	1.49	23:51:20					
06/10/2019	1.71	0.00	2.78	18.66	0.66	1.26	19:16:40					
07/10/2019	2.62	0.00	3.03	24.96	0.40	1.53	19:57:10					
08/10/2019	2.46	0.01	3.77	27.07	0.45	1.54	23:04:40					
09/10/2019	3.87	0.02	2.23	20.21	0.43	1.09	20:13:00					
10/10/2019	1.20	0.00	2.67	18.73	0.29	1.08	15:06:10					
11/10/2019	Arrêt	Arrêt	Arrêt	Arrêt	Arrêt	Arrêt	00:00:00					
12/10/2019	Arrêt	Arrêt	Arrêt	Arrêt	Arrêt	Arrêt	00:00:00					
13/10/2019	Arrêt	Arrêt	Arrêt	Arrêt	Arrêt	Arrêt	00:00:00					
14/10/2019	Arrêt	Arrêt	Arrêt	Arrêt	Arrêt	Arrêt	00:00:00					
15/10/2019	Arrêt	Arrêt	Arrêt	Arrêt	Arrêt	Arrêt	00:00:00					
16/10/2019	1.56	0.00	0.16	2.55	0.03	0.08	01:47:30					
17/10/2019	4.83	0.05	4.33	29.98	0.51	1.62	23:37:40					
18/10/2019	1.54	0.00	4.27	36.09	0.50	1.73	22:57:50					
19/10/2019	1.91	0.00	4.63	38.51	0.54	1.94	24:00:00					
20/10/2019	2.85	0.01	0.20	4.23	0.06	0.16	03:03:20					
21/10/2019	4.50	0.00	4.92	34.71	0.40	1.60	22:58:50					
22/10/2019	1.72	0.00	3.79	32.14	0.14	1.06	22:26:50					
23/10/2019	1.93	0.00	4.83	30.27	0.12	0.93	21:48:40					
24/10/2019	1.98	0.01	4.61	31.06	0.13	1.10	23:25:50					
25/10/2019	1.27	0.00	5.00	31.59	0.14	0.88	23:18:10					
26/10/2019	1.37	0.04	3.50	31.14	0.13	0.68	22:38:50					
27/10/2019	0.87	0.01	2.51	20.29	0.09	1.02	18:01:30					
28/10/2019	2.86	0.01	2.84	24.92	0.10	0.92	17:24:40					
29/10/2019	2.41	0.01	3.33	31.00	0.12	1.03	20:33:30					
30/10/2019	3.13	0.03	4.46	31.75	0.13	1.06	22:21:30					
31/10/2019	3.31	0.03	5.11	36.57	0.15	1.14	23:41:10					
Min	0.87	0.00	0.16	2.55	0.03	0.08	0.04					
Max	4.83	0.05	5.11	38.51	0.66	1.99	1.10					
Cumul	57.36	0.26	93.55	703.24	7.81	31.07	16.55					
VLE Flux Jour	0	0	0	0	0	0	0	21j 20:17:00				

Rapport DREAL Flux Mensuel Ligne 4

Rapport Flux Mensuel											Novembre 2019	
FLUX Ligne 4												
Unité Kg	CO_30_FLUX_L4	COT_FLUX_L4	HCL_FLUX_L4	NOX_FLUX_L4	POUSS_FLUX_L4	SO2_FLUX_L4	NH3_FLUX_L4	MarcheFourL4_30				
VLE Jour	23.25	5.85	5.85	5.85	58.5	4.69	17.55	hh:mm:ss	5.85			
01/11/2019	2.36	0.02	0.02	5.46	32.00	0.30	0.76	0.92	22:49:20			
02/11/2019	3.49	0.03	0.03	2.33	18.74	0.08	0.65	0.29	14:04:40			
03/11/2019	1.46	0.00	0.00	0.97	6.41	0.03	0.19	0.11	05:38:20			
04/11/2019	9.20	0.07	0.07	2.74	16.91	0.08	0.46	0.31	15:38:20			
05/11/2019	2.84	0.01	0.01	5.20	29.05	0.12	0.85	0.46	23:22:20			
06/11/2019	2.26	0.00	0.00	3.55	28.66	0.12	0.52	0.41	23:17:50			
07/11/2019	2.02	0.00	0.00	4.89	31.36	0.14	0.64	0.67	22:50:40			
08/11/2019	1.97	0.00	0.00	3.61	28.04	0.13	0.55	0.48	22:34:20			
09/11/2019	3.77	0.00	0.00	4.35	29.77	0.14	0.64	0.62	23:05:30			
10/11/2019	2.94	0.00	0.00	2.90	24.18	0.11	4.40	0.47	19:20:30			
11/11/2019	Arrêt	Arrêt	Arrêt	Arrêt	Arrêt	Arrêt	Arrêt	Arrêt	00:00:00			
12/11/2019	Arrêt	Arrêt	Arrêt	Arrêt	Arrêt	Arrêt	Arrêt	Arrêt	00:00:00			
13/11/2019	Arrêt	Arrêt	Arrêt	Arrêt	Arrêt	Arrêt	Arrêt	Arrêt	00:00:00			
14/11/2019	11.54	0.05	0.05	1.25	25.40	0.12	0.32	0.46	18:36:50			
15/11/2019	1.64	0.00	0.00	2.83	32.94	0.20	0.54	0.45	24:00:00			
16/11/2019	1.51	0.00	0.00	4.28	31.44	0.15	0.48	0.44	23:42:30			
17/11/2019	0.38	0.00	0.00	1.33	9.64	0.05	0.16	0.12	08:04:40			
18/11/2019	4.87	0.01	0.01	2.70	25.84	0.13	0.24	0.18	18:50:50			
19/11/2019	1.36	0.00	0.00	4.64	31.67	0.20	0.40	0.29	23:20:30			
20/11/2019	3.22	0.00	0.00	3.81	25.44	0.13	0.42	0.22	21:06:30			
21/11/2019	1.75	0.00	0.00	5.09	32.49	0.15	0.46	0.42	23:34:10			
22/11/2019	1.20	0.00	0.00	4.24	30.34	0.14	0.54	0.43	23:23:50			
23/11/2019	1.11	0.00	0.00	5.09	35.04	0.16	0.58	0.37	23:30:10			
24/11/2019	0.82	0.00	0.00	3.78	30.87	0.14	0.46	0.18	23:37:20			
25/11/2019	1.36	0.00	0.00	3.52	23.81	0.10	0.50	0.22	17:58:00			
26/11/2019	1.06	0.00	0.00	4.97	36.93	0.15	0.43	0.38	23:51:30			
27/11/2019	1.01	0.00	0.00	3.57	29.43	0.13	0.32	0.23	22:54:50			
28/11/2019	1.11	0.00	0.00	4.37	33.58	0.14	0.47	0.33	23:43:50			
29/11/2019	1.31	0.00	0.00	4.63	34.94	0.15	0.34	0.27	24:00:00			
30/11/2019	0.95	0.00	0.00	5.42	37.03	0.17	0.37	0.31	24:00:00			
Min	0.38	0.00	0.00	0.97	6.41	0.03	0.16	0.11				
Max	11.54	0.07	0.07	5.46	37.03	0.30	4.40	0.92				
Cumul	68.51	0.19	0.19	101.52	751.95	3.66	16.69	10.04	23j 08:57:20			
VLE Flux Jour	0	0	0	0	0	0	0	0				

Rapport DREAL Flux Mensuel Ligne 4

Rapport Flux Mensuel											Decembre 2019	
FLUX Ligne 4												
Unité	CO_30_FLUX_L4	COT_FLUX_L4	HCL_FLUX_L4	NOX_FLUX_L4	POUSS_FLUX_L4	SO2_FLUX_L4	NH3_FLUX_L4	MarcheFourL4_30				
VLE Jour	Kg	Kg	Kg	Kg	Kg	Kg	Kg	hh:mm:ss				
	23.25	5.85	5.85	58.5	4.69	17.55	5.85					
01/12/2019	1.59	0.00	3.40	36.53	0.15	0.35	0.25			22:21:40		
02/12/2019	1.18	0.01	4.99	39.32	0.17	0.41	0.41			23:37:10		
03/12/2019	1.11	0.00	5.20	35.64	0.17	0.41	0.35			23:44:50		
04/12/2019	1.18	0.00	3.73	28.50	0.14	0.53	0.38			21:43:30		
05/12/2019	2.85	0.00	3.73	30.89	0.16	0.34	0.44			22:42:30		
06/12/2019	0.85	0.00	4.84	39.44	0.17	0.32	0.69			23:32:30		
07/12/2019	0.96	0.00	4.97	38.64	0.15	0.36	0.59			23:52:20		
08/12/2019	2.96	0.01	2.28	23.57	0.10	0.24	0.42			18:26:20		
09/12/2019	2.98	0.00	3.50	25.30	0.12	0.25	0.44			21:26:40		
10/12/2019	1.29	0.00	4.51	31.44	0.15	0.44	0.38			23:42:30		
11/12/2019	1.55	0.00	4.69	32.20	0.16	0.39	0.50			23:20:30		
12/12/2019	2.23	0.00	4.60	41.20	0.17	0.40	0.76			22:46:30		
13/12/2019	2.85	0.01	4.17	42.53	0.14	0.37	0.84			21:19:00		
14/12/2019	0.83	0.00	4.88	44.41	0.15	0.40	0.68			23:48:50		
15/12/2019	0.53	0.00	2.03	28.35	0.08	0.17	0.18			14:04:50		
16/12/2019	3.94	0.00	1.66	29.12	0.09	0.26	0.15			16:23:00		
17/12/2019	1.55	0.01	4.23	38.64	0.13	0.44	0.29			22:56:00		
18/12/2019	1.27	0.00	4.38	36.85	0.14	0.40	0.43			23:37:20		
19/12/2019	1.60	0.00	4.23	29.44	0.12	0.38	0.36			23:17:00		
20/12/2019	1.86	0.00	4.08	35.85	0.13	0.31	0.47			23:58:00		
21/12/2019	1.13	0.00	4.61	38.39	0.16	0.45	0.66			24:00:00		
22/12/2019	1.20	0.00	2.65	23.76	0.09	0.30	0.28			15:17:10		
23/12/2019	2.05	0.01	2.35	23.04	0.09	0.17	0.13			16:57:30		
24/12/2019	1.16	0.00	3.91	32.52	0.12	0.35	0.31			23:53:10		
25/12/2019	1.81	0.00	3.59	31.45	0.12	0.40	0.42			23:17:40		
26/12/2019	2.93	0.01	1.09	14.62	0.07	0.15	0.16			12:41:00		
27/12/2019	1.74	0.00	1.25	19.95	0.08	0.21	0.48			17:52:10		
28/12/2019	1.80	0.01	2.46	25.52	0.10	0.23	0.39			19:56:50		
29/12/2019	Arrêt	Arrêt	Arrêt	Arrêt	Arrêt	Arrêt	Arrêt			00:00:00		
30/12/2019	4.62	0.18	3.26	24.20	0.12	0.24	0.27			18:54:50		
31/12/2019	1.75	0.09	3.73	34.10	0.14	0.46	0.41			23:05:10		
Min	0.53	0.00	1.09	14.62	0.07	0.15	0.13			0		
Max	4.62	0.18	5.20	44.41	0.17	0.53	0.84			26j 12:36:30		
Cumul	55.35	0.34	109.00	955.41	3.88	10.15	12.52			0		
VLE Flux Jour	0	0	0	0	0	0	0			0		

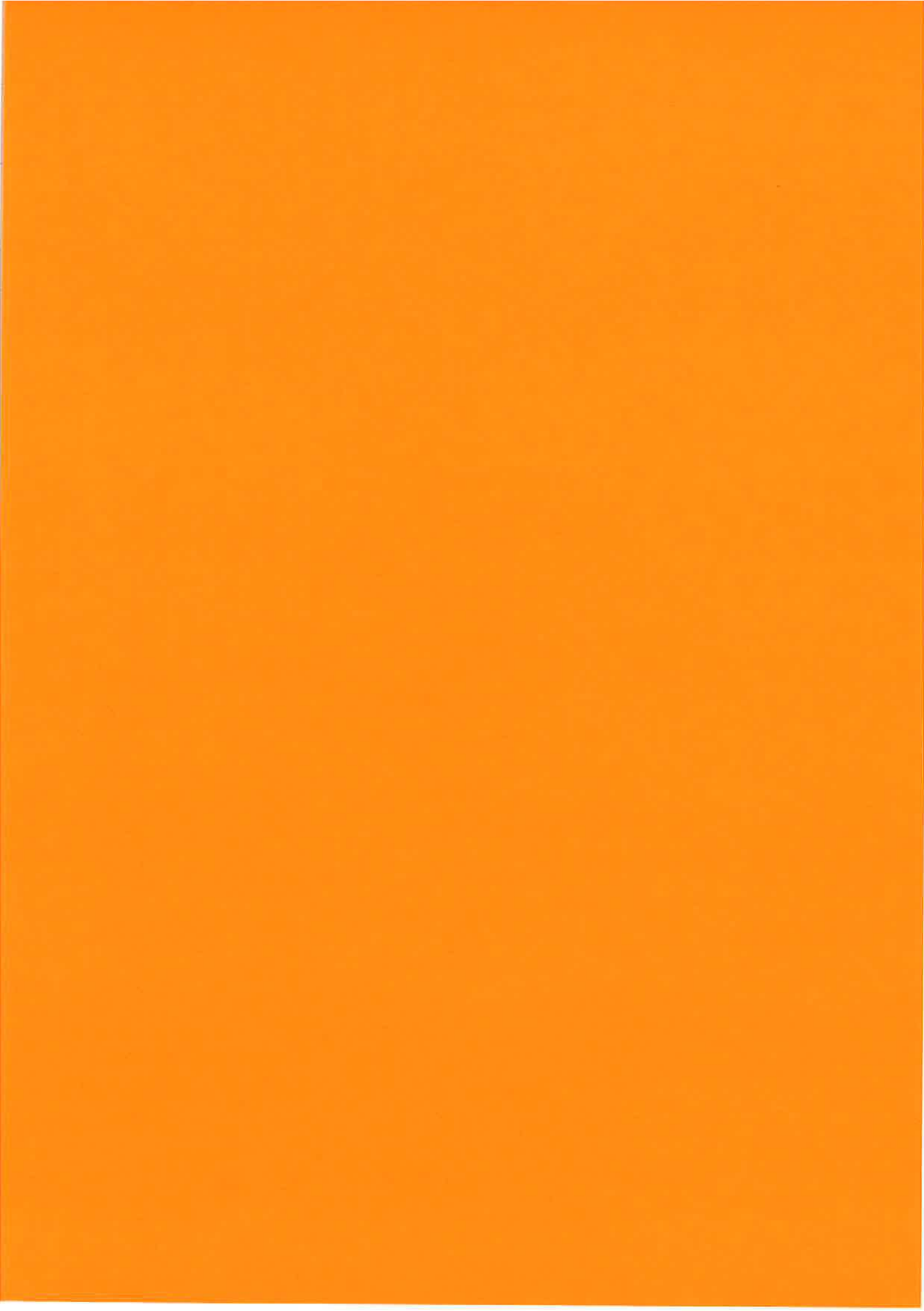



Rapport DREAL Mensuel Ligne 4

Rapport Mensuel		Mesure IC95 Ligné4													Février 2019	
Unité	CO	COT	HCL	NEH3	NOX	POUSSIÈRE	SO2	Vitesse0_V4_2C	O2	TZS_30_L4	MarcheFouLA_30	Tonnage DASRI				
VLE Jour	mg/Nm3	mg/Nm3	mg/Nm3	mg/Nm3	mg/Nm3	mg/Nm3	mg/Nm3	m/s	%	degreC	hh.mm.ss	Tonne				
VLE Max	50	100	10	10	10	100	10	50								
Seuil Min.	100	100	20	60	20	60	150	200	12		850					
VLE 1/2h	100	100	20	60	20	60	30	200	12		850					
01/02/2019	10.04		0.00	7.95	1.54	64.17	1.365	2.40	22.51	11.13	974.6	23.53.00	0.0			
02/02/2019	8.61		0.00	8.87	1.28	66.53	1.202	2.39	22.14	11.02	978.7	23.52.00	0.0			
03/02/2019	24.82		0.00	8.07	1.80	67.32	1.220	2.55	22.63	11.05	986.8	22.17.30	0.0			
04/02/2019	16.27	0.02	0.02	7.69	1.74	63.13	1.258	2.45	22.05	11.17	971.6	23.57.40	0.0			
05/02/2019	7.70		0.00	8.74	1.30	65.36	1.205	2.38	22.58	11.14	986.6	23.55.50	0.0			
06/02/2019	6.54		0.00	8.20	1.28	67.85	1.163	2.35	21.61	10.94	987.7	23.49.20	0.0			
07/02/2019	3.11		0.00	7.40	1.26	64.75	1.164	2.39	22.62	11.13	986.6	23.47.10	0.0			
08/02/2019	1.58		0.00	7.74	1.32	63.19	1.205	2.32	21.78	10.93	969.5	23.26.20	438.0			
09/02/2019	5.64		0.00	8.45	1.11	65.06	1.158	2.45	21.97	11.18	981.4	23.19.20	0.0			
10/02/2019	4.76		0.00	7.53	1.11	65.77	1.158	2.44	21.64	11.18	987.2	24.00.00	0.0			
11/02/2019	2.61		0.00	7.59	0.89	63.09	1.187	2.39	21.48	11.17	963.3	24.00.00	0.0			
12/02/2019	2.61		0.00	6.68	0.94	62.63	1.217	2.41	22.37	11.17	974.1	23.57.30	0.0			
13/02/2019	8.28		0.00	6.73	1.06	65.82	1.212	2.45	22.85	11.16	985.6	24.00.00	0.0			
14/02/2019	6.64		0.00	7.45	1.38	66.55	1.245	2.61	23.66	11.31	983.0	01.33.00	0.0			
15/02/2019	19.40	0.03	0.03	4.60	0.50	66.89	1.036	3.12	17.31	10.33	971.8	06.12.50	0.0			
16/02/2019	8.57	0.01	0.01	7.03	0.84	77.06	1.096	2.37	16.88	10.54	1003.7	22.01.00	0.0			
17/02/2019	2.55		0.00	6.62	0.80	78.17	1.096	2.83	16.07	10.70	999.2	23.39.40	191.8			
18/02/2019	3.04		0.00	6.33	1.11	63.93	1.225	2.95	19.21	11.71	961.2	23.58.40	0.0			
19/02/2019	4.33		0.00	7.56	1.07	63.15	1.190	2.58	18.26	11.51	964.8	23.28.50	0.0			
20/02/2019	5.87		0.00	7.09	0.94	61.84	1.167	2.50	17.38	11.29	971.3	23.36.10	0.0			
21/02/2019	4.16		0.00	7.00	1.04	64.93	1.095	2.42	16.44	10.80	982.6	23.54.00	0.0			
22/02/2019	2.01		0.00	5.87	1.20	59.31	1.112	2.45	18.21	11.04	982.1	24.00.00	0.0			
23/02/2019	2.19		0.00	6.80	1.17	73.10	1.078	2.47	17.88	10.95	1006.0	24.00.00	0.0			
24/02/2019	7.85		0.00	6.63	0.94	78.40	1.073	2.44	18.03	10.91	1008.8	23.40.20	0.0			
25/02/2019	12.26	0.09	0.09	6.54	0.95	79.81	1.087	4.37	17.61	10.62	970.1	05.07.00	84.5			
26/02/2019	10.86		0.00	7.18	0.92	72.40	1.149	4.63	18.63	11.42	971.0	23.36.20	0.0			
27/02/2019	8.33		0.00	7.59	1.01	76.17	1.146	4.91	19.60	11.39	976.7	23.06.30	0.0			
28/02/2019	24.82	0.09	0.09	8.87	1.80	79.81	1.365	4.91	23.66	11.71	1008.8	23.59.40	0.0			
Max.	1.58	0.80	0.80	4.60	0.50	59.31	1.036	2.32	16.07	10.33	961.2	0.0	0.0			
Min.	0	0	0	0	0	0	0	0	0	0	0	0	0	0		
Dep. VLE jour	0	0	0	0	0	0	0	0	0	0	0	0	0	0		
Nb Jour Inva.	0	0	0	0	0	0	0	0	0	0	0	0	0	0		
Dep. VLE Max	00-100	00-100	00-100	00-100	00-100	00-100	00-100	00-100	00-100	00-100	00-100	00-100	00-100	00-100		
Dep. Seuil Min.																
Dep. VLE 1/2h	2	0	0	0	0	0	0	0	00-100	00-100	00-100	00-100	00-100	00-100		
Moy. Mensuelle	7.11	0.01	0.01	7.32	1.14	67.51	1.169	2.73	20.08	11.09	981.1	25J 04-09-40	714.3			
% deannées HG	0.00	0.00	0.00	0.00	0.00	0.00	0.000	0.00	0.00	0.00	0.0	0	0.0			
% deannées HG Annuel	0.00	0.00	0.00	0.00	0.00	0.00	0.000	0.00	0.00	0.00	0.0	0	0.0			

Contrôle réglementaire L4 - 2019 [CO]													Global	
Dépassement >4H													Global	
Nb jour invalides													Global	
Indis. Cons > 10h													Global	
Indisponibilité													Global	
Dépassement >4H													0	0
Nb jour invalides													06:00	00:00
Indis. Cons > 10h													0	0
Indisponibilité													02:00	00:00
* Le 04/02/2019, dépassement d'une moyenne 30' en CO à 119.89 mg/Nm3 (pour une limite à 100) suite à un manque de chargement en déchets du four.														
* Le 17/02/2019, dépassement d'une moyenne 30' en CO à 117.02 mg/Nm3 (pour une limite à 100) suite à un chargement discontinu du four (problème sur la manutention robotisée).														



Rapport DREAL Mensuel Ligne 4

Mensure IC95 Ligné4		Mars 2019												
Unité	CO	COT	HCL	NH3	NOX	POUSSIERE	SO2	Vitesse30_T4_2C	O2	T2S_30_J4	MarcheFourL4_30	Tonnage DASRI		
VLE Jour	mg/Nm3	mg/Nm3	mg/Nm3	mg/Nm3	mg/Nm3	mg/Nm3	mg/Nm3	m/s	%	degreC	h/m.m.m.s.s	Tonne		
VLE Max	50	100	10	10	10	100	10	50	12		850			
Seuil Min.	100	20	20	60	20	20	150	200						
VLE 1/2h	100	20	20	60	20	20	30	200						
01/03/2019	5.14	0.00	0.00	8.18	0.74	87.27	1.132	4.76	19.60	11.37	1001.0	23:50:00		
02/03/2019	10.99	0.08	0.08	8.67	0.76	71.95	1.141	4.17	18.27	11.38	977.6	23:58:50		
03/03/2019	11.84	0.02	0.02	7.99	0.77	87.88	1.123	4.56	18.31	11.23	972.5	17:56:30		
04/03/2019	7.14	0.01	0.01	6.69	0.86	64.26	1.102	4.64	17.13	10.84	977.2	19:17:30		
05/03/2019	10.38	0.01	0.01	8.88	0.88	69.59	1.155	4.33	17.98	11.28	983.5	23:41:50		
06/03/2019	11.21	0.12	0.12	7.56	1.17	65.03	1.148	3.24	19.08	11.50	983.2	23:57:40		
07/03/2019	18.65	0.18	0.18	6.73	1.17	59.49	1.165	3.35	17.54	11.52	978.6	20:32:40		
08/03/2019	9.44	0.09	0.09	7.37	1.16	70.59	1.175	3.68	19.02	11.44	984.2	23:54:40		
09/03/2019	9.91	0.12	0.12	7.01	0.99	74.48	1.153	3.64	18.89	11.48	987.5	23:34:50		
10/03/2019	11.49	0.07	0.07	8.17	0.93	69.42	1.106	4.45	16.97	11.15	975.5	16:39:30		
11/03/2019	Arreté	Arreté	Arreté	Arreté	Arreté	Arreté	Arreté	Arreté	Arreté	Arreté	Arreté	00:00:00		
12/03/2019	Arreté	Arreté	Arreté	Arreté	Arreté	Arreté	Arreté	Arreté	Arreté	Arreté	Arreté	00:00:00		
13/03/2019	24.17	0.38	0.38	4.13	1.19	67.75	1.248	2.92	18.04	11.40	955.7	14:28:10		
14/03/2019	16.87	0.15	0.15	6.90	0.87	68.93	1.218	4.18	18.55	11.66	974.5	22:13:40		
15/03/2019	10.21	0.14	0.14	6.79	0.97	79.90	1.156	3.46	19.00	11.57	994.2	23:10:20		
16/03/2019	13.92	0.18	0.18	7.78	0.85	81.64	1.154	3.08	18.86	11.56	1001.7	23:50:30		
17/03/2019	14.26	0.14	0.14	7.23	0.81	78.24	1.208	3.91	19.06	11.67	995.1	23:27:20		
18/03/2019	6.72	0.11	0.11	6.50	0.75	72.59	1.253	4.32	19.35	11.58	990.1	23:28:50		
19/03/2019	8.23	0.06	0.06	7.68	0.78	76.68	1.218	3.56	18.71	11.61	993.3	21:31:50		
20/03/2019	5.14	0.05	0.05	7.91	0.67	76.68	1.205	4.17	18.50	11.34	1001.3	17:38:30		
21/03/2019	6.92	0.03	0.03	7.12	0.69	81.43	1.216	3.24	19.12	11.50	997.4	23:04:40		
22/03/2019	3.31	0.13	0.13	8.06	0.58	99.12	1.149	3.94	18.78	11.15	1023.7	23:36:30		
23/03/2019	8.03	0.10	0.10	9.56	0.65	75.66	1.238	2.67	18.02	10.64	997.6	14:06:40		
24/03/2019	8.46	0.07	0.07	5.26	0.88	68.30	1.245	3.00	18.42	11.63	993.5	23:04:40		
25/03/2019	5.77	0.06	0.06	7.86	0.89	61.90	1.255	3.30	19.88	11.59	983.5	23:51:40		
26/03/2019	5.46	0.08	0.08	6.52	0.68	69.33	1.212	3.07	19.17	11.78	994.4	23:29:30		
27/03/2019	6.60	0.07	0.07	8.14	0.93	63.89	1.227	2.80	18.78	11.86	982.6	23:53:50		
28/03/2019	11.94	0.17	0.17	7.36	0.91	64.41	1.237	2.55	19.70	11.78	981.1	23:45:00		
29/03/2019	2.88	0.03	0.03	6.87	0.79	67.34	1.152	2.38	19.31	11.43	1004.5	24:00:00		
30/03/2019	3.37	0.18	0.18	7.58	0.62	62.68	1.158	2.46	18.34	11.49	979.2	23:56:20		
31/03/2019	1.18	0.08	0.08	9.10	0.46	79.64	1.139	2.91	17.55	11.34	1012.5	16:05:30		
Max.	24.17	0.38	0.38	9.56	1.19	99.12	1.255	4.76	19.88	11.86	1023.7	101.2		
Min.	1.18	0.00	0.00	4.13	0.46	59.49	1.102	2.38	16.97	10.64	955.7	0.0		
Dep. VLE Jour	0	0	0	0	0	0	0	0	0	0	0	0		
Nb Jour Inva.	0	0	0	0	0	0	0	0	0	0	0	0		
Dep. VLE Max	00:00	00:00	00:00	00:00	00:00	00:00	00:00	00:00	00:00	00:00	00:00	0		
Dep. Seuil Min.														
Dep. VLE 1/2h	8	0	0	0	0	0	0	0	00:00	00:00	00:00	0		
Moy. Mensuelle	9.31	0.10	0.10	7.43	0.83	72.85	1.182	3.54	18.69	11.46	989.2	26j 06:07:30		
% données HG	0.00	0.00	0.00	0.00	0.00	0.00	0.000	0.00	0.00	0.00	0.0	0		
% données HG Annuel	0.00	0.00	0.00	0.00	0.00	0.00	0.000	0.00	0.00	0.00	0.0	0		
Contrôle réglementaire L4 - 2019 (COT)														
Dépassement >4H														
Dep. VLE	00:00	0	0	0	0	0	0	0	00:00	00:00	00:00	0		
Nb jour invalides	0	0	0	0	0	0	0	0	0	0	0	0		
Indis. Cons >10h	0	0	0	0	0	0	0	0	0	0	0	0		
Indisponibilité	00:00	02:30	02:30	00:00	00:00	00:00	00:00	00:00	00:00	00:00	00:00	02:30		

* Le 13/03/2019, dépassement de quatre moyennes 30' en CO à 103.33 mg/Nm3, à 146.39 mg/Nm3, à 139.93 mg/Nm3 (pour une limite à 100) suite à un chargement discontinu du four et à un problème lié aux régulations du four.
* Le 15/03/2019, dépassement d'une moyenne 30' en CO à 124.32 mg/Nm3 (pour une limite à 100) suite à un chargement du four discontinu.
* Le 18/03/2019, dépassement d'une moyenne 30' en CO à 114.81 mg/Nm3 (pour une limite à 100) suite à un chargement du four discontinu.
* Le 24/03/2019, dépassement d'une moyenne 30' en CO à 124.56 mg/Nm3 (pour une limite à 100) suite à un chargement du four discontinu.
* Le 28/03/2019, dépassement d'une moyenne 30' en CO à 110.52 mg/Nm3 (pour une limite à 100) suite à un chargement du four discontinu.



Rapport DREAL Mensuel Ligne 4

Rapport Mensuel														Avril 2019	
Mesure IC95 Lignes1															
Unité	CO	COT	HCL	NES	NOX	POUSSIERE	SO2	Vitesse0_T4_2C	O2	TZS_30_I4	MarcheFouL4_30	Tonnage DASRI			
VLE Jour	mg/Nm3	mg/Nm3	mg/Nm3	mg/Nm3	mg/Nm3	mg/Nm3	mg/Nm3	m/s	%	degreC	hh.mm.ss	Tonne			
VLE Max	50	100	10	10	10	100	10	50			850				
Seuil Min.	100		20	60	20		150	200	12						
VLE 1/2h	100		20	60	20		30								
01/04/2019	5.97		0.05	7.21	0.72	56.97	1.250	4.96	18.77	12.24	974.5	16355.30	119.9		
02/04/2019	5.99		0.11	8.34	0.66	56.74	1.170	3.69	18.12	11.53	975.8	23444.50	0.0		
03/04/2019	8.04		0.19	6.80	0.64	61.85	1.216	3.70	18.77	11.57	971.0	23574.40	0.0		
04/04/2019	6.87		0.58	8.84	0.55	81.84	1.113	7.11	15.65	10.78	1002.8	23111.40	0.0		
05/04/2019	3.97		0.01	8.65	0.58	90.16	1.079	4.48	15.54	10.64	1015.7	23033.30	0.0		
06/04/2019	2.04		0.02	7.78	0.52	90.01	1.123	5.53	17.45	11.29	1010.8	23521.0	0.0		
07/04/2019	1.77		0.17	7.67	0.36	90.53	1.150	8.14	18.70	11.55	1004.7	24000.00	0.0		
08/04/2019	6.74		0.12	6.15	0.58	75.18	1.163	4.11	17.72	11.52	986.5	19144.20	0.0		
09/04/2019	5.97		0.03	7.60	0.55	69.97	4.718	5.47	17.26	11.38	985.6	23543.30	0.0		
10/04/2019	6.83		0.02	8.05	0.59	76.75	1.169	5.15	18.68	11.38	989.4	23563.30	0.0		
11/04/2019	4.42		0.01	7.85	0.56	81.86	1.240	5.79	19.48	11.47	994.7	20444.50	117.7		
12/04/2019	3.58		0.00	8.98	0.49	78.17	1.161	4.81	17.57	11.26	995.8	23201.0	0.0		
13/04/2019	2.18		0.00	9.35	0.49	76.55	1.172	3.84	17.16	11.23	996.3	22082.20	119.9		
14/04/2019	11.18		0.02	7.14	0.67	70.82	1.244	4.85	17.26	11.55	971.9	15161.00	0.0		
15/04/2019	Arret		Arret	Arret	Arret	Arret	Arret	Arret	Arret	Arret	Arret	00:00:00	0.0		
16/04/2019	Arret		Arret	Arret	Arret	Arret	Arret	Arret	Arret	Arret	Arret	00:00:00	0.0		
17/04/2019	Arret		Arret	Arret	Arret	Arret	Arret	Arret	Arret	Arret	Arret	00:00:00	0.0		
18/04/2019	Arret		Arret	Arret	Arret	Arret	Arret	Arret	Arret	Arret	Arret	00:00:00	0.0		
19/04/2019	Arret		Arret	Arret	Arret	Arret	Arret	Arret	Arret	Arret	Arret	00:00:00	0.0		
20/04/2019	Arret		Arret	Arret	Arret	Arret	Arret	Arret	Arret	Arret	Arret	00:00:00	0.0		
21/04/2019	Arret		Arret	Arret	Arret	Arret	Arret	Arret	Arret	Arret	Arret	00:00:00	0.0		
22/04/2019	Arret		Arret	Arret	Arret	Arret	Arret	Arret	Arret	Arret	Arret	00:00:00	0.0		
23/04/2019	Arret		Arret	Arret	Arret	Arret	Arret	Arret	Arret	Arret	Arret	00:00:00	0.0		
24/04/2019	Arret		Arret	Arret	Arret	Arret	Arret	Arret	Arret	Arret	Arret	00:00:00	0.0		
25/04/2019	Arret		Arret	Arret	Arret	Arret	Arret	Arret	Arret	Arret	Arret	00:00:00	0.0		
26/04/2019	Arret		Arret	Arret	Arret	Arret	Arret	Arret	Arret	Arret	Arret	00:00:00	0.0		
27/04/2019	Arret		Arret	Arret	Arret	Arret	Arret	Arret	Arret	Arret	Arret	00:00:00	0.0		
28/04/2019	Arret		Arret	Arret	Arret	Arret	Arret	Arret	Arret	Arret	Arret	00:00:00	0.0		
29/04/2019	Arret		Arret	Arret	Arret	Arret	Arret	Arret	Arret	Arret	Arret	00:00:00	0.0		
30/04/2019	Arret		Arret	Arret	Arret	Arret	Arret	Arret	Arret	Arret	Arret	00:00:00	0.0		
Max.	11.18		0.58	9.35	0.72	90.53	4.718	8.14	19.48	12.24	1015.7		119.9		
Min.	1.77		0.00	6.15	0.36	56.74	1.079	3.69	15.54	10.64	971.0		0.0		
Dep. VLE Jour	0		0	0	0	0	0	0	0	0	0		0		
Nb Jour Inva.	0		0	0	0	0	0	0	0	0	0		0		
Dep. VLE Max	0		00:00	0	0	0	00:00	0	0	0	0		0		
Dep. Seuil Min.	0		0	0	0	0	0	0	00:00	0	00:00		0		
Dep. VLE 1/2h	0		0	0	0	0	0	0	00:00	0	0		0		
Moy. Mensuelle	5.23		0.10	7.93	0.56	75.97	1.518	5.15	17.71	11.36	991.9	1319:20:00	467.5		
% données HG	0.00		0.00	0.00	0.00	0.00	0.000	0.00	0.00	0.00	0.0		0.0		
% données BG	0.00		0.00	0.00	0.00	0.00	0.000	0.00	0.00	0.00	0.0		0.0		
Annuel															
Depassement >H			0												
Dep. VLE	00:00		00:00	10:00	0	00:00	00:00	0	00:00	00:30	00:00		0		
Nb jour invalides	0		0	0	0	0	0	0	0	0	0		1		
Indis. Cons >10h	0		0	0	0	0	0	0	0	0	0		0		
Indisponibilité	00:30		00:30	04:30	0	00:30	00:30	00:30	00:30	00:30	00:30		04:30		

* Le 09/04/2019, dépassement d'une moyenne 30' en Pousssières à 46,886 mg/Nm3 (pour une limite à 30) lors du contrôle réglementaire effectué par la société LECECS.



Rapport DREAL Mensuel Ligne 4

Rapport Mensuel														Mai 2019	
Mesure IC95 Ligne4															
Unités	CO	COT	HCL	NH3	NOX	POUSSIERE	SO2	Vitesse0_T4_2C	O2	T2S_30_L4	MarcheFour_L4_30	Tonnage DASRI			
VLE Jour	mg/Nm3	mg/Nm3	mg/Nm3	mg/Nm3	mg/Nm3	mg/Nm3	mg/Nm3	m/s	%	degreC	hh.mm:ss	Tonne			
VLE Max	100	100	20	10	10	100	10	50			850				
Seuil Min.															
VLE 1/2h	100	100	20	60	20	30	30	200	12						
01/05/2019	Arrêt	Arrêt	Arrêt	Arrêt	Arrêt	Arrêt	Arrêt	Arrêt	Arrêt	Arrêt	Arrêt	00:00:00	0.0		
02/05/2019	Arrêt	Arrêt	Arrêt	Arrêt	Arrêt	Arrêt	Arrêt	Arrêt	Arrêt	Arrêt	Arrêt	00:00:00	0.0		
03/05/2019	Arrêt	Arrêt	Arrêt	Arrêt	Arrêt	Arrêt	Arrêt	Arrêt	Arrêt	Arrêt	Arrêt	00:00:00	0.0		
04/05/2019	Arrêt	Arrêt	Arrêt	Arrêt	Arrêt	Arrêt	Arrêt	Arrêt	Arrêt	Arrêt	Arrêt	00:00:00	0.0		
05/05/2019	Arrêt	Arrêt	Arrêt	Arrêt	Arrêt	Arrêt	Arrêt	Arrêt	Arrêt	Arrêt	Arrêt	00:00:00	0.0		
06/05/2019	Arrêt	Arrêt	Arrêt	Arrêt	Arrêt	Arrêt	Arrêt	Arrêt	Arrêt	Arrêt	Arrêt	00:00:00	0.0		
07/05/2019	19:03	Arrêt	0.38	6.73	1.30	82.58	1.085	4.96	16.99	10.71	946.1	05:00:50	0.0		
08/05/2019	8:41	0.10	0.02	8.47	1.22	66.35	1.244	2.73	19.84	11.48	962.0	23:41:50	0.0		
09/05/2019	6:38	0.00	0.00	7.26	1.32	78.70	1.164	3.85	17.57	11.18	980.1	17:34:10	0.0		
10/05/2019	3:54	0.01	0.00	8.69	1.32	88.56	1.127	3.51	20.19	11.31	983.1	23:46:10	0.0		
11/05/2019	4:12	0.00	0.00	8.04	0.97	83.62	1.172	3.31	20.05	10.99	998.2	21:24:10	0.0		
12/05/2019	8:74	0.05	0.10	7.43	0.88	71.19	1.067	9.01	18.22	11.31	965.6	18:31:10	0.0		
13/05/2019	4:15	0.00	0.00	8.63	0.85	90.49	1.104	3.66	18.69	11.00	961.8	13:02:40	0.0		
14/05/2019	1:11	0.00	0.00	9.07	0.66	98.01	1.083	3.26	17.98	10.86	1002.0	21:06:50	0.0		
15/05/2019	4:46	0.00	0.00	8.87	0.65	74.90	1.160	3.42	18.04	11.24	997.4	23:39:10	0.0		
16/05/2019	2:57	0.00	0.00	8.11	0.65	79.47	1.137	3.34	19.99	11.43	992.6	23:37:10	0.0		
17/05/2019	4:31	0.00	0.04	7.82	0.68	77.48	1.142	3.96	18.15	11.17	997.3	23:28:10	0.0		
18/05/2019	1:57	0.00	0.00	9.30	0.76	79.11	1.093	3.59	16.84	10.63	985.2	23:42:50	0.0		
19/05/2019	3:43	0.05	0.05	8.16	0.65	93.28	1.141	3.73	18.19	11.24	988.1	18:33:00	0.0		
20/05/2019	1:85	0.00	0.00	8.07	0.59	84.37	1.184	3.62	18.67	11.13	1008.2	22:52:00	0.0		
21/05/2019	1:21	0.00	0.00	9.02	0.53	71.56	1.151	3.43	19.63	11.24	994.9	23:25:30	0.0		
22/05/2019	6:86	0.00	0.00	8.36	0.59	85.16	1.159	3.13	19.89	11.33	1011.9	24:00:00	0.0		
23/05/2019	0:86	0.00	0.00	8.97	0.67	86.37	1.183	3.13	20.71	11.44	1009.9	23:58:10	0.0		
24/05/2019	9:16	0.00	0.00	9.16	0.57	93.13	1.143	3.13	19.14	11.26	1020.0	17:40:20	0.0		
25/05/2019	7:40	0.00	0.00	7.40	0.46	67.48	1.167	3.40	18.96	11.39	978.3	16:08:30	0.0		
26/05/2019	2:99	0.00	0.00	9.30	0.49	67.34	1.157	3.39	19.09	11.37	989.0	23:52:20	0.0		
27/05/2019	1:34	0.01	0.00	9.50	0.35	99.56	1.157	3.08	18.72	11.28	1010.4	23:58:40	0.0		
28/05/2019	3:51	0.01	0.00	7.86	0.62	75.63	1.203	2.67	19.95	11.58	1006.7	22:42:00	0.0		
29/05/2019	10:28	0.11	0.11	7.45	0.58	73.68	1.197	2.90	19.20	11.34	994.0	14:12:10	0.0		
30/05/2019	Max.	19.03	0.38	9.50	1.69	99.56	1.244	9.01	20.71	11.58	1023.6	120.6	0.0		
31/05/2019	Min.	0.00	0.00	6.73	0.35	66.35	1.067	2.67	16.84	10.63	946.1	120.6	0.0		
Dep. VLE Jour	0	0	0	0	0	0	0	0	0	0	0	0	0		
Nb Jour Inva.	0	0	0	0	0	0	0	0	0	0	0	0	0		
Dep. VLE Max	00:00	00:00	00:00	00:00	00:00	00:00	00:00	00:00	00:00	00:00	00:00	0	0		
Dep. Seuil Min.															
Dep. VLE 1/2h	5	0	0	0	0	0	0	0	00:00	0	00:00	0	0		
Moy. Mensuelle	5.15	0.03	0.00	8.35	0.77	81.11	1.154	3.56	19.05	11.22	994.5	21j 12:51:30	239.4		
% données HG	0.00	0.00	0.00	0.00	0.00	0.00	0.000	0.00	0.00	0.00	0.0	0	0.0		
% données HG	0.00	0.00	0.00	0.00	0.00	0.00	0.000	0.00	0.00	0.00	0.0	0	0.0		
Annuel															

Contrôle réglementaire L4 - 2019													
CO2													
POUSSIERE													
NOX													
NH3													
HCL													
ICO													
COT													
Depassement >VH													
Dep. VLE	00:00	12:30											
Nb jour invalides	0	00:00											
Indis. Cons >10h	0	0											
Indisponibilité	01:00	05:30											
* Le 13/05/2019, dépassement d'une moyenne 30' en CO à 107,57 mg/Nm3 (pour une limite à 100) suite au redémarrage de la ligne.													
* Le 20/05/2019, dépassement d'une moyenne 30' en CO à 133,85 mg/Nm3 (pour une limite à 100) suite au redémarrage de la ligne.													
* Le 25/05/2019, dépassement d'une moyenne 30' en CO à 106,17 mg/Nm3 (pour une limite à 100) suite à un démarrage du brûleur en PC													
* Le 30/05/2019, dépassement d'une moyenne 30' en CO à 160,67 mg/Nm3 (pour une limite à 100) suite à un chargement discontinu du four.													
* Le 31/05/2019, dépassement d'une moyenne 30' en CO à 100,45 mg/Nm3 (pour une limite à 100) suite à un démarrage de la ligne.													
01/05/2019 04:25													



Rapport DREAL Mensuel Ligne 4

Rapport Mensuel		Mesure IC95 Lignes4										Juin 2019	
CO	Unité	mg/Nm3	COT	HCL	NH3	NOX	POUSSIERE	SO2	Vitesse30_T4_2C	O2	T2S_30_L4	MarcheFourL4_30	Tonnage DASRI
VLE Jour			mg/Nm3	mg/Nm3	mg/Nm3	mg/Nm3	mg/Nm3	mg/Nm3	m/s	%	degreC	hh.mm:ss	Tonne
VLE Max									50				
Seuil Min.									200	12		850	
VLE 1/2h													

01/06/2019	5.69	0.00	0.00	0.00	8.92	0.64	67.68	1.203	2.99	17.04	11.37	985.3	20:56:10
02/06/2019	5.95	0.00	0.00	0.00	8.66	1.04	58.20	3.41	3.41	16.16	10.94	980.9	16:47:00
03/06/2019	5.17	0.26	Invalide	Invalide	Invalide	0.63	77.72	1.148	3.64	19.21	10.99	993.8	17:59:50
04/06/2019	Invalide							Invalide	Invalide	Invalide	Invalide	Invalide	12:23:50
05/06/2019	14.74	0.30	0.00	0.00	7.26	0.59	73.89	1.120	4.76	16.64	11.03	996.0	11:19:20
06/06/2019	1.36	0.00	0.00	0.00	8.85	0.45	91.08	1.165	6.55	20.29	11.58	1017.2	22:54:50
07/06/2019	2.02	0.02	0.08	0.08	10.75	0.43	93.68	1.578	5.98	17.41	10.87	1018.4	22:25:50
08/06/2019	2.91	0.08	0.08	0.06	8.07	0.61	86.44	1.187	5.41	18.48	11.36	1006.0	22:15:40
09/06/2019	3.03	0.06	0.00	0.00	8.07	0.52	90.66	1.214	9.71	20.60	11.93	1010.4	23:42:00
10/06/2019	2.10	0.00	0.00	0.00	9.06	0.62	85.08	1.211	4.68	19.49	11.82	1008.4	23:56:40
11/06/2019	1.46	0.00	0.00	0.00	7.34	0.43	98.17	1.190	7.27	19.97	11.82	1017.2	23:40:50
12/06/2019	3.27	0.01	0.00	0.00	8.19	0.46	73.29	1.177	7.84	17.88	11.62	985.1	23:58:30
13/06/2019	0.99	0.00	0.00	0.00	7.79	0.53	97.47	1.108	6.40	17.90	11.04	1009.4	23:15:30
14/06/2019	2.57	0.02	0.02	0.08	9.15	0.78	74.10	1.192	4.08	20.73	11.89	999.5	23:02:40
15/06/2019	4.44	0.08	0.00	0.00	8.34	0.30	101.14	1.234	7.28	20.17	11.96	1016.2	23:31:50
16/06/2019	2.22	0.00	0.00	0.00	8.13	0.30	89.13	1.223	7.55	20.41	12.15	1006.8	23:10:30
17/06/2019	3.22	0.00	0.00	0.00	9.29	0.42	92.64	1.174	6.00	18.00	11.79	1014.7	19:21:50
18/06/2019	6.48	0.08	0.00	0.00	8.12	0.63	77.72	1.157	3.00	16.92	11.59	1001.0	23:10:20
19/06/2019	2.99	0.00	0.00	0.00	8.60	1.18	94.54	1.101	3.02	16.82	11.14	1017.6	23:10:20
20/06/2019	4.97	0.03	0.00	0.00	8.40	0.84	80.05	1.157	2.78	19.42	11.49	994.8	23:51:10
21/06/2019	5.48	0.00	0.00	0.00	8.00	0.85	68.13	1.095	2.58	18.48	11.07	976.9	23:23:40
22/06/2019	4.21	0.00	0.00	0.00	7.54	0.89	53.38	1.091	2.50	17.75	11.11	984.7	24:00:00
23/06/2019	4.74	0.00	0.00	0.00	7.35	0.83	53.88	1.127	2.58	16.91	11.44	970.3	15:24:20
24/06/2019	19.58	0.10	0.00	0.00	5.19	0.68	71.01	1.182	2.34	15.31	10.80	970.3	15:55:00
25/06/2019	5.94	0.04	0.00	0.00	5.79	0.91	50.45	1.219	2.89	17.22	11.40	982.6	22:44:10
26/06/2019	4.92	0.03	0.03	0.03	7.94	1.19	61.73	1.303	3.69	18.02	11.11	992.9	23:54:00
27/06/2019	7.18	0.01	0.00	0.00	7.17	0.91	63.46	1.182	2.81	16.02	10.97	982.7	21:14:00
28/06/2019	5.02	0.01	0.00	0.00	7.93	0.92	56.11	1.229	3.19	17.75	11.26	991.2	22:45:10
29/06/2019	3.06	0.03	0.00	0.00	8.14	1.11	57.15	1.350	3.24	19.20	11.43	995.6	22:42:20
30/06/2019	1.86	0.00	0.00	0.00	9.12	0.90	52.40	1.181	4.69	18.93	11.43	991.1	17:47:50
Max.	19.58	0.30	0.30	0.30	10.75	1.19	101.14	1.578	9.71	20.73	12.15	1018.4	126.3
Min.	0.99	0.00	0.00	0.00	5.19	0.30	50.45	1.091	2.34	15.31	10.80	964.7	0.0
Dep. VLE jour	0	0	0	0	1	0	1	0	0	0	1	1	0
Nb Jour Inva.	1	1	1	1	1	1	1	1	1	1	1	1	0
Dep. VLE Max	00:00	00:00	00:00	00:00	00:00	00:00	00:00	00:00	00:00	00:00	00:00	00:00	0
Dep. Seuil Min.													
Dep. VLE 1/2h	3	0	0	0	0	0	0	0	0	00:00	00:00	00:00	242.2
Moy. Mensuelle	4.73	0.03	0.00	0.00	8.16	0.70	76.63	1.198	4.63	18.42	11.41	997.8	26j 09:55:10
% données HG	0.00	0.00	0.00	0.00	0.00	0.00	0.00	0.000	0.00	0.00	0.00	0.0	0
% données HG	0.00	0.00	0.00	0.00	0.00	0.00	0.00	0.000	0.00	0.00	0.00	0.0	0
Annuel													

Contrôle réglementaire L4 - 2019										Global	
COI	CO	HCL	NH3	NOX	POUSSIERE	SO2				Global	
Dep. VLE	00:00	14:00	00:00	00:00	00:00	00:30				00:00	
Nb jour invalides	1	1	1	1	1	1				1	
Indis. Cons > 10h	0	0	0	0	0	0				0	
Indisponibilité	06:30	11:30	06:30	06:30	06:30	06:30				06:30	

* Le 03/06/2019, dépassement d'une moyenne 30' en CO à 138.90 mg/Nm3 (pour une limite à 100) suite au redémarrage de la ligne.
 * Le 07/06/2019, dépassement de la valeur moyenne jour en HCL à 10.75 mg/Nm3 (pour un seuil à 10 mg/Nm3) suite à une manque d'injection de chaux dans le filtre à manches (cf Fiche d'incident N°19-002).
 * Le 08/06/2019, dépassement d'une moyenne 30' en CO à 311.15 mg/Nm3 (pour une limite à 100) suite au déclenchement de la séquence 1 d0 à un niveau très haut en cuve de reprise.
 * Le 15/06/2019, dépassement de la valeur moyenne jour en NOx à 101.14 mg/Nm3 (pour un seuil à 100 mg/Nm3), suite à une cadence soutenue sur le four DASRI, une température trop importante en post combustion a provoqué des mesures hautes en NOx (cf Fiche d'incident N°19-004).
 * Le 24/06/2019, dépassement d'une moyenne 30' en CO à 105.3 mg/Nm3 (pour une limite à 100) suite à un défaut du brûleur PC.



Rapport DREAL Mensuel Ligne 4

Rapport Mensuel Juillet 2019

Mesure IC95 Lignes		Moyennes											Tonnage DASRI	
Unité	CO	COT	HCL	NH3	NOX	POUSSIERE	SO2	Vitesse30_T4_2C	O2	T2S_30_L4	MarcheFourLA_30	Tonnage DASRI		
VLE Jour	mg/Nm3	mg/Nm3	mg/Nm3	mg/Nm3	mg/Nm3	mg/Nm3	mg/Nm3	m/s	%	degrec	hh:mm:ss	Tonne		
VLE Max	50	10	10	10	10	100	10	50	12		850			
Seuil Min.	100	20	60	20	20	150	150	200						
VLE 1/2h	100	20	60	20	20	150	150	200						
01/07/2019	5.76	0.02	6.78	1.07	1.07	55.66	1.105	2.75	18.24	11.09	960.4	18 05:40	284.8	
02/07/2019	8.13	0.00	7.07	0.72	0.72	53.56	1.117	2.97	17.03	11.28	953.8	23 33:20	135.0	
03/07/2019	5.41	0.03	7.24	0.55	0.55	58.54	1.099	3.06	17.29	11.19	979.4	23 22:20	137.2	
04/07/2019	2.79	0.01	7.49	0.76	0.76	52.98	1.117	2.87	18.64	11.24	989.3	23 49:20	143.9	
05/07/2019	5.47	0.06	7.65	1.06	1.06	57.30	1.157	2.89	18.59	11.35	985.6	20 51:40	399.7	
06/07/2019	2.56	0.37	6.77	1.13	1.13	59.44	1.201	2.47	18.85	11.40	1007.6	22 02:20	0.0	
07/07/2019	7.35	0.09	5.25	1.27	1.27	39.58	1.168	2.55	19.06	11.69	951.8	23 30:50	0.0	
08/07/2019	11.11	0.00	6.70	0.89	0.89	42.87	1.138	2.43	17.44	11.57	935.1	23 17:20	0.0	
09/07/2019	8.04	0.02	7.04	1.16	1.16	40.37	1.198	2.50	19.20	11.77	957.5	22 35:00	0.0	
10/07/2019	8.36	0.05	7.48	1.03	1.03	45.62	1.129	2.38	19.02	11.33	978.5	18 37:00	0.0	
11/07/2019	3.71	0.02	8.06	1.27	1.27	45.74	1.155	2.40	19.90	11.44	986.0	24 00:00	0.0	
12/07/2019	3.91	0.31	9.05	0.96	0.96	67.73	1.131	2.58	18.66	11.45	992.6	23 23:10	140.9	
13/07/2019	2.17	0.00	7.66	0.80	0.80	58.24	1.126	2.91	18.50	11.37	996.0	23 48:50	0.0	
14/07/2019	2.55	0.02	8.40	0.67	0.67	91.56	1.125	4.07	19.15	11.39	1009.7	10 25:10	0.0	
15/07/2019	9.01	0.02	6.72	0.60	0.60	49.74	1.084	2.57	18.95	11.11	985.3	06 07:20	0.0	
16/07/2019	3.18	0.00	7.66	0.94	0.94	63.79	1.165	3.01	19.95	11.62	1004.4	22 07:00	0.0	
17/07/2019	3.98	0.00	9.10	0.98	0.98	54.58	1.186	3.08	19.59	11.66	993.0	20 45:00	0.0	
18/07/2019	3.76	0.00	8.31	0.90	0.90	65.57	1.155	4.26	18.94	11.63	1000.1	20 55:10	0.0	
19/07/2019	4.01	0.01	7.56	0.95	0.95	78.94	1.128	2.94	19.13	11.22	1009.4	23 55:10	0.0	
20/07/2019	3.20	0.00	8.25	1.13	1.13	55.58	1.160	3.11	20.00	11.51	992.5	23 38:30	0.0	
21/07/2019	4.82	0.00	9.51	0.66	0.66	47.79	1.134	4.12	17.08	11.48	960.4	09 28:30	144.2	
22/07/2019	12.66	0.03	8.56	1.06	1.06	50.64	1.332	2.45	18.82	11.60	982.7	17 02:00	0.0	
23/07/2019	3.43	0.02	9.02	1.11	1.11	57.23	1.608	2.41	17.98	11.47	990.6	23 45:50	0.0	
24/07/2019	4.70	0.18	6.50	1.62	1.62	52.95	1.643	2.46	19.77	11.62	997.9	16 45:50	135.8	
25/07/2019	6.31	0.00	6.55	1.29	1.29	61.56	1.469	3.57	18.18	11.36	993.0	13 04:10	134.1	
26/07/2019	6.01	0.00	6.19	1.30	1.30	64.33	1.229	3.09	18.08	11.48	980.8	21 09:10	118.7	
27/07/2019	8.87	0.00	8.06	1.27	1.27	61.43	1.207	2.87	17.76	11.36	981.9	23 01:50	0.0	
28/07/2019	6.94	0.00	8.44	1.39	1.39	57.42	1.131	3.28	17.58	11.39	988.3	16 18:50	0.0	
29/07/2019	15.89	0.00	6.11	0.76	0.76	70.16	1.033	2.76	13.34	10.53	982.2	06 48:30	0.0	
30/07/2019	9.69	0.00	8.99	1.11	1.11	53.00	1.054	3.53	15.60	10.85	956.1	23 39:00	0.0	
31/07/2019	5.92	0.00	7.09	1.05	1.05	76.13	1.128	3.22	17.61	11.37	985.9	22 21:10	0.0	
Max.	15.89	0.37	9.51	1.62	1.62	91.56	1.643	4.26	20.00	11.77	1009.7		399.7	
Min.	2.17	0.00	5.25	0.55	0.55	39.58	1.033	2.38	13.34	10.53	935.1		0.0	
Nb Jour Inva.	0	0	0	0	0	0	0	0	0	0	0		0	
Dep. VLE jour	0	0	0	0	0	0	0	0	0	0	0		0	
Dep. VLE Max	00:00	00:00	00:00	00:00	00:00	00:00	00:00	00:00	00:00	00:00	00:00		0	
Dep. Seuil Min.														
Dep. VLE 1/2h	5	0	0	0	0	0	0	0	00:00		00:00			
Moy. Mensuelle	6.35	0.04	7.62	1.03	1.03	57.21	1.187	2.92	18.43	11.40	982.4	25j 14:51:10	1774.3	
% données HG	0.00	0.00	0.00	0.00	0.00	0.00	0.000	0.00	0.00	0.00	0.0		0.0	
% données HG	0.00	0.00	0.00	0.00	0.00	0.00	0.000	0.00	0.00	0.00	0.0		0.0	
Annuel														

Contrôle réglementaire L4 - 2019		CO		HCL		NH3		NOX		POUSSIERE		SO2	
Dépassement >4H		0		0		0		0		0		0	
Dép. VLE		16:30		00:00		00:00		00:00		00:30		00:00	
Nb jour invalides		1		1		1		1		1		1	
Indis. Cons >10h		0		0		0		0		0		0	
Indisponibilité		07:30		15:30		07:30		07:30		07:30		07:30	

* Le 01/07/2019, dépassement d'une moyenne 30' en CO à 103,61 mg/Nm3 (pour une limite à 100) suite à la reprise de changement après stock zéro et à une montée trop lente du brûleur PC.
 * Le 02/07/2019, dépassement d'une moyenne 30' en CO à 122,48 mg/Nm3 (pour une limite à 100) suite à un changement discontinu du four due à des défauts de maintenance, et à deux défauts du brûleur PC.
 * Le 06/07/2019, dépassement d'une moyenne 30' en CO à 124,18 mg/Nm3 (pour une limite à 100) lors de la reprise de changement du four.
 * Le 27/07/2019, dépassement de deux moyennes 30' en CO à 185,55 mg/Nm3 et 145,28 (pour une limite à 100) suite à un changement discontinu dû à des défauts sur la manutention.



Rapport DREAL Mensuel Ligne 4

Rapport Mensuel														Aout 2019	
Mesure IC95 Ligné4															
Unité	CO	COT	HCL	NH3	NOX	POUSSIERE	SO2	Vitesse0_14_2C	O2	T2S_30_I4	MarcheFourL4_30	Tonnage DASRI			
VLE Jour	mg/Nm3	mg/Nm3	mg/Nm3	mg/Nm3	mg/Nm3	mg/Nm3	mg/Nm3	m/s	%	degreC	hh.mm:ss	Tonne			
VLE Max	50	100	10	10	10	100	10	50			850				
Seuil Min.	100		20	60	20		150	200	12						
VLE 1/2h	100		20	60	20		30								
01/08/2019	3.58		0.00	8.17	0.92	78.70	1.093	3.20	16.67	10.93	1010.2	22.55:40			
02/08/2019	2.45		0.00	8.14	1.18	83.07	1.095	3.17	17.25	10.92	1020.6	22.51:30			
03/08/2019	2.20		0.00	7.68	0.78	79.60	1.161	3.48	16.97	11.57	1010.0	23:54:50			
04/08/2019	Arrêt		Arrêt	Arrêt	Arrêt	Arrêt	Arrêt	Arrêt	Arrêt	Arrêt	Arrêt	00:19:40			
05/08/2019	7.86		0.04	6.98	0.47	92.51	1.202	4.19	18.40	11.95	992.0	20:17:20			
06/08/2019	5.05		0.01	6.82	0.62	65.75	1.134	3.12	17.39	11.19	998.1	23:34:40			
07/08/2019	5.72		0.02	8.22	0.40	71.64	1.155	3.11	18.31	11.68	998.6	23:34:00			
08/08/2019	2.57		0.00	8.00	0.66	65.57	1.144	3.17	17.28	11.23	992.1	23:29:50			
09/08/2019	4.95		0.00	8.60	0.67	70.41	1.148	3.45	17.21	11.47	993.6	22:00:50			
10/08/2019	3.31		0.02	8.60	0.76	76.03	1.122	2.93	17.78	11.11	1010.1	23:02:30			
11/08/2019	1.20		0.00	9.14	0.47	51.12	1.068	4.02	16.38	10.94	987.2	10:07:10			
12/08/2019	12.10		0.04	8.29	0.55	59.01	0.974	2.14	15.69	9.99	961.5	15:45:00			
13/08/2019	2.37		0.01	8.27	0.65	63.86	0.982	2.27	15.98	10.02	987.6	23:29:40			
14/08/2019	5.61		0.00	8.06	0.62	53.96	0.984	2.52	15.70	10.01	990.2	21:50:10			
15/08/2019	2.51		0.00	7.91	0.74	71.58	0.943	2.72	14.74	9.67	1002.9	17:03:30			
16/08/2019	2.79		0.01	5.93	0.63	59.63	1.119	2.84	18.72	11.26	987.2	20:15:20			
17/08/2019	1.66		0.00	7.83	0.52	53.80	0.946	4.54	14.64	9.83	980.5	03:32:20			
18/08/2019	Arrêt		Arrêt	Arrêt	Arrêt	Arrêt	Arrêt	Arrêt	Arrêt	Arrêt	Arrêt	00:00:00			
19/08/2019	13.60		0.03	9.26	0.53	54.79	1.090	2.93	18.72	10.78	940.2	15:38:00			
20/08/2019	Arrêt		Arrêt	Arrêt	Arrêt	Arrêt	Arrêt	Arrêt	Arrêt	Arrêt	Arrêt	00:00:00			
21/08/2019	Arrêt		Arrêt	Arrêt	Arrêt	Arrêt	Arrêt	Arrêt	Arrêt	Arrêt	Arrêt	00:00:00			
22/08/2019	Arrêt		Arrêt	Arrêt	Arrêt	Arrêt	Arrêt	Arrêt	Arrêt	Arrêt	Arrêt	00:00:00			
23/08/2019	Arrêt		Arrêt	Arrêt	Arrêt	Arrêt	Arrêt	Arrêt	Arrêt	Arrêt	Arrêt	00:00:00			
24/08/2019	Arrêt		Arrêt	Arrêt	Arrêt	Arrêt	Arrêt	Arrêt	Arrêt	Arrêt	Arrêt	00:00:00			
25/08/2019	Arrêt		Arrêt	Arrêt	Arrêt	Arrêt	Arrêt	Arrêt	Arrêt	Arrêt	Arrêt	00:00:00			
26/08/2019	Arrêt		Arrêt	Arrêt	Arrêt	Arrêt	Arrêt	Arrêt	Arrêt	Arrêt	Arrêt	00:00:00			
27/08/2019	Arrêt		Arrêt	Arrêt	Arrêt	Arrêt	Arrêt	Arrêt	Arrêt	Arrêt	Arrêt	00:00:00			
28/08/2019	Arrêt		Arrêt	Arrêt	Arrêt	Arrêt	Arrêt	Arrêt	Arrêt	Arrêt	Arrêt	00:00:00			
29/08/2019	Arrêt		Arrêt	Arrêt	Arrêt	Arrêt	Arrêt	Arrêt	Arrêt	Arrêt	Arrêt	00:00:00			
30/08/2019	Arrêt		Arrêt	Arrêt	Arrêt	Arrêt	Arrêt	Arrêt	Arrêt	Arrêt	Arrêt	00:00:00			
31/08/2019	Arrêt		Arrêt	Arrêt	Arrêt	Arrêt	Arrêt	Arrêt	Arrêt	Arrêt	Arrêt	00:00:00			
Max.	13.60		0.04	9.26	1.18	92.51	1.202	4.54	18.72	11.95	1020.6				
Min.	1.20		0.00	5.93	0.40	51.12	0.943	2.14	14.64	9.67	940.2				
Nb Jour Inva.	0		0	0	0	0	0	0	0	0	0				
Dep. VLE Jour	0		0	0	0	0	0	0	0	0	0				
Dep. VLE Max	00:00		00:00	00:00	00:00	00:00	00:00	00:00	00:00	00:00	00:00				
Dep. Seuil Min.															
Dep. VLE 1/2h	3		0	0	0	0	0	0	00:00		00:00				
May. Mensuelle	5.12		0.01	7.83	0.68	69.36	1.092	3.08	17.09	10.95	994.3	13j 21:42:00			
% données HG	0.00		0.00	0.00	0.00	0.00	0.000	0.00	0.00	0.00	0.0				
% données HG	0.00		0.00	0.00	0.00	0.00	0.000	0.00	0.00	0.00	0.0				
Annuel															

* Le 05/08/2019, dépassement de 2 moyennes 30' en CO à 126.40 mg/Nm3 et à 104.17 (pour une limite à 100) suite à un chargement discontinu du four.
 * Le 16/08/2019, dépassement d'une moyenne 30' en CO à 109.56 (pour une limite à 100) suite à un chargement irrégulier du four.

Rapport DREAL Mensuel Ligne 4

Rapport Mensuel														Septembre 2019	
Mesure IC95 Ligné4															
Unité	CO	COT	HCL	NH3	NOX	POUSSIERE	SO2	Vitesse0_T4_2C	O2	T2S_30_J4	MarcheFourL4_30	Tonnage DASRI			
VLE Jour	mg/Nm3	mg/Nm3	mg/Nm3	mg/Nm3	mg/Nm3	mg/Nm3	mg/Nm3	m/s	%	degréC	hh mm:ss	Tonne			
VLE Max	100	100	20	10	10	100	10	50			850				
Seuil Min.															
VLE 1/2h	100	100	20	60	20	30	30	2000	12						
01/09/2019	Arrêt	Arrêt	Arrêt	Arrêt	Arrêt	Arrêt	Arrêt	Arrêt	Arrêt	Arrêt	Arrêt	00:00:00	0.0		
02/09/2019	Arrêt	Arrêt	Arrêt	Arrêt	Arrêt	Arrêt	Arrêt	Arrêt	Arrêt	Arrêt	Arrêt	00:00:00	0.0		
03/09/2019	Arrêt	Arrêt	Arrêt	Arrêt	Arrêt	Arrêt	Arrêt	Arrêt	Arrêt	Arrêt	Arrêt	00:00:00	0.0		
04/09/2019	Indisponible											00:00:00	281.6		
05/09/2019	Arrêt	Arrêt	Arrêt	Arrêt	Arrêt	Arrêt	Arrêt	Arrêt	Arrêt	Arrêt	Arrêt	00:00:00	0.0		
06/09/2019	Arrêt	Arrêt	Arrêt	Arrêt	Arrêt	Arrêt	Arrêt	Arrêt	Arrêt	Arrêt	Arrêt	00:00:00	0.0		
07/09/2019	Arrêt	Arrêt	Arrêt	Arrêt	Arrêt	Arrêt	Arrêt	Arrêt	Arrêt	Arrêt	Arrêt	00:00:00	0.0		
08/09/2019	Arrêt	Arrêt	Arrêt	Arrêt	Arrêt	Arrêt	Arrêt	Arrêt	Arrêt	Arrêt	Arrêt	00:00:00	0.0		
09/09/2019	3.77	0.20	5.81	8.92	2.76	69.27	0.929	23.76	16.52	9.28	975.6	08:14:50	0.0		
10/09/2019	2.62	0.07	7.09	8.92	2.76	69.27	0.929	23.76	16.52	9.28	990.5	23:25:30	0.0		
11/09/2019	6.26	0.07	7.09	8.92	2.76	69.27	0.929	23.76	16.52	9.28	953.9	18:30:30	0.0		
12/09/2019	3.21	0.08	6.71	8.92	2.76	69.27	0.929	23.76	16.52	9.28	975.2	19:24:20	0.0		
13/09/2019	Arrêt	Arrêt	Arrêt	Arrêt	Arrêt	Arrêt	Arrêt	Arrêt	Arrêt	Arrêt	Arrêt	00:00:00	0.0		
14/09/2019	4.87	0.01	6.21	8.92	2.76	69.27	0.929	23.76	16.52	9.28	961.2	23:29:00	0.0		
15/09/2019	5.05	0.07	8.36	8.92	2.76	69.27	0.929	23.76	16.52	9.28	951.0	18:07:40	0.0		
16/09/2019	16.79	0.06	6.50	8.92	2.76	69.27	0.929	23.76	16.52	9.28	956.0	16:23:40	124.9		
17/09/2019	3.06	0.00	8.30	8.92	2.76	69.27	0.929	23.76	16.52	9.28	986.6	23:10:50	337.3		
18/09/2019	4.53	0.00	8.30	8.92	2.76	69.27	0.929	23.76	16.52	9.28	981.1	23:09:30	0.0		
19/09/2019	7.43	0.09	6.84	8.92	2.76	69.27	0.929	23.76	16.52	9.28	968	16:33:40	0.0		
20/09/2019	7.07	0.02	7.48	8.92	2.76	69.27	0.929	23.76	16.52	9.28	965.2	23:34:30	0.0		
21/09/2019	3.42	0.00	8.01	8.92	2.76	69.27	0.929	23.76	16.52	9.28	973.1	23:50:40	0.0		
22/09/2019	4.69	0.18	6.90	8.92	2.76	69.27	0.929	23.76	16.52	9.28	959.6	19:08:00	0.0		
23/09/2019	5.84	0.07	8.75	8.92	2.76	69.27	0.929	23.76	16.52	9.28	954.6	17:37:10	0.0		
24/09/2019	8.59	0.07	8.59	8.92	2.76	69.27	0.929	23.76	16.52	9.28	957.2	22:25:40	0.0		
25/09/2019	4.32	0.06	9.17	8.92	2.76	69.27	0.929	23.76	16.52	9.28	967.2	22:38:40	160.1		
26/09/2019	4.67	0.16	8.08	8.92	2.76	69.27	0.929	23.76	16.52	9.28	975.2	23:11:40	134.4		
27/09/2019	3.35	0.02	8.17	8.92	2.76	69.27	0.929	23.76	16.52	9.28	979.5	23:47:30	134.6		
28/09/2019	3.36	0.00	8.96	8.92	2.76	69.27	0.929	23.76	16.52	9.28	954.4	23:10:30	0.0		
29/09/2019	5.95	0.07	8.53	8.92	2.76	69.27	0.929	23.76	16.52	9.28	942.8	13:13:20	0.0		
30/09/2019	10.69	0.02	9.06	8.92	2.76	69.27	0.929	23.76	16.52	9.28	969.4	16:14:00	0.0		
Max.	16.79	0.20	9.17	8.92	2.76	69.27	1.250	23.76	17.11	10.22	990.5	337.3	0.0		
Min.	2.62	0.00	5.81	8.92	2.76	69.27	0.923	2.20	14.89	9.28	942.8	0.0	0.0		
Dep. VLE jour	0	0	0	0	0	0	0	0	0	0	0	0	0		
Nb Jour Inva.	1	0	0	0	0	0	0	0	0	0	0	0	0		
Dep. VLE Max	00:00	00:00	00:00	00:00	00:00	00:00	00:00	00:00	00:00	00:00	00:00	00:00	0		
Dep. Seuil Min.															
Dep. VLE 1/2h	1	0	0	0	0	0	0	0	00:00	0	00:00	0	0		
Moy. Mesurelle	5.62	0.05	7.91	8.92	2.76	69.27	0.994	3.74	16.76	9.69	967.6	17j 11:21:10	1172.9		
% données HG	0.00	0.00	0.00	0.00	0.00	0.00	0.000	0.00	0.00	0.00	0.0	0	0.0		
% données HG	0.00	0.00	0.00	0.00	0.00	0.00	0.000	0.00	0.00	0.00	0.0	0	0.0		
Annuel															

* Le 19/09/2019, dépassement d'une moyenne 30' en CO à 115,59 mg/Nm3 (pour une limite à 100) suite à la reprise de chargement après une intervention de maintenance et à une montée trop lente du brûleur PC.

Rapport DREAL Mensuel Ligne 4

Octobre 2019

Rapport Mensuel													
Mesure IC95 Lignes4													
	CO	COT	HCL	NB3	NOX	POUSSIERE	SO2	Vitesse10_T4_2C	O2	T2S_30_L4	MarcheFourL4_30	Tonnage DASRI	
Unité	mg/Nm3	mg/Nm3	mg/Nm3	mg/Nm3	mg/Nm3	mg/Nm3	10/150/30	m/s	%	degreC	hh:mm:ss	Tonne	
VLE Jour	50		10	10	10	100		50			850		
VLE Max	100		20	10	10		150						
Seuil Min.													
VLE 1/2h	100		20	60	20	30		200	12				
01/10/2019	3.03	0.06	8.98	9.30	1.66	61.27	0.964	3.75	16.90	9.85	979.8	23:19:40	0.0
02/10/2019	2.74	0.00	7.42	9.30	2.13	61.79	0.986	3.90	17.84	9.83	985.9	23:30:40	0.0
03/10/2019	2.72	0.00	7.42	9.30	2.03	59.39	1.047	3.48	17.78	10.35	958.3	18:02:50	0.0
04/10/2019	2.86	0.00	8.88	9.30	1.77	60.35	0.989	2.88	18.22	9.91	970.0	23:49:00	0.0
05/10/2019	5.52	0.00	9.06	9.30	1.04	61.60	0.966	3.19	15.70	9.79	977.3	23:51:20	0.0
06/10/2019	5.23	0.01	8.83	9.30	0.91	67.53	1.267	3.89	13.63	10.09	958.4	19:16:40	0.0
07/10/2019	7.38	0.00	7.81	9.30	1.25	65.04	1.041	3.98	15.68	10.12	964.4	19:57:10	0.0
08/10/2019	6.04	0.02	8.40	9.30	0.99	58.77	1.008	3.44	15.50	9.87	971.7	23:04:40	0.0
09/10/2019	12.14	0.06	6.62	9.30	1.05	59.31	1.233	3.26	15.21	10.19	961.4	20:13:00	0.0
10/10/2019	4.78	0.00	9.10	9.30	1.27	62.30	1.007	3.74	16.36	9.86	992.4	15:06:10	0.0
11/10/2019	Arrêt	Arrêt	Arrêt	Arrêt	Arrêt	Arrêt	Arrêt	Arrêt	Arrêt	Arrêt	Arrêt	00:00:00	276.1
12/10/2019	Arrêt	Arrêt	Arrêt	Arrêt	Arrêt	Arrêt	Arrêt	Arrêt	Arrêt	Arrêt	Arrêt	00:00:00	0.0
13/10/2019	Arrêt	Arrêt	Arrêt	Arrêt	Arrêt	Arrêt	Arrêt	Arrêt	Arrêt	Arrêt	Arrêt	00:00:00	0.0
14/10/2019	Arrêt	Arrêt	Arrêt	Arrêt	Arrêt	Arrêt	Arrêt	Arrêt	Arrêt	Arrêt	Arrêt	00:00:00	273.2
15/10/2019	Arrêt	Arrêt	Arrêt	Arrêt	Arrêt	Arrêt	Arrêt	Arrêt	Arrêt	Arrêt	Arrêt	00:00:00	0.0
16/10/2019	45.93	0.14	4.70	9.30	1.14	74.31	0.877	2.24	15.53	8.22	966.5	01:47:30	0.0
17/10/2019	10.74	0.10	9.45	9.30	1.38	64.79	1.091	3.53	15.32	9.58	946.2	23:37:40	0.0
18/10/2019	3.70	0.00	3.70	9.30	1.33	74.80	1.044	3.67	16.55	9.94	981.9	24:00:00	0.0
19/10/2019	4.05	0.01	8.82	9.30	1.69	72.59	1.039	3.77	17.68	9.94	980.0	22:57:50	0.0
20/10/2019	33.06	0.10	3.50	9.30	1.05	70.45	1.041	2.78	17.42	10.31	935.1	03:03:20	0.0
21/10/2019	9.33	0.00	9.97	9.30	1.73	69.53	0.802	3.21	18.85	10.25	974.4	22:58:50	0.0
22/10/2019	3.75	0.00	7.62	9.30	1.87	64.17	0.287	2.14	17.76	9.60	997.1	22:26:30	0.0
23/10/2019	4.72	0.00	10.42	9.30	1.29	65.12	0.272	1.27	17.37	9.57	994.5	21:48:40	0.0
24/10/2019	4.71	0.02	10.13	9.30	1.39	63.71	0.279	2.32	16.33	9.68	989.0	23:25:50	0.0
25/10/2019	2.62	0.00	7.33	9.30	1.31	65.01	0.268	1.79	17.15	9.59	989.8	23:18:10	0.0
26/10/2019	2.92	0.09	7.33	9.30	1.10	62.47	0.270	3.19	16.81	9.45	1001.3	22:38:50	0.0
27/10/2019	2.77	0.03	7.74	9.30	1.10	66.80	0.276	2.47	13.87	9.41	983.1	18:01:30	0.0
28/10/2019	5.94	0.04	7.50	9.30	1.64	66.80	0.270	2.47	16.67	9.60	987.3	17:24:40	0.0
29/10/2019	5.71	0.03	7.31	9.30	1.87	67.58	0.270	2.27	17.78	9.45	992.7	20:33:30	0.0
30/10/2019	6.74	0.06	9.07	9.30	1.63	64.61	0.270	2.17	17.96	9.44	984.0	22:21:30	0.0
31/10/2019	6.31	0.05	9.01	9.30	1.83	65.35	0.275	2.03	19.30	9.52	977.4	23:41:10	0.0
Max.	45.93	0.14	10.42	3.59	2.13	74.80	1.267	3.98	19.50	10.35	1001.3	276.1	0.0
Min.	2.62	0.00	3.59	2	0.91	57.53	0.268	1.27	13.63	8.22	935.1	0.0	0.0
Dep. VLE Jour	0	0	0	0	0	0	0	0	0	0	0	0	0
Nb Jour Iva.	0	0	0	0	0	0	0	0	0	0	0	0	0
Dep. VLE Max	00:00	00:00	00:00	00:00	00:00	00:00	00:00	00:00	00:00	00:00	00:00	0	0
Dep. Seuil Min.													
Dep. VLE 1/2h	2	0	0	0	0	0	1	0	00:00	9.77	978.9	21j 20:17:00	549.3
Moy. Mensuelle	5.74	0.03	8.66	0.00	1.51	64.30	0.757	2.93	16.82	9.77	978.9	0	0.0
% données HG	0.00	0.00	0.00	0.00	0.00	0.00	0.000	0.00	0.00	0.00	0.0	0	0.0
% données HG Annuel	0.00	0.00	0.00	0.00	0.00	0.00	0.000	0.00	0.00	0.00	0.0	0	0.0

Contrôle réglementaire L4 - 2019													
	CO	HCL	NB3	NOX	POUSSIERE	SO2	Global						
Dep. VLE	00:00	19:30	00:00	00:00	00:00	01:00	00:00	00:00	01:00	00:00	00:00	0	0
Nb jour invalides	1	2	1	1	1	1	1	1	1	1	1	1	2
Indis. Cons >10h													
Disponibilité	08:00	16:30	08:00	08:00	08:00	08:00	08:00	08:00	08:00	08:00	08:00	08:00	16:30

* Le 06/10/2019, dépasement d'une moyenne 30' en poussières à 43.03 mg/Nm3 (pour une limite à 30) suite à une détection de niveau haut matière dans le FAM
* Le 20/10/2019, dépasement d'une moyenne 30' en CO à 100.7 mg/Nm3 (pour une limite à 100) suite à la reprise de chargement après un stock 0 et à une montée trop lente du brûleur PC.
* Le 23/10/2019, dépasement de la moyenne journalière en HCl de la ligne DAS à 10,42 mg/Nm3 (pour un seuil à 10 mg/Nm3), suite au bouchage de la tuyauterie d'injection de chaux éteinte au niveau du filtre à manches (cf. Fiche d'incident N°19-011).
* Le 25/10/2019, dépasement de la moyenne journalière en HCl de la ligne DAS à 10,13 mg/Nm3 (pour un seuil à 10 mg/Nm3), suite au bouchage de la tuyauterie d'injection de chaux éteinte au niveau du filtre à manches cf. Fiche d'incident N°19-013).
* Le 28/10/2019, dépasement d'une moyenne 30' en CO à 168.73 mg/Nm3 (pour une limite à 100) suite à la perte du brûleur PC lors de la reprise de chargement après un stock 0.

Rapport DREAL Mensuel Ligne 4

Novembre 2019

Rapport Mensuel		Mesure IC95 Ligne4													Tonnage DASRI	
CO		CO	HCL	NH3	NOX	POUSSIERE	SO2	Vitesse30_T4_2C	O2	T2S_30_J4	MarcheFornL4_30	Tonnage DASRI				
Unité	mg/Nm3	mg/Nm3	mg/Nm3	mg/Nm3	mg/Nm3	mg/Nm3	mg/Nm3	m/s	%	degreC	hh:mm:ss	Tonne				
VLE Jour	50	10	10	10	10	100	10	50			150					
VLE Max	100	20	20	20	20	100	150	200	12		150					
Seuil Min.																
VLE 1/2h	100	20	60	60	20	30	30									
01/11/2019	4.92	0.05	10.55	1.78	62.08	0.608	18.39	1.44	9.42	9.42	979.9	22:49:20	0.0			
02/11/2019	8.23	0.12	7.95	0.99	63.52	0.270	17.32	2.21	9.40	9.40	964.6	14:04:40	0.0			
03/11/2019	14.98	0.01	9.19	1.40	69.16	0.324	15.09	1.91	11.28	11.28	937.4	05:38:20	0.0			
04/11/2019	20.18	0.25	8.98	1.15	61.86	0.309	15.44	1.70	10.67	10.67	930.3	15:38:20	0.0			
05/11/2019	6.53	0.01	11.46	0.92	64.07	0.277	15.23	1.88	9.55	9.55	970.7	23:22:20	0.0			
06/11/2019	5.58	0.00	8.01	0.94	64.32	0.271	14.84	1.19	9.37	9.37	984.9	23:17:50	0.0			
07/11/2019	4.27	0.00	9.81	1.32	62.30	0.287	17.56	1.27	9.44	9.44	985.8	22:50:40	0.0			
08/11/2019	4.66	0.00	8.23	1.10	63.83	0.308	15.76	1.27	9.49	9.49	978.6	22:34:20	0.0			
09/11/2019	8.39	0.00	7.43	1.33	63.61	0.292	16.32	1.37	9.60	9.60	968.8	23:05:30	0.0			
10/11/2019	6.80	0.00	7.43	1.22	63.26	0.292	15.69	1.40	9.45	9.45	973.1	19:20:30	0.0			
11/11/2019	Arrêt	Arrêt	Arrêt	Arrêt	Arrêt	Arrêt	Arrêt	Arrêt	Arrêt	Arrêt	Arrêt	00:00:00	0.0			
12/11/2019	Arrêt	Arrêt	Arrêt	Arrêt	Arrêt	Arrêt	Arrêt	Arrêt	Arrêt	Arrêt	Arrêt	00:00:00	0.0			
13/11/2019	Arrêt	Arrêt	Arrêt	Arrêt	Arrêt	Arrêt	Arrêt	Arrêt	Arrêt	Arrêt	Arrêt	00:00:00	292.5			
14/11/2019	18.65	0.13	3.17	1.17	64.02	0.297	17.07	0.82	9.42	9.42	951.9	18:36:50	0.0			
15/11/2019	3.27	0.00	5.34	0.84	62.35	0.368	17.91	1.02	9.81	9.81	954.2	24:00:00	0.0			
16/11/2019	3.32	0.00	8.56	0.88	63.14	0.313	17.47	0.96	9.82	9.82	963.2	24:00:00	0.0			
17/11/2019	2.42	0.00	8.26	0.74	60.02	0.307	16.70	0.97	9.79	9.79	973.9	08:04:40	0.0			
18/11/2019	7.86	0.03	6.29	0.42	60.56	0.308	18.23	0.55	9.71	9.71	963.8	18:50:50	0.0			
19/11/2019	2.70	0.00	8.84	0.56	60.46	0.387	18.69	0.78	9.89	9.89	957.0	21:06:30	0.0			
20/11/2019	8.14	0.00	8.76	0.52	59.44	0.314	17.20	0.99	9.51	9.51	1003.7	23:34:10	0.0			
21/11/2019	3.66	0.00	9.73	0.81	62.34	0.300	17.59	0.90	9.48	9.48	992.5	23:23:50	0.0			
22/11/2019	2.30	0.01	8.10	0.81	58.00	0.275	17.58	1.06	9.33	9.33	992.5	23:30:10	0.0			
23/11/2019	2.14	0.00	9.33	0.69	64.55	0.294	18.80	1.06	9.48	9.48	1001.2	23:30:10	0.0			
24/11/2019	1.71	0.00	7.65	0.36	62.55	0.277	16.36	0.94	9.48	9.48	992.6	23:37:20	0.0			
25/11/2019	3.82	0.00	9.13	0.57	62.44	0.268	17.19	1.31	9.37	9.37	982.7	17:58:00	0.0			
26/11/2019	1.98	0.00	8.98	0.69	66.76	0.276	18.88	0.78	9.64	9.64	990.2	17:58:00	0.0			
27/11/2019	2.27	0.00	7.46	0.49	61.13	0.281	17.61	0.68	9.87	9.87	980.2	22:54:50	0.0			
28/11/2019	2.15	0.00	8.27	0.63	63.41	0.276	17.61	0.68	9.82	9.82	991.3	23:43:50	0.0			
29/11/2019	2.60	0.00	8.93	0.51	67.35	0.286	17.75	0.68	9.88	9.88	981.6	24:00:00	0.0			
30/11/2019	1.74	0.00	9.69	0.56	65.89	0.305	19.03	0.66	9.69	9.69	995.9	24:00:00	0.0			
Max.	20.18	0.25	11.46	1.78	69.16	0.608	19.03	11.40	11.28	11.28	1003.7	24:00:00	292.5			
Min.	1.71	0.00	3.17	0.36	58.00	0.268	14.84	0.55	9.33	9.33	930.3		0.0			
Dep. VLE jour	0	0	2	0	0	0	0	0	0	0	0	0	0			
Nb Jour Iva.	0	0	0	0	0	0	0	0	0	0	0	0	0			
Dep. VLE Max	00:00	00:00	0	0	0	00:00	00:00	0	0	0	0	0	0			
Dep. Seuil Min.																
Dep. VLE 1/2h	10	0	0	0	63.00	0.311	17.30	1.44	9.65	9.65	977.1	23:08:57:20	292.5			
Moy. Mensuelle	6.18	0.02	8.46	0.85	63.00	0.300	0.00	0.00	0.00	0.00	0.0	0	0.0			
% données HG	0.00	0.00	0.00	0.00	0.00	0.00	0.00	0.00	0.00	0.00	0.0	0	0.0			
% données HG	0.00	0.00	0.00	0.00	0.00	0.00	0.00	0.00	0.00	0.00	0.0	0	0.0			
Annuel																

Contrôle réglementaire L4 - 2019		CO	HCL	NH3	NOX	POUSSIERE	SO2	Global	
Dépassement >4H		0	0	0	0	0	0	0	0
Dép. VLE		00:00	24:30	00:00	00:00	00:00	01:00	00:00	25:30
Nb jour invalides		1	2	1	1	1	1	1	2
Indis. Cons >10h		0	0	0	0	0	0	0	0
Indisponibilité		08:00	16:30	08:00	08:00	08:00	08:00	08:00	16:30

* Le 01/11/2019, dépassement de la moyenne journalière en HCl de la ligne DAS à 10,55 mg/Nm3 (pour un seuil à 10 mg/Nm3), suite à nouveau bouchage de l'injection de chaux (cf. Fiche d'incident N° 19-014).
 * Le 02/11/2019, dépassement d'une moyenne 30' en CO à 114,17 mg/Nm3 (pour une limite à 100) lors de la reprise de chargement après un stock 0.
 * Le 04/11/2019, dépassement de 3 moyennes 30' en CO à 137,61, 120,4 et 140,83 mg/Nm3 (pour une limite à 100) lors de reprise de chargement après une intervention sur l'enfournement.
 * Le 05/11/2019, dépassement de la moyenne journalière en HCl de la ligne DAS à 11,46 mg/Nm3 (pour un seuil à 10 mg/Nm3), suspicion de fuite sur l'échangeur Fumées/Fumées (pas de bouchage chaux constaté) (cf. Fiche d'incident N°19-015).
 * Le 10/11/2019, dépassement d'une moyenne 30' en CO à 104,49 mg/Nm3 (pour une limite à 100) lors de reprise de chargement après une intervention sur la guilloine et foulon enfournement.
 * Le 14/11/2019, dépassement de 4 moyennes 30' en CO à 153,65, 138,16, 101,83 et 104,85 mg/Nm3 (pour une limite à 100) lors de reprise de chargement après un arrêt de ligne.
 * Le 18/11/2019, dépassement d'une moyenne 30' en CO à 177,07 mg/Nm3 (pour une limite à 100) lors de la reprise du chargement.

Rapport DREAL Mensuel Ligne 4

Decembre 2019

Rapport Mensuel

Mesure IC95 Lignes4

Unité	mg/Nm3	CO	mg/Nm3	HCL	mg/Nm3	NHB	mg/Nm3	NOX	mg/Nm3	POUSSIERE	mg/Nm3	SO2	mg/Nm3	Vitesse10_T4_2C	m/s	O2	%	T2S_30_L4	degreC	Tonnage DASRI	Tome	MarcheFourL4_30	Ih:mm:ss
01/12/2019	3.48	0.00	0.00	0.00	7.09	0.52	74.35	0.316	17.91	9.83	997.8	22.21.40	0.0										
02/12/2019	2.20	0.01	9.16	0.75	71.19	0.312	65.51	0.319	18.96	9.75	990.7	23.37.10	0.0										
03/12/2019	2.12	0.00	9.64	0.83	7.96	0.314	66.00	0.347	19.00	9.78	992.0	23.44.50	0.0										
04/12/2019	2.70	0.00	7.96	0.96	7.99	0.314	66.00	0.347	17.61	9.69	970.1	21.43.30	0.0										
05/12/2019	4.40	0.00	7.99	1.30	9.23	0.328	74.02	0.328	18.70	9.82	987.4	22.42.30	0.0										
06/12/2019	1.66	0.00	9.17	1.08	6.41	0.283	69.57	0.283	18.63	9.80	1018.0	23.32.30	0.0										
07/12/2019	1.83	0.02	6.41	1.16	8.48	0.297	60.50	0.297	16.69	9.90	977.0	23.52.20	0.0										
08/12/2019	5.82	0.00	8.21	1.07	9.32	0.317	64.77	0.317	15.68	9.91	970.6	18.26.20	0.0										
09/12/2019	8.21	0.00	9.22	0.99	9.22	0.310	63.22	0.310	16.39	9.71	992.6	21.26.40	0.0										
10/12/2019	2.72	0.00	8.78	1.48	77.46	0.326	77.46	0.326	17.65	9.76	992.6	23.42.30	0.0										
11/12/2019	3.41	0.00	8.78	1.83	9.18	0.305	90.84	0.305	19.12	9.94	997.4	23.20.30	0.0										
12/12/2019	5.88	0.02	9.22	1.29	83.16	0.285	71.75	0.285	18.51	9.88	1017.2	22.46.30	0.0										
13/12/2019	6.97	0.00	7.20	0.63	99.50	0.284	76.46	0.284	17.78	9.68	1026.7	21.19.00	0.0										
14/12/2019	1.69	0.00	8.48	0.58	8.48	0.268	76.46	0.268	16.02	9.67	1029.7	23.48.50	0.0										
15/12/2019	1.95	0.00	8.48	0.87	8.68	0.270	72.46	0.270	17.86	9.60	1049.7	14.04.50	0.0										
16/12/2019	8.43	0.02	8.68	0.80	9.50	0.284	72.46	0.284	17.21	9.69	999.3	16.23.00	0.0										
17/12/2019	3.58	0.00	8.78	0.80	8.50	0.271	65.16	0.271	16.04	9.65	1009.0	22.56.00	0.0										
18/12/2019	2.65	0.00	8.78	1.25	8.50	0.277	73.12	0.277	16.03	9.82	990.2	23.17.00	0.0										
19/12/2019	3.77	0.00	8.50	1.25	8.50	0.300	71.75	0.300	17.77	9.80	1015.9	23.58.00	0.0										
20/12/2019	4.21	0.00	8.50	0.87	8.20	0.297	73.28	0.297	14.37	9.78	1018.5	24.00.00	0.0										
21/12/2019	2.33	0.01	8.25	0.42	7.45	0.275	71.92	0.275	15.00	9.66	1022.0	15.17.10	0.0										
22/12/2019	1.68	0.02	8.56	0.96	8.11	0.274	69.73	0.274	14.95	9.63	1011.6	16.57.30	0.0										
23/12/2019	4.52	0.01	8.56	0.96	8.11	0.272	69.83	0.272	15.00	9.66	1011.6	16.57.30	0.0										
24/12/2019	2.72	0.01	8.56	0.71	4.80	0.294	62.40	0.294	14.94	9.66	1015.6	23.53.10	0.0										
25/12/2019	2.25	0.00	4.80	1.57	6.69	0.265	64.68	0.265	14.27	9.64	1000.2	23.17.40	0.0										
26/12/2019	8.28	0.03	4.07	1.07	6.69	0.284	68.21	0.284	14.72	9.76	1003.5	17.52.10	0.0										
27/12/2019	5.95	0.00	6.09	0.69	8.52	0.321	63.53	0.321	16.10	9.79	1001.7	00.00.00	0.0										
28/12/2019	5.19	0.03	8.52	0.69	8.20	0.317	74.73	0.317	15.40	9.64	1001.7	18.54.50	0.0										
29/12/2019	5.13	0.50	8.20	0.91	8.20	0.347	99.50	0.347	19.12	10.05	1049.7	23.05.10	0.0										
30/12/2019	4.24	0.21	9.64	0.42	4.07	0.265	60.50	0.265	14.27	9.60	970.1	23.05.10	0.0										
31/12/2019	8.43	0.50	0.00	0.00	0.00	0.00	0.00	0.00	0.00	0.00	0.00	0.00	0.0										
Max.	8.43	0.50	9.64	1.83	9.64	0.347	99.50	0.347	19.12	10.05	1049.7	23.05.10	0.0										
Min.	1.66	0.00	4.07	0.42	4.07	0.265	60.50	0.265	14.27	9.60	970.1	23.05.10	0.0										
Dep. VLE jour	0	0	0	0	0	0	0	0	0	0	0	0	0										
Nb jour inva.	0	0	0	0	0	0	0	0	0	0	0	0	0										
Dep. VLE Max	0	0	0	0	0	0	0	0	0	0	0	0	0										
Dep. Sentil Min.	00:00	00:00	00:00	00:00	00:00	00:00	00:00	00:00	00:00	00:00	00:00	00:00	00:00										
Dep. VLE 1/2h	11	0	0	0	0	0	0	0	0	0	0	0	0										
Moy. Mensuelle	4.83	0.03	8.22	0.95	8.22	0.297	71.41	0.297	16.90	9.77	1004.9	26j 12:36:30	0.0										
% données HG	0.00	0.00	0.00	0.00	0.00	0.000	0.00	0.000	0.00	0.00	0.0	0	0.0										
% données HG	0.00	0.00	0.00	0.00	0.00	0.000	0.00	0.000	0.00	0.00	0.0	0	0.0										
Annuel																							

Dépassement >H	CO	HCL	NH3	NOX	POUSSIERE	SO2	Global
Dep. VLE	00:00	30:00	00:00	00:00	00:00	01:00	31:50
Nb jour invalides	1	3	1	1	1	1	3
Indis. Cons >10h	0	0	0	0	0	0	0
Indisponibilité	08:00	16:30	08:00	08:00	08:00	08:00	16:30

* Le 05/12/2019, dépassement d'une moyenne 30' en CO à 123.2 mg/Nm3 (pour une limite à 100) consécutif à plusieurs arrêts de ligne maintenance.
 * Le 08/12/2019, dépassement d'une moyenne 30' en CO à 103.94 mg/Nm3 (pour une limite à 100) consécutif à la reprise du chargement suite à un arrêt pour nettoyage et contrôle sortie four.
 * Le 16/12/2019, dépassement de deux moyennes 30' en CO à 104.85 mg/Nm3 et à 102.65 mg/Nm3 (pour une limite à 100) lors de la reprise du chargement.
 * Le 22/12/2019, dépassement d'une moyenne 30' en CO à 101.34 mg/Nm3 (pour une limite à 100) suite à un arrêt de chargement sur un blocage piston enfouissement.
 * Le 23/12/2019, dépassement d'une moyenne 30' en CO à 107.49 mg/Nm3 (pour une limite à 100) suite à une reprise de chargement après stock 0.
 * Le 25/12/2019, dépassement d'une moyenne 30' en CO à 112.46 mg/Nm3 (pour une limite à 100) suite à un arrêt intempêtif de la chaîne de manutention.
 * Le 26/12/2019, dépassement d'une moyenne 30' en CO à 128.28 mg/Nm3 (pour une limite à 100) suite à une reprise de chargement après stock 0.
 * Le 30/12/2019, dépassement de trois moyennes 30' en CO à 172.17 mg/Nm3, 126.66 mg/Nm3 et à 119 mg/Nm3 (pour une limite à 100) lors de la reprise du chargement après stock 0 et un chargement discontinu.

The first part of the document discusses the importance of maintaining accurate records of all transactions. It emphasizes that every entry, no matter how small, should be recorded to ensure the integrity of the financial statements. This includes not only sales and purchases but also expenses and income. The document further explains that proper record-keeping is essential for identifying trends, managing cash flow, and complying with tax regulations.

In addition, the document highlights the need for regular reconciliation of accounts. By comparing the company's internal records with bank statements and other external sources, discrepancies can be identified and corrected promptly. This process helps prevent errors from accumulating and ensures that the financial data is reliable and up-to-date.

The second part of the document focuses on the classification of assets and liabilities. It provides a detailed breakdown of how different types of assets, such as property, equipment, and inventory, should be valued and reported. Similarly, it outlines the methods for classifying liabilities, including short-term debt and long-term obligations. The document stresses that accurate classification is crucial for providing a clear picture of the company's financial position and for making informed decisions about future investments and financing.

Finally, the document concludes by discussing the role of the auditor in verifying the accuracy of the financial statements. It explains that an independent audit provides an objective assessment of the company's financial health and helps to build confidence among investors and other stakeholders. The document also provides guidance on how to prepare for an audit and how to address any findings or recommendations.

Date	Du 25/12/2018 au 23/01/2019	Du 23/01/2019 au 19/02/2019	Du 19/02/2019 au 19/03/2019	Du 19/03/2019 au 16/04/2019	Du 16/04/2019 au 14/05/2019	Du 14/05/2019 au 11/06/2019	Du 11/06/2019 au 09/07/2019	Du 09/07/2019 au 08/08/2019	Du 08/08/2019 au 03/09/2019	Du 03/09/2019 au 01/10/2019	Du 01/10/2019 au 29/10/2019	Du 29/10/2019 au 26/11/2019	Du 26/11/2019 au 23/12/2019
Prélèvement	AMESA	AMESA	AMESA	AMESA	AMESA	AMESA	AMESA	AMESA	AMESA	AMESA	AMESA	AMESA	AMESA
Analyse	Dioxlab	Dioxlab	Dioxlab	Dioxlab	Dioxlab	Dioxlab	Dioxlab	Dioxlab	Dioxlab	Dioxlab	Dioxlab	Dioxlab	Dioxlab
Données générales													
Durée de la période	s	3,97480	3,87738	4,00377	3,99464	3,99712	4,00188	3,99831	3,99365	4,00238	3,98869	4,00159	3,84375
Durée de prélèvement	h	383,18	448,08	562,13	545,85	133,87	588,35	515,40	206,67	431,13	364,62	491,35	534,60
Durée de fonctionnement de l'installation	h	388,4	452,7	565,4	576,8	134,1	591,7	618,8	526,1	433,7	455,3	510,6	590,3
Indisponibilité du système de prélèvement	%	1,3%	1,0%	0,6%	5,4%	0,2%	0,8%	16,7%	60,7%	0,6%	19,9%	3,8%	9,4%
Indisponibilité du système de prélèvement depuis début d'année	%	1,3%	1,2%	0,9%	2,2%	2,1%	1,8%	4,5%	12,2%	10,5%	11,4%	10,6%	10,5%
Volume des fumées rejetées sur la période de prélèvement	Nm ³ sec	8 028 079	10 218 671	11 363 219	11 018 807	2 716 195	11 624 095	9 924 738	6 927 646	7 320 803	6 291 892	8 464 239	9 190 988
Débit horaire moyen des fumées rejetées sur la période de prélèvement	Nm ³ sec/h	20672	22571	20097	19104	20258	19644	16040	13169	16882	13619	16579	15570
Volume prélevé	Nm ³ sec	320,317	407,264	452,815	439,550	108,429	463,484	396,276	81,476	291,920	251,677	339,578	365,966
Débit prélèvement sur sec	Nm ³ sec/h	0,84	0,91	0,81	0,81	0,81	0,79	0,77	0,39	0,68	0,69	0,69	0,68
O ₂	%	10,90	10,70	11,00	11,20	10,80	11,00	11,00	10,90	9,40	9,50	9,40	9,60
H ₂ O	g/m ³	33,30	39,30	33,60	32,70	31,90	34,80	31,90	57,80	134,00	30,30	31,30	29,70
Ratio volume rejetés/prélevé		25062,92	25091,02	25094,62	25068,38	25050,45	25079,82	25045,01	85026,83	25078,11	24999,87	24925,76	25114,32
Ratio volume/durée de prélèvement	m ³ /h	0,84	0,91	0,81	0,81	0,81	0,79	0,77	0,39	0,68	0,69	0,69	0,68
Teneur en PCDD/F @11% O₂ sur gaz sec													
Teneur en PCDD/F sur brut	ng/Nm ³	0,012	0,029	0,009	0,019	0,016	0,021	0,014	0,074	0,055	0,117	0,045	0,050
Teneur en PCDD/F en I-TEQ	ng _{I-TEQ} /Nm ³	0,001	0,002	0,001	0,001	0,001	0,002	0,001	0,006	0,006	0,0097	0,004	0,003
Flux de PCDD/F													
Flux de PCDD/F en I-TEQ	mg	0,007	0,022	0,008	0,016	0,003	0,018	0,011	0,040	0,045	0,061	0,037	0,026
Flux de PCDD/F en I-TEQ cumulé	mg	0,007	0,029	0,037	0,054	0,057	0,075	0,085	0,126	0,166	0,246	0,284	0,310

COMMENTAIRES :

...the ... of ...

...the ... of ...

...the ... of ...

...the ... of ...

...the ... of ...

...the ... of ...

...the ... of ...

...the ... of ...

...the ... of ...

...the ... of ...

...the ... of ...

...the ... of ...

...the ... of ...

...the ... of ...

...the ... of ...

...the ... of ...

...the ... of ...

...the ... of ...

3.4. Effluents



Rapport Rejet AQ Mensuel

Rapport Mensuel Janvier 2019

Rejet Liquide		Ph	Volume Ph Inf/Dep	Temp Ph Inf/Dep	Temp Ph Sup/Dep	Température	Volume Température	Temp Température	Turbidité	Volume Turbidi	Temp Turbidi	Temp Turbidi	Volume CO2	Temp CO2	Marche Rejet	Volume Rejet
Unité	Seuil Jour		Inf	Sup	Sup	degréC	m3	hh:mm:ss	mg/l	m3	hh:mm:ss	hh:mm:ss	Dep.	Dep.	hh:mm:ss	m3
Dép.	Seuil Min		hh:mm:ss	hh:mm:ss	hh:mm:ss											
01/01/2019	10.07	8.5	00:00:00	00:00:00	00:00:00	23.63	30	00:00:00	600	5.13	00:00:00	00:00:00	3.27	00:00:00	24:00:00	241.93
02/01/2019	10.95	5.5	00:00:00	00:00:00	00:00:00	23.52	0	00:00:00	0	3.54	00:00:00	00:00:00	2.76	00:00:00	24:00:00	263.02
03/01/2019	9.54	6.35	00:43:30	00:00:00	00:00:00	23.53	0	00:00:00	0	2.98	00:00:00	00:00:00	2.30	00:00:00	24:00:00	229.29
04/01/2019	10.96	6.83	00:00:00	00:00:00	00:00:00	23.59	0	00:00:00	0	2.59	00:01:10	00:00:00	2.99	00:00:00	24:00:00	263.96
05/01/2019	9.29	6.91	00:00:00	00:00:00	00:00:00	23.21	0	00:00:00	0	1.60	00:00:00	00:00:00	3.18	00:00:00	24:00:00	222.79
06/01/2019	8.26	6.60	00:00:00	00:00:00	00:00:00	23.59	0	00:00:00	0	2.15	00:00:00	00:00:00	3.86	00:00:00	24:00:00	198.00
07/01/2019	8.64	7.62	03:18:50	00:00:00	08:21:30	23.01	0	00:00:00	0	8.08	00:00:00	00:00:00	25.48	04:53:40	24:00:00	208.06
08/01/2019	12.55	7.08	00:00:00	00:00:00	00:00:00	23.33	0	00:00:00	0	6.20	00:00:00	00:00:00	4.46	00:00:00	24:00:00	300.91
09/01/2019	10.51	6.81	00:00:00	00:00:00	00:00:00	23.61	0	00:00:00	0	5.60	00:00:00	00:00:00	4.04	00:52:40	24:00:00	252.81
10/01/2019	9.49	6.56	00:00:00	00:00:00	00:00:00	23.64	0	00:00:00	0	12.96	00:00:00	00:00:00	3.37	00:00:00	24:00:00	227.76
11/01/2019	9.59	6.94	00:00:00	00:00:00	00:00:00	23.47	0	00:00:00	0	11.84	00:00:00	00:00:00	1.39	00:00:00	24:00:00	230.65
12/01/2019	10.12	7.56	00:14:10	00:00:00	01:03:30	23.74	0	00:00:00	0	7.28	00:00:00	00:00:00	0.46	00:00:00	24:00:00	243.38
13/01/2019	10.31	6.92	00:00:00	00:00:00	00:00:00	24.41	0	00:00:00	0	6.18	00:00:00	00:00:00	0.06	00:00:00	24:00:00	247.00
14/01/2019	8.39	7.06	00:00:00	00:00:00	00:00:00	23.69	0	00:00:00	0	8.11	00:00:00	00:00:00	2.57	00:00:00	24:00:00	200.95
15/01/2019	11.53	6.58	02:11:00	00:00:00	00:00:00	24.08	0	00:00:00	0	8.61	00:00:00	00:00:00	3.60	00:00:00	24:00:00	277.07
16/01/2019	10.83	6.46	00:00:00	00:00:00	00:00:00	23.68	0	00:00:00	0	6.77	00:00:00	00:00:00	8.32	01:20:00	24:00:00	260.29
17/01/2019	11.07	6.53	00:00:00	00:00:00	00:00:00	24.65	0	00:00:00	0	5.60	00:00:00	00:00:00	8.12	00:26:10	24:00:00	265.84
18/01/2019	10.68	6.34	00:00:00	00:00:00	00:00:00	25.44	0	00:00:00	0	6.79	00:00:00	00:00:00	8.51	00:00:00	24:00:00	256.64
19/01/2019	7.53	5.99	00:00:00	00:00:00	00:00:00	26.32	0	00:00:00	0	7.01	00:17:40	00:00:00	6.63	00:00:00	24:00:00	180.91
20/01/2019	9.01	6.25	00:00:00	00:00:00	00:00:00	28.16	0	09:23:50	13.95	13.95	00:00:00	00:00:00	6.82	00:00:00	24:00:00	216.61
21/01/2019	7.80	6.53	00:00:00	00:00:00	00:00:00	26.31	0	03:41:30	12.14	12.14	00:00:00	00:00:00	5.37	00:00:00	24:00:00	187.00
22/01/2019	9.43	6.26	00:00:00	00:00:00	00:00:00	26.40	0	00:44:20	10.48	10.48	00:00:00	00:00:00	6.07	00:26:40	24:00:00	226.61
23/01/2019	8.23	6.98	00:00:00	00:00:00	00:00:00	22.43	0	00:00:00	15.59	15.59	00:00:00	00:00:00	7.89	00:52:50	24:00:00	197.66
24/01/2019	7.58	7.35	00:09:20	00:00:00	00:42:50	21.15	0	00:00:00	10.19	10.19	00:00:00	00:00:00	12.26	00:53:30	24:00:00	182.10
25/01/2019	9.11	7.21	00:00:00	00:00:00	00:00:00	21.56	0	01:53:50	4.80	4.80	00:00:00	00:00:00	8.33	00:00:00	24:00:00	218.50
26/01/2019	10.33	7.32	00:00:00	00:00:00	00:00:00	20.43	0	00:00:00	7.13	7.13	00:00:00	00:00:00	10.72	00:00:00	24:00:00	247.99
27/01/2019	9.00	7.06	00:00:00	00:00:00	00:00:00	22.38	0	00:00:00	5.72	5.72	00:00:00	00:00:00	8.26	00:00:00	24:00:00	216.03
28/01/2019	9.45	6.78	00:00:00	00:00:00	00:00:00	21.54	0	00:36:40	12.10	12.10	00:00:00	00:00:00	23.10	04:14:00	24:00:00	226.97
29/01/2019	8.10	7.28	00:00:00	00:00:00	00:00:00	19.37	0	01:43:40	6.09	6.09	00:00:00	00:00:00	7.35	00:00:00	24:00:00	194.57
30/01/2019	12.15	7.26	00:00:00	00:00:00	00:00:00	20.95	0	00:00:00	7.47	7.47	00:00:00	00:00:00	11.44	00:00:00	25:55:00	290.61
31/01/2019	11.00	7.00	00:00:00	00:00:00	00:00:00	20.95	0	00:00:00	4.57	4.57	00:00:00	00:00:00	8.98	00:00:00	24:00:00	264.35
Max.	12.55	7.62	00:00:00	00:00:00	00:00:00	28.16	0	00:00:00	15.59	15.59	00:00:00	00:00:00	25.48	00:00:00	24:00:00	300.91
Min.	7.53	5.99	00:00:00	00:00:00	00:00:00	19.37	0	00:00:00	4.80	4.80	00:00:00	00:00:00	6.06	00:00:00	24:00:00	180.91
Dep. Seuil Jour																
Nb Jour Inval.	0	0	0	0	0	0	0	0	0	0	0	0	0	0	0	0
Dep. Seuil Min	9.23	6.83	03:05:02	00:00:00	00:00:00	14.00	0	00:00:00	7.40	7.40	00:00:00	00:00:00	6.79	00:00:00	23:50:00	72.40.26
Moy./Jou.						23.42		14:07:20	113.94	113.94	14:07:20	14:07:20	6.79	13:59:30	300	23:50:00



Rapport Rejet AQ Mensuel

Rapport Mensuel Février 2019

Unité Scalé Jour Scalé Max Dép. Scalé Min	Ph	Volume Ph		Temp Ph Inf. Dép	Temp Ph Sup. Dép	Volume Ph Sup. Dép	Temp Ph Sup. Dép	Température	Volume Température	Temp Température Dép.	Turbidité	Volume/Turbidité	Temp Dép.	Temp Turbidité Dép.	COI	Volume COI Dép.	Temp COI Dép.	Marchés/Rejets	Volume Rejet
		Inf. Dép	Sup. Dép																
8.5 5.5		0.00	0.00	0.00	0.00	0.00	0.00	0.00	30	0.00	0.00	0.00	0.00	0.00	0.00	0.00	01:19:10	24:00:00	279.73
11.64	6.96	0.00	0.00	0.00	0.00	0.00	0.00	21.43	0.00	0.00	0.00	0.00	0.00	0.00	0.00	0.00	00:00:00	24:00:00	262.31
10.94	6.66	0.00	0.00	0.00	0.00	0.00	0.00	22.11	0.00	0.00	0.00	0.00	0.00	0.00	0.00	0.00	00:00:00	24:00:00	242.25
10.07	6.30	0.00	0.00	0.00	0.00	0.00	0.00	23.09	0.00	0.00	0.00	0.00	0.00	0.00	0.00	0.00	00:00:00	24:00:00	251.69
10.49	6.18	0.00	0.00	0.00	0.00	0.00	0.00	21.99	0.00	0.00	0.00	0.00	0.00	0.00	0.00	0.00	00:00:00	24:00:00	283.17
11.81	7.01	0.00	0.00	0.00	0.00	0.00	0.00	22.36	0.00	0.00	0.00	0.00	0.00	0.00	0.00	0.00	00:00:00	24:00:00	262.67
10.92	7.25	0.00	0.00	0.00	0.00	0.00	0.00	21.77	0.00	0.00	0.00	0.00	0.00	0.00	0.00	0.00	00:00:00	24:00:00	336.56
14.02	7.16	0.00	0.00	0.00	0.00	0.00	0.00	22.76	0.00	0.00	0.00	0.00	0.00	0.00	0.00	0.00	00:00:00	24:00:00	217.22
9.14	6.84	0.00	0.00	0.00	0.00	0.00	0.00	24.42	0.00	0.00	0.00	0.00	0.00	0.00	0.00	0.00	00:00:00	24:00:00	288.10
12.00	7.06	0.00	0.00	0.00	0.00	0.00	0.00	24.03	0.00	0.00	0.00	0.00	0.00	0.00	0.00	0.00	00:00:00	24:00:00	274.94
11.46	6.99	0.00	0.00	0.00	0.00	0.00	0.00	24.06	0.00	0.00	0.00	0.00	0.00	0.00	0.00	0.00	00:00:00	24:00:00	254.54
10.58	6.70	0.00	0.00	0.00	0.00	0.00	0.00	23.62	0.00	0.00	0.00	0.00	0.00	0.00	0.00	0.00	00:00:00	24:00:00	250.85
10.45	6.71	0.00	0.00	0.00	0.00	0.00	0.00	22.53	0.00	0.00	0.00	0.00	0.00	0.00	0.00	0.00	00:00:00	24:00:00	293.31
13/02/2019	6.73	0.00	0.00	0.00	0.00	0.00	0.00	22.74	0.00	0.00	0.00	0.00	0.00	0.00	0.00	0.00	00:00:00	24:00:00	238.17
14/02/2019	6.96	0.55	0.00	0.00	0.00	0.00	0.00	23.03	0.00	0.00	0.00	0.00	0.00	0.00	0.00	0.00	00:00:00	24:00:00	220.70
15/02/2019	9.18	7.55	0.00	0.00	0.00	0.00	0.00	22.23	0.00	0.00	0.00	0.00	0.00	0.00	0.00	0.00	00:00:00	24:00:00	178.74
16/02/2019	7.46	6.99	0.00	0.00	0.00	0.00	0.00	22.41	0.00	0.00	0.00	0.00	0.00	0.00	0.00	0.00	00:00:00	24:00:00	211.44
17/02/2019	8.86	7.55	0.00	0.00	0.00	0.00	0.00	23.18	0.00	0.00	0.00	0.00	0.00	0.00	0.00	0.00	00:00:00	24:00:00	273.66
18/02/2019	11.40	7.01	0.00	0.00	0.00	0.00	0.00	23.28	0.00	0.00	0.00	0.00	0.00	0.00	0.00	0.00	00:00:00	24:00:00	256.07
19/02/2019	10.67	6.97	0.00	0.00	0.00	0.00	0.00	23.50	0.00	0.00	0.00	0.00	0.00	0.00	0.00	0.00	00:00:00	24:00:00	270.71
20/02/2019	11.28	8.21	3.93	0.00	0.00	0.00	0.00	22.47	0.00	0.00	0.00	0.00	0.00	0.00	0.00	0.00	00:00:00	24:00:00	197.16
21/02/2019	8.20	7.39	7.03	0.00	0.00	0.00	0.00	23.34	0.00	0.00	0.00	0.00	0.00	0.00	0.00	0.00	00:00:00	24:00:00	310.70
22/02/2019	12.98	7.62	0.00	0.00	0.00	0.00	0.00	22.75	0.00	0.00	0.00	0.00	0.00	0.00	0.00	0.00	00:00:00	24:00:00	228.24
23/02/2019	9.42	7.45	0.00	0.00	0.00	0.00	0.00	23.79	0.00	0.00	0.00	0.00	0.00	0.00	0.00	0.00	00:00:00	24:00:00	288.64
24/02/2019	12.03	7.53	1.88	0.00	0.00	0.00	0.00	23.30	0.00	0.00	0.00	0.00	0.00	0.00	0.00	0.00	00:00:00	24:00:00	251.91
25/02/2019	10.51	7.40	4.34	0.00	0.00	0.00	0.00	23.43	0.00	0.00	0.00	0.00	0.00	0.00	0.00	0.00	00:00:00	24:00:00	288.70
26/02/2019	12.03	7.32	0.00	0.00	0.00	0.00	0.00	23.58	0.00	0.00	0.00	0.00	0.00	0.00	0.00	0.00	00:00:00	24:00:00	309.34
27/02/2019	12.88	7.25	0.00	0.00	0.00	0.00	0.00	23.65	0.00	0.00	0.00	0.00	0.00	0.00	0.00	0.00	00:00:00	24:00:00	246.80
28/02/2019	10.28	6.83	0.00	0.00	0.00	0.00	0.00	24.68	0.00	0.00	0.00	0.00	0.00	0.00	0.00	0.00	00:00:00	24:00:00	336.56
Max	14.02	8.21	7.03	0.00	0.00	0.00	0.00	24.68	0.00	0.00	0.00	0.00	0.00	0.00	0.00	0.00	00:00:00	24:00:00	178.74
Min	7.46	6.18	0.00	0.00	0.00	0.00	0.00	21.43	0.00	0.00	0.00	0.00	0.00	0.00	0.00	0.00	00:00:00	24:00:00	0
Dép. Scalé Jour Nb Jour Inva.	0	0	0	0	0	0	0	0	0	0	0	0	0	0	0	0	0	0	0
Dép. Scalé Max Dép. Scalé Min Moy./Tot.	10.82	7.89	17.73	07:45:00	02:02	05:21:30	00:00	23.05	0.00	0.00	11.51	17.73	02:03:10	10.13	156.87	14:30:10	27:23:42:10	7366.32	



Rapport Rejet AQ Mensuel

Rapport Mensuel										Mars 2019								
Dép. Seuil Min	Unité Seuil Jour Seuil Max	Débit m3/h	Ph	Volume Ph Inf/Dép.		Temp Ph Sup/Dép.		Température		Turbidité mg/l	Volume Turbidité m3	Temp Turbidité		Volume COT	Temp COT		Volume Rejet	
				m3	hh:mm:ss	Sup/Dép.	hh:mm:ss	DegréC	m3			hh:mm:ss	hh:mm:ss		Dep.	hh:mm:ss		Dep.
8.5	5.5							30		600								
01/03/2019		10.70		0.00	00:22:50	1.56	00:00:00	24.65	0.00	00:00:00	0.00	00:00:00	00:00:00	31.85	05:53:30	24:00:00	256.82	
02/03/2019		12.14		0.00	00:13:30	1.44	00:00:00	24.31	0.00	00:00:00	0.00	00:00:00	00:00:00	27.15	04:57:20	24:00:00	291.31	
03/03/2019		11.30		0.00	00:13:20	2.44	00:00:00	24.22	0.00	00:00:00	0.00	00:00:00	00:00:00	21.49	02:40:20	24:00:00	271.16	
04/03/2019		10.18		0.00	00:57:10	7.46	00:00:00	23.76	0.00	00:00:00	0.00	00:00:00	00:00:00	18.68	01:19:50	24:00:00	244.53	
05/03/2019		10.18		0.12	03:11:40	27.79	00:55:50	23.76	0.00	00:00:00	0.12	00:00:40	00:00:00	23.25	01:49:40	23:53:00	209.22	
06/03/2019		10.96		0.00	00:00:00	1.87	00:00:00	23.82	0.00	00:00:00	0.00	00:00:00	00:00:00	11.44	00:00:00	24:00:00	263.27	
07/03/2019		12.81		0.00	00:07:00	0.00	00:00:00	23.58	0.00	00:00:00	0.00	00:00:00	00:00:00	12.62	01:47:30	24:00:00	307.72	
08/03/2019		10.56		0.00	00:00:00	0.00	00:01:00	24.16	0.00	00:00:00	0.00	00:00:00	00:00:00	4.78	00:00:00	24:00:00	253.60	
09/03/2019		11.01		0.00	00:00:00	0.00	00:01:40	24.10	0.00	00:00:00	0.00	00:00:00	00:00:00	4.28	00:00:00	24:00:00	264.57	
10/03/2019		9.80		0.00	00:00:00	0.00	00:00:00	24.54	0.00	00:00:00	0.00	00:00:00	00:00:00	4.91	00:00:00	24:00:00	235.70	
11/03/2019		9.82		0.00	00:00:00	0.00	01:26:20	23.85	0.00	00:00:00	0.00	00:00:00	00:00:00	6.24	00:00:00	24:00:00	265.70	
12/03/2019		8.76		0.00	00:00:10	0.02	09:26:50	22.66	0.00	00:00:00	0.00	00:00:00	00:00:00	16.69	02:12:10	24:00:00	210.16	
13/03/2019		10.96		0.00	00:00:00	0.00	00:32:10	22.05	0.00	00:00:00	0.00	00:00:00	00:00:00	9.36	00:00:00	24:00:00	263.15	
14/03/2019		13.08		0.00	00:00:00	0.00	00:00:00	21.83	0.00	00:00:00	0.00	00:00:00	00:00:00	7.65	00:00:00	24:00:00	313.99	
15/03/2019		10.13		1.35	01:20:00	18.53	00:00:00	23.82	0.00	00:00:00	21.40	00:20:40	00:00:00	13.76	02:00:10	24:00:00	243.97	
16/03/2019		11.10		0.00	00:00:00	0.00	00:00:00	24.25	0.00	00:00:00	5.77	00:00:00	00:00:00	4.80	00:00:00	24:00:00	266.13	
17/03/2019		8.73		0.00	00:03:20	1.02	00:01:00	24.48	0.00	00:00:00	5.64	00:00:00	00:00:00	3.81	00:00:00	24:00:00	209.42	
18/03/2019		10.85		0.00	00:00:00	0.00	00:55:00	23.27	0.00	00:00:00	7.42	00:00:00	00:00:00	5.58	00:00:00	24:00:00	260.53	
19/03/2019		10.71		0.00	00:01:00	0.16	00:01:20	22.73	0.00	00:00:00	9.94	00:00:00	00:00:00	3.99	00:26:40	23:57:00	256.32	
20/03/2019		10.64		0.00	00:00:00	0.00	00:00:00	23.60	0.00	00:00:00	12.49	00:00:00	00:00:00	1.73	00:00:00	24:00:00	255.11	
21/03/2019		11.67		0.00	01:23:20	10.77	00:00:00	23.53	0.00	00:00:00	12.79	00:00:00	00:00:00	3.22	00:00:00	24:00:00	280.29	
22/03/2019		10.28		0.00	00:00:00	0.00	00:00:00	23.94	0.00	00:00:00	12.89	00:00:00	00:00:00	2.79	00:00:00	24:00:00	247.38	
23/03/2019		11.84		0.00	00:00:00	0.00	00:00:00	24.68	0.00	00:00:00	12.75	00:00:00	00:00:00	2.24	00:00:00	24:00:00	284.52	
24/03/2019		10.45		0.00	00:00:00	0.00	00:00:00	23.95	0.00	00:00:00	12.18	00:00:00	00:00:00	0.71	00:00:00	24:00:00	251.13	
25/03/2019		12.75		0.26	00:00:00	0.00	00:00:00	22.59	0.00	00:00:00	13.40	00:00:50	00:00:00	0.00	00:00:00	24:00:00	284.52	
26/03/2019		13.82		0.00	00:00:00	0.00	00:00:00	22.52	0.00	00:00:00	14.54	00:00:00	00:00:00	13.25	02:10:20	24:00:00	306.76	
27/03/2019		13.57		0.00	00:00:00	0.00	00:09:50	22.67	0.00	00:00:00	14.54	00:00:00	00:00:00	28.89	05:47:20	24:00:00	331.67	
28/03/2019		11.74		0.00	00:06:30	0.92	00:53:50	24.09	0.00	00:00:00	7.28	00:00:00	00:00:00	5.66	00:52:50	24:00:00	325.62	
29/03/2019		12.57		0.00	00:00:00	0.00	00:00:00	25.39	0.00	00:00:00	9.71	00:00:00	00:00:00	5.25	01:02:20	24:00:00	282.26	
30/03/2019		10.74		0.00	00:00:00	0.00	00:00:00	25.71	0.00	00:00:00	3.23	00:00:00	00:00:00	3.71	00:26:10	24:00:00	301.56	
31/03/2019		9.89		0.00	00:00:00	0.00	00:00:00	25.42	0.00	00:00:00	7.23	00:00:00	00:00:00	2.57	00:00:00	24:00:00	257.87	
Max.		13.82		1.35		27.79		25.71	0.32		21.40	1.35		31.85		23:00:00	331.67	
Min.		8.73		0.00		0.00		21.83	0.00		3.23	0.00		0.71			209.22	
Dép. Seuil Jour		0		0	0	0	0	0	0	0	0	0	0	0	0	0	0	
Nb Jour Inva.		0		0	0	0	0	0	0	0	0	0	0	0	0	0	0	
Dép. Seuil Max		11.05		1.73	07:59:50	73.98		00:07			8.61	1.73		10.33	11:12:05:30	309:22:50:00	8206.41	
Dép. Seuil Min		05:24						23.80	0.32	00:02:10								
Moy./Jour		6.95		1.73				23.80	0.32	00:02:10								



Rapport Rejet AQ Mensuel

Rapport Mensuel

Avril 2019

Rejet Liquide		Ph	Volume Ph Inf/Dep	Temp Ph Inf/Dep	Volume Ph Step/Dep	Temp Ph Sup/Dep	Temperature	Volume Temperature	Temp Temperature	Turbidité	Volume Turbid/Temp Turbidité	Temp Turbid/Dep	Volume COT	Temp COT	Marche Rejets	Volume Rejet	
Unité	Seuil Jour	Seuil Max	m3	hh:mm:ss	m3	hh:mm:ss	degreC	m3	hh:mm:ss	mg/l	m3	hh:mm:ss	mg/l	hh:mm:ss	hh:mm:ss	m3	
Dep.	Seuil Min		8.5		30					600	40						
01/04/2019	11.06	6.36	0.00	00:00:00	0.00	00:00:00	25.49	0.00	00:00:00	9.98	0.00	00:00:00	4.87	0.00	00:00:00	23:53:00	264.19
02/04/2019	9.84	6.11	0.00	00:00:00	0.00	00:00:00	24.59	0.00	00:00:00	19.60	0.00	00:00:00	3.24	0.00	00:00:00	24:00:00	236.51
03/04/2019	10.11	6.54	0.00	02:31:40	20.86	00:05:50	23.93	0.00	00:00:00	16.05	0.00	00:00:00	3.51	0.00	00:00:00	24:00:00	242.30
04/04/2019	9.97	6.36	0.26	06:26:50	54.34	00:57:30	23.91	0.00	00:00:00	9.99	0.26	00:02:00	2.59	0.00	00:00:00	24:00:00	239.13
05/04/2019	10.08	7.47	0.00	00:00:20	0.02	00:00:00	22.98	0.00	00:00:00	7.21	0.00	00:00:00	3.40	0.00	00:00:00	24:00:00	241.86
06/04/2019	10.45	6.72	0.00	01:54:30	15.33	00:00:00	24.64	0.00	00:00:00	7.76	0.00	00:00:00	1.67	0.00	00:00:00	24:00:00	251.27
07/04/2019	9.95	7.15	0.00	00:33:00	3.37	00:00:00	25.05	0.00	00:00:00	6.65	0.00	00:00:00	0.81	0.00	00:00:00	24:00:00	238.93
08/04/2019	11.40	7.08	0.00	00:18:00	2.24	00:00:00	24.97	0.00	00:00:00	7.61	0.00	00:00:00	8.03	16.18	01:36:30	24:00:00	273.62
09/04/2019	9.99	6.81	0.00	01:53:20	14.90	00:00:00	24.89	0.00	00:00:00	10.21	0.00	00:00:00	1.99	1.54	00:10:20	24:00:00	239.81
10/04/2019	11.49	7.05	0.00	00:00:00	0.00	00:00:00	25.06	0.00	00:00:00	7.13	0.00	00:00:00	3.13	0.00	00:00:00	24:00:00	275.83
11/04/2019	9.74	7.00	0.00	00:13:30	1.46	00:00:00	24.15	0.00	00:00:00	9.32	0.00	00:00:00	3.96	0.00	00:00:00	23:54:00	232.77
12/04/2019	12.23	7.37	0.00	00:17:40	1.67	00:00:00	24.06	0.00	00:00:00	8.93	0.00	00:00:00	3.96	0.00	00:00:00	24:00:00	293.51
13/04/2019	9.02	7.56	0.00	00:00:00	0.00	00:01:30	23.86	0.00	00:00:00	5.09	0.00	00:00:00	8.37	0.00	00:00:00	23:54:00	215.22
14/04/2019	11.85	7.67	0.00	00:00:00	0.00	00:13:40	22.89	0.00	00:00:00	6.16	0.00	00:00:00	11.40	14.75	00:51:50	23:48:30	281.66
15/04/2019	10.06	7.77	0.00	00:00:00	0.00	01:41:40	20.44	0.00	00:00:00	8.03	0.00	00:00:00	15.88	39.75	02:39:10	24:00:00	241.54
16/04/2019	9.22	7.67	0.00	00:00:30	0.02	00:23:40	20.97	0.00	00:00:00	7.95	0.00	00:00:00	12.46	0.00	00:00:00	24:00:00	221.42
17/04/2019	12.80	7.75	0.00	00:00:00	0.00	00:02:00	21.82	0.00	00:00:00	8.97	0.00	00:00:00	18.66	3.54	00:26:00	24:00:00	307.35
18/04/2019	13.58	7.63	0.00	00:06:50	1.28	00:00:00	21.58	0.00	00:00:00	8.77	0.00	00:00:00	17.02	0.00	00:00:00	24:00:00	325.67
19/04/2019	13.92	7.24	0.00	00:00:00	0.00	00:00:00	21.87	0.00	00:00:00	11.69	0.00	00:00:00	18.14	7.99	00:25:40	24:00:00	334.56
20/04/2019	11.04	7.07	0.00	00:00:00	0.00	00:00:00	22.53	0.00	00:00:00	26.69	0.00	00:00:00	12.04	0.00	00:00:00	24:00:00	265.16
21/04/2019	12.96	6.63	1.74	00:30:50	6.48	00:00:00	22.36	0.00	00:00:00	52.44	1.74	00:04:10	9.29	0.00	00:00:00	24:00:00	311.39
22/04/2019	13.64	6.20	0.00	01:32:30	15.99	00:00:00	22.41	0.00	00:00:00	30.68	0.00	00:00:00	7.16	0.00	00:00:00	24:00:00	327.69
23/04/2019	14.24	5.84	0.00	03:45:10	51.47	00:00:00	23.25	0.00	00:00:00	48.64	0.00	00:00:00	3.25	0.00	00:00:00	24:00:00	341.36
24/04/2019	13.22	5.92	0.00	00:40:10	9.00	00:00:00	22.84	0.00	00:00:00	70.22	0.00	00:00:00	2.90	0.00	00:00:00	24:00:00	317.45
25/04/2019	14.48	6.32	7.86	00:00:00	0.00	00:00:00	21.72	0.00	00:00:00	90.00	7.86	00:33:10	3.42	0.00	00:00:00	23:56:00	346.44
26/04/2019	11.64	7.18	0.00	00:00:00	0.00	00:35:40	23.01	0.00	00:00:00	23.40	0.00	00:00:00	2.65	0.00	00:00:00	24:00:00	279.21
27/04/2019	11.37	7.81	0.00	00:00:00	0.00	00:01:00	23.45	0.00	00:00:00	78.21	0.00	00:00:00	0.70	0.00	00:00:00	24:00:00	272.91
28/04/2019	9.51	7.29	0.00	00:25:50	5.91	00:02:40	23.14	0.00	00:00:00	121.58	0.00	00:00:00	0.01	0.00	00:00:00	24:00:00	228.53
29/04/2019	8.85	7.36	0.00	00:03:40	0.51	00:00:00	23.44	0.00	00:00:00	53.72	0.00	00:00:00	5.65	11.22	01:26:20	24:00:00	212.25
30/04/2019	9.65	7.89	0.00	00:00:00	0.00	02:18:10	22.83	0.00	00:00:00	7.16	0.00	00:00:00	3.10	8.78	00:55:40	23:49:00	229.57
Max.	14.48	7.89	7.86		54.34		25.49		0.00	131.58	7.86		18.66	39.75		346.44	
Min.	8.85	5.84	0.00		0.00		20.44		0.00	5.09	0.00		0.01	0.00		212.25	
Dep. Seuil Jour																	
Nb Jour Inva.																	
Dep. Seuil Max	06:17						00:00										
Dep. Seuil Min	21:08																
Moy/Tot.	11.25	7.03	9.86	21:14:20	204.85	06:23:20	23.27	0.00	00:00:00	26.01	9.86	00:39:20	6.44	103.75	06:31:30	259 23:14:30	8089.11



Rapport Rejet AQ Mensuel

Rapport Mensuel												Mai 2019		
Rejet Injuncte														
Unité	Ph	Volume Ph Inf/Dep	Temp Ph Inf/Dep	Volume Ph Sup/Dep	Temp Ph Sup/Dep	Temperature	Volume Temperature	Temp Temperature	Turbidité	Volume Turbidité Temp Turbidité	Temp COT	Volume COT	Marche/Rejet	Volume Rejet
Dep. Seuil Min		m3	hh:mm:ss	m3	hh:mm:ss	degreC	m3	hh:mm:ss	mg/l	hh:mm:ss	hh:mm:ss	m3	hh:mm:ss	m3
01/05/2019	9.35	7.97	2.81	0.00	00:00:00	23.13	30	00:00:00	29.67	00:25:40	0.00	0.01	00:00:00	224.27
02/05/2019	7.89	7.16	0.00	00:00:00	00:00:00	25.64		00:01:50	12.69	00:00:00	11.86	5.90	00:52:40	189.33
03/05/2019	9.72	6.92	0.00	00:00:00	00:00:00	23.52		00:00:00	25.33	00:00:00	4.13	4.32	00:24:50	233.37
04/05/2019	8.29	6.89	0.00	00:00:00	00:00:00	23.45		00:00:00	26.30	00:00:00	4.21	4.74	00:25:10	199.10
05/05/2019	9.24	6.97	0.00	00:00:00	00:00:00	22.98		00:00:00	28.88	00:00:00	15.38	9.08	00:49:40	221.50
06/05/2019	8.72	6.68	0.00	01:16:50	00:00:00	23.33		00:00:00	21.34	00:00:00	8.40	8.40	00:00:00	209.53
07/05/2019	10.20	6.64	0.00	00:00:00	00:00:00	21.78		00:00:00	21.06	00:00:00	12.59	12.59	01:14:20	244.86
08/05/2019	14.66	6.80	0.00	00:00:00	00:00:00	21.91		00:00:00	26.98	00:00:00	13.76	7.09	00:23:50	352.44
09/05/2019	12.39	6.85	0.00	00:00:00	00:00:00	23.08		00:00:00	37.04	00:00:00	6.85	6.89	00:35:20	297.98
10/05/2019	13.09	6.90	0.00	00:00:00	00:00:00	23.78		00:00:00	31.76	00:00:00	5.90	5.90	00:25:40	314.69
11/05/2019	14.87	6.97	0.00	00:00:00	00:00:00	23.30		00:00:00	35.74	00:00:00	70.04	70.04	05:11:30	356.86
12/05/2019	14.63	6.35	0.00	00:00:00	00:00:00	24.22		00:00:00	89.58	00:00:00	14.80	14.80	03:02:20	351.64
13/05/2019	14.10	6.49	0.19	00:00:00	00:37:20	24.09		00:00:00	95.37	00:01:10	13.75	30.19	02:35:20	338.64
14/05/2019	14.32	6.90	0.00	00:33:50	00:00:00	23.23		00:00:00	6.28	00:00:00	11.08	21.12	01:14:00	343.79
15/05/2019	16.00	6.84	0.00	00:11:20	00:00:00	22.75		00:00:00	4.56	00:00:30	5.15	6.29	00:23:40	384.18
16/05/2019	13.05	6.51	0.12	02:32:10	00:00:00	23.86		00:00:00	4.37	00:00:00	5.48	6.17	00:24:50	313.17
17/05/2019	10.78	7.05	0.00	00:00:00	00:00:00	24.82		00:00:00	1.74	00:00:00	2.39	0.00	00:00:00	257.62
18/05/2019	9.90	6.94	0.00	00:00:00	00:00:00	25.55		00:00:00	4.96	00:00:00	2.39	0.00	00:00:00	238.29
19/05/2019	10.38	6.85	0.00	00:00:00	00:00:00	25.33		00:00:00	11.93	00:00:00	4.56	4.56	00:25:20	249.57
20/05/2019	8.68	6.61	0.00	00:00:00	00:00:00	24.19		00:00:00	31.06	00:00:00	15.32	0.00	00:00:00	209.02
21/05/2019	10.45	6.87	8.74	00:00:00	00:00:00	22.99		00:00:00	89.56	00:39:00	11.09	0.00	00:00:00	250.86
22/05/2019	10.13	7.10	19.46	00:00:00	00:00:00	24.22		00:00:00	180.02	03:28:10	23.13	9.86	02:34:50	243.62
23/05/2019	8.99	7.17	0.00	00:00:00	00:00:00	25.24		00:00:00	5.85	00:00:00	6.80	0.00	00:00:00	204.86
24/05/2019	8.54	7.22	0.00	00:00:00	00:00:00	25.38		00:00:00	5.56	00:00:00	2.79	0.00	00:00:00	204.86
25/05/2019	8.62	7.16	0.00	00:00:00	00:00:00	25.76		00:00:00	4.11	00:00:00	4.20	0.00	00:00:00	216.02
26/05/2019	6.87	7.34	0.00	00:00:00	00:00:00	25.12		00:00:00	4.40	00:00:00	1.93	0.00	00:00:00	165.50
27/05/2019	12.20	6.99	0.00	00:00:00	00:00:00	23.68		00:00:00	9.51	00:00:00	7.40	8.24	00:49:00	292.33
28/05/2019	12.17	7.10	0.00	00:00:00	00:00:00	24.12		00:00:00	8.76	00:00:00	2.21	0.00	00:00:00	291.79
29/05/2019	8.40	7.11	0.00	00:00:00	00:00:00	23.41		00:00:00	10.30	00:00:00	2.80	0.00	00:00:00	202.06
30/05/2019	7.13	7.36	0.00	00:00:00	00:00:00	24.23		00:00:00	13.65	00:00:00	8.94	8.07	00:22:50	168.87
31/05/2019	10.92	7.34	0.00	00:00:00	00:00:00	25.18		00:00:00	24.80	00:00:00	2.54	0.00	00:00:00	261.92
Max.	16.00	7.97	19.46	30.61	00:00:00	25.76	0.33	00:00:00	180.02	19.46	29.98	73.15	24.00:00	384.18
Min.	6.87	6.35	0.00	0.00	00:00:00	21.78	0.00	00:01:50	1.74	0.00	0.01	0.00	00:00:00	165.50
Dep. Seuil Jour														
Nb Jour Inva.	0	0	0	0	0	0	0	0	0	0	0	0	0	0
Dep. Seuil Max	10.80	01.366				00.02								
Dep. Seuil Min		04.533												
Moy./Tnl.		6.97	31.32	04:34:10	51.33	23.98	0.33	00:01:50	29.15	31.32	04:34:30	7.96	299.97	22:15:10 305:23:7.00
														803.455



Rapport Rejet AQ Mensuel

Rapport Mensuel												juin 2019								
Rejet liquide																				
Date	Unité	Débit	Ph	Volumé Ph Inf/Dep	Temp Ph Inf/Dep	Volumé Ph Sup/Dep	Temp Ph Sup/Dep	Température	Volumé Température	Température	Turbidité	Volumé Turbide Temp	Temp Turbide Temp	COT	Volumé COT	Temp COT	Marchés/Rejets	Volumé Rejet		
																			m3	hh:mm:ss
01/06/2019	8.68	7.44	0.00	00:00:00	0.00	00:00:00	0.00	64.71	28.77	04:13:50	29.90	0.00	00:00:00	0.00	3.48	00:00:00	24:00:00	208.67		
02/06/2019	9.36	8.13	0.00	00:22:10	3.74	06:53:20	1.51	26.96	29.33	09:20:40	26.42	0.00	00:00:00	0.00	3.38	00:00:00	24:00:00	225.05		
03/06/2019	5.73	7.53	0.00	00:00:00	0.00	00:00:00	31.41	29.33	09:20:40	32.31	0.00	0.00	00:00:00	0.00	9.15	00:00:00	24:00:00	138.54		
04/06/2019	Invalide	Invalide	0.00	00:00:00	0.00	00:00:00	0.00	Invalide	Invalide	00:00:00	Invalide	0.00	00:00:00	0.00	Invalide	00:00:00	19:54:00	163.76		
05/06/2019	8.34	6.72	0.00	00:00:00	0.00	00:00:00	24.54	24.54	00:00:00	00:00:00	57.69	0.00	00:00:00	0.00	9.13	00:00:00	24:00:00	199.56		
06/06/2019	11.06	7.22	2.12	00:00:00	0.00	00:00:00	0.00	21.57	21.34	00:00:00	36.06	2.12	00:05:20	0.00	7.06	00:00:00	24:00:00	264.88		
07/06/2019	4.55	7.16	0.00	00:00:00	0.00	00:00:00	0.00	23.82	23.82	00:00:00	7.51	0.00	00:00:00	0.00	8.45	00:00:00	22:51:00	106.78		
08/06/2019	6.06	7.00	0.00	00:00:00	0.00	00:00:00	0.00	52.44	24.74	04:18:20	11.42	0.00	00:00:00	0.00	9.81	00:00:00	23:57:20	145.24		
09/06/2019	4.35	6.83	0.00	00:00:00	0.00	00:00:00	0.00	2.03	24.52	00:16:00	21.29	0.00	00:00:00	0.00	4.69	00:00:00	22:57:00	102.44		
10/06/2019	6.70	8.63	0.00	00:00:00	0.00	00:00:00	0.00	22.46	22.46	00:00:00	45.98	2.51	00:26:30	0.00	9.75	00:00:00	23:04:50	160.73		
11/06/2019	7.28	7.42	2.51	00:00:00	0.00	00:00:00	0.00	23.39	23.39	00:00:00	21.76	0.00	00:00:00	0.00	13.24	00:00:00	24:00:00	175.31		
12/06/2019	7.82	6.87	0.00	00:00:00	0.00	00:00:00	0.00	25.83	25.83	00:00:00	8.78	0.00	00:00:00	0.00	16.85	03:20:40	24:00:00	187.76		
13/06/2019	9.31	6.87	0.00	00:00:00	0.00	00:00:00	0.00	25.34	25.34	00:00:00	24.49	0.00	00:00:00	0.00	8.27	00:00:00	24:00:00	223.67		
14/06/2019	8.43	6.58	0.00	00:00:00	0.00	00:00:00	0.00	25.80	25.80	00:00:00	43.73	0.00	00:00:00	0.00	12.88	00:00:00	24:00:00	201.82		
15/06/2019	10.02	6.60	0.00	00:00:00	0.00	00:00:00	0.00	25.17	25.17	00:00:00	51.53	0.00	00:00:00	0.00	4.07	00:00:00	24:00:00	241.08		
16/06/2019	7.16	6.55	0.00	00:00:00	0.00	00:00:00	0.00	25.34	25.34	00:00:00	25.11	0.17	00:01:00	0.00	6.48	00:00:00	24:00:00	172.05		
17/06/2019	8.92	6.58	0.17	00:00:00	0.00	00:00:00	0.00	25.81	25.81	00:00:00	19.52	0.00	00:00:00	0.00	6.57	00:00:00	24:00:00	214.17		
18/06/2019	10.09	6.44	0.00	00:00:00	0.00	00:00:00	0.00	25.67	25.67	00:00:00	22.19	0.18	00:01:00	0.00	7.45	00:25:40	24:00:00	241.82		
19/06/2019	9.16	6.64	0.18	00:00:00	0.00	00:00:00	0.00	27.00	27.00	01:33:00	10.93	0.00	00:00:00	0.00	11.59	00:51:50	24:00:00	219.92		
20/06/2019	12.59	6.71	0.00	00:00:00	0.00	00:00:00	0.00	24.91	24.91	00:00:00	24.04	0.00	00:00:00	0.00	3.38	00:26:00	24:00:00	302.43		
21/06/2019	6.72	6.70	0.00	00:00:00	0.00	00:00:00	0.00	28.96	28.96	09:19:00	18.10	0.00	00:00:00	0.00	3.01	00:00:00	24:00:00	161.44		
22/06/2019	15.75	7.46	0.00	00:00:00	0.00	00:00:00	0.00	187.07	187.07	00:02:40	19.42	0.00	00:00:00	0.00	11.00	00:45:30	24:00:00	378.17		
23/06/2019	12.41	7.17	0.00	00:00:00	0.00	00:00:00	0.00	80.98	80.98	07:43:00	23.18	0.00	00:00:00	0.00	10.71	00:25:50	24:00:00	298.14		
24/06/2019	13.71	7.18	0.00	00:00:00	0.00	00:00:00	0.00	29.64	29.64	00:00:00	23.18	0.00	00:00:00	0.00	5.30	00:45:30	24:00:00	329.26		
25/06/2019	9.17	7.13	23.21	00:00:00	0.00	00:00:00	0.00	26.54	26.54	00:58:50	187.43	23.21	03:36:10	0.00	12.75	00:48:20	24:00:00	270.40		
26/06/2019	11.43	7.31	0.00	00:00:00	0.00	00:00:00	0.00	29.12	29.12	03:44:30	9.28	0.00	00:00:00	0.00	6.54	00:00:00	24:00:00	224.46		
27/06/2019	10.54	6.97	0.00	00:00:00	0.00	00:00:00	0.00	30.45	30.45	03:35:30	15.13	0.00	00:00:00	0.00	7.76	00:49:40	24:00:00	252.94		
28/06/2019	9.96	7.16	0.00	00:00:00	0.00	00:00:00	0.00	165.57	165.57	17:22:50	12.29	0.00	00:00:00	0.00	4.03	00:00:00	24:00:00	238.82		
29/06/2019	8.29	6.95	0.00	01:07:30	11.03	00:10:20	0.00	31.27	31.27	21:28:00	10.69	0.00	00:00:00	0.00	3.96	00:21:20	24:00:00	199.44		
30/06/2019	7.47	7.14	0.00	00:00:00	0.00	00:00:00	0.00	148.09	148.09	20:49:00	12.61	0.00	00:00:00	0.00	2.50	00:00:00	23:44:40	177.67		
Max.	15.75	8.63	23.21	00:00:00	11.03	00:00:00	0.00	31.27	31.27	187.07	187.43	23.21	03:36:10	0.00	16.85	00:26:00	24:00:00	378.17		
Min.	4.35	6.44	0.00	00:22:10	0.00	00:00:00	0.00	21.34	21.34	0.00	7.51	0.00	00:00:00	0.00	2.50	00:00:00	24:00:00	102.44		
Dep. Seuil Jour	1	1	0	0	0	0	0	1	1	0	1	0	0	0	1	0	0	0		
Nb Jour Inva.								4	4	08:55										
Dep. Seuil Max	17.42																			
Dep. Seuil Min	01:31																			
Moy./Tot.	8.98	7.07	23.19	01:29:46	14.77	17:41:46	0.00	987.94	987.94	4	09:05:10	29.56	04:10:00	0.00	8.00	107.32	13:18:00	29	16:28:50	6426.42

* Le 04/06/2019, coupure électrique EDF lors de l'arrêt technique lignes EME
 * Le 10/06/2019, dépassement pH, cf fiche incident 19-003.
 * Les 28-29-30/06/2019, dépassement température, cf fiches incident 19-005, 19-006, 19-007



Rapport Rejet AQ Mensuel

Rapport Mensuel															Juillet 2019	
Rejet Inquiné																
Dép.	Unité	Débit	Ph	Volume Ph		Temp Ph		Température		Turbidité	Volume Turbidité		Temp COF		Marche/Rejets	Volume Rejet
				Inf/Dep.	Sup/Dep.	Inf/Dep.	Sup/Dep.	degreC	m3		mg/l	m3	Dep.	hh:mm:ss		
Dep.	Seuil Max	Seuil Jour	Seuil Min	m3	m3	hh:mm:ss	hh:mm:ss	m3	degreC	mg/l	m3	mg/l	m3	hh:mm:ss	hh:mm:ss	m3
01/07/2019	7.01	0.00	00:16:30	1.93	00:00:00	46.80	08:10:40	17.82	00:00:00	5.06	00:00:00	0.00	00:00:00	23:44:30	166.88	
02/07/2019	12.25	0.00	00:56:40	10.84	00:00:00	25.36	00:09:50	19.30	00:00:00	7.28	00:00:00	2.86	00:23:10	23:54:00	292.39	
03/07/2019	7.16	1.29	00:00:30	0.10	00:00:00	26.88	00:01:40	40.22	00:06:30	3.27	00:00:00	0.00	00:00:00	23:53:00	272.87	
04/07/2019	11.16	1.95	00:00:40	0.20	00:00:00	26.95	01:19:20	66.82	00:05:40	4.51	00:00:00	6.76	00:25:10	23:52:00	266.27	
05/07/2019	10.65	7.30	00:00:00	0.00	00:42:20	26.81	00:17:00	44.26	00:00:00	2.74	00:00:00	0.00	00:00:00	23:49:50	253.25	
06/07/2019	11.25	0.00	00:00:00	0.00	00:15:10	26.63	01:48:30	53.62	00:00:00	5.28	00:00:00	6.89	00:25:00	24:00:00	270.42	
07/07/2019	8.68	7.23	00:00:00	0.00	00:00:00	26.00	03:33:00	35.02	00:00:00	4.36	00:00:00	0.00	00:00:00	24:00:00	208.52	
08/07/2019	9.99	7.22	00:00:00	0.00	00:00:00	26.36	00:05:20	23.89	00:00:00	2.70	00:00:00	0.00	00:00:00	24:00:00	240.17	
09/07/2019	10.28	7.23	00:00:00	0.00	00:00:00	25.30	00:00:00	36.07	00:00:00	6.24	00:00:00	13.14	00:51:00	24:00:00	246.51	
10/07/2019	10.37	7.23	00:00:00	0.00	00:00:00	24.01	00:00:00	36.99	00:00:00	10.74	00:00:00	3.97	00:49:20	24:00:00	248.96	
11/07/2019	11.38	7.27	00:00:00	0.00	00:32:00	26.00	00:00:00	33.70	00:00:00	7.88	00:00:00	8.85	00:48:50	24:00:00	273.17	
12/07/2019	14.13	7.05	00:00:00	0.00	00:00:00	25.72	00:00:00	30.15	00:00:00	3.97	00:00:00	0.00	00:00:00	23:53:00	337.51	
13/07/2019	11.21	6.90	00:00:00	0.00	00:00:00	25.26	00:00:00	34.64	00:00:00	1.97	00:00:00	0.00	00:00:00	24:00:00	268.78	
14/07/2019	12.83	7.12	00:00:00	0.00	00:00:00	25.98	00:00:00	38.44	00:00:00	3.82	00:00:00	6.25	00:25:30	24:00:00	307.92	
15/07/2019	11.78	7.03	00:00:00	0.00	00:00:00	25.35	00:00:00	51.08	00:00:00	3.44	00:00:00	0.00	00:00:00	24:00:00	283.05	
16/07/2019	14.24	6.93	00:00:00	0.00	00:00:00	25.60	00:00:00	237.15	04:14:30	2.66	00:00:00	0.00	00:00:00	24:00:00	341.94	
17/07/2019	13.71	7.42	00:02:00	0.52	00:00:00	26.96	00:08:40	60.36	00:59:10	0.36	00:00:00	0.00	00:00:00	24:00:00	328.97	
18/07/2019	16.13	7.31	00:00:00	0.00	00:04:40	27.62	00:00:00	13.73	00:00:00	3.52	00:00:00	8.25	00:37:20	24:00:00	387.08	
19/07/2019	15.39	7.47	00:00:00	0.00	00:00:00	28.76	00:13:20	12.86	00:00:00	2.46	00:00:00	0.00	00:00:00	24:00:00	369.53	
20/07/2019	11.45	7.27	00:00:00	0.00	00:00:00	27.91	00:28:10	21.39	00:00:00	10.82	00:00:00	23.89	02:30:50	24:00:00	275.08	
21/07/2019	8.33	7.08	00:00:00	0.00	00:00:00	27.54	00:00:00	16.44	00:00:00	2.92	00:00:00	0.05	00:00:20	24:00:00	199.61	
22/07/2019	10.93	6.78	00:00:00	0.00	00:00:00	27.94	03:06:50	20.39	00:00:00	2.92	00:00:00	0.00	00:00:00	24:00:00	263.34	
23/07/2019	13.11	6.97	00:00:00	0.00	00:00:00	28.81	04:27:00	20.89	00:00:00	6.61	00:00:00	7.08	00:23:00	24:00:00	315.07	
24/07/2019	11.50	7.30	00:00:00	0.00	00:00:00	29.84	16:50:10	43.65	00:00:00	14.09	00:00:00	0.00	00:00:00	23:54:00	274.94	
25/07/2019	14.90	7.23	00:00:00	0.00	00:00:00	27.82	01:33:00	46.66	00:17:10	19.44	00:00:00	20.61	01:27:30	24:00:00	355.97	
26/07/2019	13.04	7.26	00:00:00	0.00	00:00:00	29.89	14:37:50	29.07	00:00:30	6.74	00:00:00	1.72	00:08:10	23:53:00	311.50	
27/07/2019	11.61	6.87	00:00:00	0.00	00:00:00	30.81	23:10:20	19.29	00:00:00	6.39	00:00:00	0.00	00:00:00	24:00:00	278.94	
28/07/2019	8.38	6.61	00:00:00	0.00	00:00:00	29.54	02:59:20	21.90	00:00:00	4.40	00:00:00	4.82	00:23:30	24:00:00	201.66	
29/07/2019	10.80	6.75	00:00:00	0.00	00:00:00	28.32	00:00:00	24.63	00:00:00	4.36	00:00:00	0.00	00:00:00	24:00:00	259.52	
30/07/2019	13.28	7.17	00:00:00	0.00	00:26:00	27.93	00:00:00	31.03	00:00:00	27.12	00:00:00	97.04	06:57:50	24:00:00	318.78	
31/07/2019	10.65	6.62	00:00:00	0.00	00:00:00	28.42	00:00:00	33.50	00:00:00	2.98	00:00:00	0.00	00:00:00	24:00:00	255.68	
Max.	16.13	7.47	71.25	10.84	00:00:00	30.81	276.43	237.15	71.25	27.12	97.04	97.04	00:00:00	24:00:00	387.08	
Min.	7.01	6.61	0.00	0.00	00:00:00	24.01	0.00	12.86	0.00	0.36	0.00	0.00	00:00:00	24:00:00	166.88	
Dep. Seuil Jour																
Nb Jour Inva.																
Dep. Seuil Max	02:40															
Dep. Seuil Min	01:16															
Moy./Jou.	11.67	7.11	91.99	13.59	02:06:10	27.24	989.82	39.20	91.99	6.16	212.18	166.36	166.36	22:40:50	8674.28	



Rapport Rejet AQ Mensuel

Rapport Mensuel														Septembre 2019				
Rejet Liquide																		
Unité	Scail Jour	Scail Max	Scail Min	Ph	Volume Ph Inf/Dep	Temp Ph Inf/Dep	Volume Ph Sup/Dep	Temp Ph Sup/Dep	Temperature	Volume Temperature	Temp Temperature	Turbidité	Volume Turbid	Temp Turbid	Volume CO2	Temp CO2	Marche/Rejet	Volume Rejet
m3/h					m3	hh:mm:ss	m3	hh:mm:ss	degreC	m3	hh:mm:ss	mg/l	m3	hh:mm:ss	m3	hh:mm:ss	hh:mm:ss	m3
Dep. Scail Min	8.5	5.5							30			600			40			
01/09/2019	8.62	6.45	0.00	0.00	02:42:50	17:48	00:00:00	0.00	00:00:00	27.65	0.00	00:00:00	25.82	0.00	3.00	00:00:00	24:00:00	206.68
02/09/2019	9.66	6.22	0.00	0.00	01:16:20	12.63	00:00:00	0.00	00:00:00	26.66	0.00	00:00:00	29.56	0.00	2.57	00:00:00	24:00:00	231.62
03/09/2019	11.49	6.49	0.00	0.00	00:10:50	2.57	00:00:00	0.00	00:00:00	24.88	0.00	00:00:00	49.97	0.00	7.49	00:51:10	24:00:00	276.20
04/09/2019	11.91	6.50	0.00	0.00	00:00:00	0.00	00:00:00	0.00	00:00:00	25.05	0.00	00:00:00	70.30	0.00	4.48	00:25:10	23:48:10	283.24
05/09/2019	12.26	6.41	0.00	0.00	00:03:10	0.91	00:00:00	0.00	00:00:00	24.34	0.00	00:00:00	85.91	0.00	7.47	00:51:00	24:00:00	294.56
06/09/2019	10.33	6.44	0.00	0.00	00:00:00	0.00	00:00:00	0.00	00:00:00	24.81	0.00	00:00:00	79.46	0.00	7.48	01:40:50	24:00:00	248.15
07/09/2019	11.27	6.39	0.00	0.00	00:00:00	0.00	00:00:00	0.00	00:00:00	24.49	0.00	00:00:00	79.96	0.00	8.35	01:40:00	24:00:00	270.41
08/09/2019	8.03	6.50	0.00	0.00	00:00:00	0.00	00:00:00	0.00	00:00:00	25.94	0.00	00:00:00	97.03	0.00	1.65	00:00:00	24:00:00	193.08
09/09/2019	11.59	6.28	0.00	0.00	01:00:30	13.22	00:00:00	0.00	00:00:00	23.57	0.00	00:00:00	120.66	0.00	10.62	00:52:10	24:00:00	278.11
10/09/2019	14.18	6.99	0.00	0.00	00:06:50	1.15	00:00:00	0.00	00:00:00	23.74	0.00	00:00:00	157.61	0.00	10.02	00:00:00	24:00:00	340.48
11/09/2019	11.25	6.73	0.00	0.00	00:00:00	0.00	00:00:00	0.00	00:00:00	25.49	0.00	00:00:00	177.45	0.00	2.71	00:00:00	24:00:00	270.50
12/09/2019	12.95	6.50	0.00	0.00	00:00:00	0.00	00:00:00	0.00	00:00:00	26.06	0.00	00:00:00	181.73	0.00	3.15	00:00:00	24:00:00	310.68
13/09/2019	12.40	6.35	0.00	0.00	00:00:00	0.00	00:00:00	0.00	00:00:00	25.88	0.00	00:00:00	94.21	0.00	14.45	00:26:10	24:00:00	297.35
14/09/2019	11.42	6.41	0.00	0.00	00:00:00	0.00	00:00:00	0.00	00:00:00	26.69	0.00	00:00:00	10.32	0.00	2.25	03:59:10	24:00:00	273.49
15/09/2019	10.27	6.61	0.00	0.00	00:00:00	0.00	00:00:00	0.00	00:00:00	27.38	0.00	00:00:00	17.45	0.00	3.54	00:25:20	24:00:00	246.38
16/09/2019	11.43	7.63	0.00	0.00	00:00:00	0.00	00:00:00	0.00	00:00:00	26.79	0.00	00:00:00	26.47	0.00	2.80	00:00:00	23:49:30	272.57
17/09/2019	12.51	7.38	0.00	0.00	00:00:00	0.00	00:00:00	0.00	00:00:00	26.98	0.00	00:00:00	38.69	0.00	4.04	00:25:30	23:31:00	294.06
18/09/2019	11.93	6.70	0.00	0.00	00:00:00	0.00	00:00:00	0.00	00:00:00	25.64	0.00	00:00:00	62.70	0.00	6.82	00:00:00	24:00:00	286.35
19/09/2019	13.65	6.49	0.00	0.00	00:00:00	0.00	00:00:00	0.00	00:00:00	24.94	0.00	00:00:00	92.67	0.00	4.64	00:00:00	24:00:00	327.82
20/09/2019	12.94	6.44	0.00	0.00	00:00:00	0.00	00:00:00	0.00	00:00:00	25.30	0.00	00:00:00	131.29	0.00	6.54	00:50:40	24:00:00	310.97
21/09/2019	11.82	6.49	0.00	0.00	00:00:00	0.00	00:00:00	0.00	00:00:00	25.97	0.00	00:00:00	138.88	0.00	1.43	00:00:00	24:00:00	288.25
22/09/2019	12.01	6.35	0.00	0.00	00:00:00	0.00	00:00:00	0.00	00:00:00	27.02	0.00	00:00:00	142.16	0.00	1.85	00:00:00	24:00:00	307.35
23/09/2019	12.80	6.51	0.00	0.00	00:00:10	0.03	00:00:00	0.00	00:00:00	26.03	0.00	00:00:00	62.82	0.00	10.83	00:26:50	24:00:00	288.25
24/09/2019	14.36	6.57	0.00	0.00	00:00:00	0.00	00:00:00	0.00	00:00:00	25.09	0.00	00:00:00	18.26	0.00	5.78	00:00:00	24:00:00	307.35
25/09/2019	12.55	6.26	0.00	0.00	00:00:00	0.00	00:00:00	0.00	00:00:00	25.15	0.00	00:00:00	27.17	0.00	3.79	00:00:00	24:00:00	344.69
26/09/2019	12.57	6.15	0.00	0.00	00:00:00	0.00	00:00:00	0.00	00:00:00	26.47	0.00	00:00:00	30.68	0.00	2.00	00:00:00	23:52:00	299.23
27/09/2019	12.35	6.42	0.00	0.00	00:00:00	0.00	00:05:00	0.00	00:00:00	25.98	0.00	00:00:00	22.26	0.00	4.28	00:00:00	23:56:00	301.02
28/09/2019	12.42	6.54	0.00	0.00	00:00:00	0.00	00:00:00	0.00	00:00:00	26.17	0.00	00:00:00	6.37	0.00	2.46	00:00:00	23:56:00	295.26
29/09/2019	11.67	6.51	0.00	0.00	00:00:00	0.00	00:00:00	0.00	00:00:00	25.83	0.00	00:00:00	8.98	0.00	3.37	00:00:00	24:00:00	298.42
30/09/2019	11.82	6.29	0.00	0.00	00:00:00	0.00	00:00:00	0.00	00:00:00	25.19	0.00	00:00:00	32.45	0.00	6.40	00:00:00	24:00:00	280.30
30/09/2019	14.36	7.63	0.00	0.00	00:00:00	17.48	00:00:00	0.00	00:00:00	27.65	0.00	00:00:00	181.73	0.00	14.45	00:00:00	24:00:00	344.69
Max.	8.03	6.15	0.00	0.00	00:00:00	0.00	00:00:00	0.00	00:00:00	23.57	0.00	00:00:00	6.37	0.00	1.43	00:00:00	24:00:00	193.08
Min.	0.00	0.00	0.00	0.00	00:00:00	0.00	00:00:00	0.00	00:00:00	0.00	0.00	00:00:00	0.00	0.00	0.00	00:00:00	24:00:00	0.00
Dep. Scail Jour	0.00	0.00	0.00	0.00	00:00:00	0.00	00:00:00	0.00	00:00:00	0.00	0.00	00:00:00	0.00	0.00	0.00	00:00:00	24:00:00	0.00
Nb Jour Java.	0	0	0	0	0	0	0	0	0	0	0	0	0	0	0	0	0	0
Dep. Scail Max	00:05	00:05	00:05	00:05	00:00:00	00:00:00	00:00:00	00:00:00	00:00:00	00:00:00	00:00:00	00:00:00	00:00:00	00:00:00	00:00:00	00:00:00	00:00:00	00:00:00
Dep. Scail Min	05:21	05:21	05:21	05:21	00:00:00	00:00:00	00:00:00	00:00:00	00:00:00	00:00:00	00:00:00	00:00:00	00:00:00	00:00:00	00:00:00	00:00:00	00:00:00	00:00:00
May/Total	11.81	6.53	0.00	0.00	05:20:40	47.99	00:05:00	0.00	00:00:00	25.71	0.00	00:00:00	70.69	0.00	5.21	12:54:00	29:22:52:40	8495.26



Rapport Rejet AQ Mensuel

Rapport Mensuel														Octobre 2019	
Rejet Liquide															
Unité m3/h	Debit	Ph	Volume Ph Inf/Dep	Temp Ph Inf/Dep	Volume Ph Sup/Dep	Temp Ph Sup/Dep	Temperature	Volume Temperature	Temp Temperature	Turbidité	Volume Turbid/Temp Turbidité COOT	Temp COOT	Volume COOT	Marche/Rejets	Volume Rejet
Seuil Max			m3	hh:mm:ss	m3	hh:mm:ss	degreC	m3	hh:mm:ss	mg/l	m3	hh:mm:ss	m3	hh:mm:ss	m3
Seuil Min								30			40				
01/10/2019	12.38		6.17	0.00	00:00:00	00:00:00	25.92	0.00	00:00:00	44.66	0.00	00:00:00	4.76	00:00:00	297.28
02/10/2019	12.91		6.27	0.00	00:00:00	00:00:00	25.71	0.00	00:00:00	61.78	0.00	00:00:00	3.93	00:00:00	310.43
03/10/2019	14.25		6.34	0.00	00:00:00	00:00:00	23.74	0.00	00:00:00	48.58	0.00	00:00:00	6.65	00:00:00	342.20
04/10/2019	12.21		6.75	0.00	00:00:00	00:00:00	24.47	0.00	00:00:00	34.57	0.00	00:00:00	2.84	00:00:00	292.71
05/10/2019	11.90		6.90	0.00	00:00:00	00:00:00	25.17	0.00	00:00:00	52.00	0.00	00:00:00	1.86	00:00:00	285.67
06/10/2019	11.61		7.02	0.00	00:00:00	00:00:00	25.31	0.00	00:00:00	72.52	0.00	00:00:00	11.14	01:17:10	279.58
07/10/2019	11.48		6.70	0.00	00:00:00	00:00:00	24.38	0.00	00:00:00	35.23	0.00	00:00:00	12.19	01:12:40	275.43
08/10/2019	13.18		6.64	0.00	00:00:00	00:00:00	24.53	0.00	00:00:00	19.56	0.00	00:00:00	5.84	00:00:00	316.49
09/10/2019	13.09		6.52	0.00	00:00:00	00:00:00	24.54	0.00	00:00:00	34.25	0.00	00:00:00	5.30	00:00:00	314.61
10/10/2019	13.95		6.76	0.00	00:00:20	00:00:00	24.18	0.00	00:00:00	54.32	0.00	00:00:00	7.59	00:26:40	335.14
11/10/2019	11.45		6.87	0.00	00:00:00	00:00:00	23.68	0.00	00:00:00	67.22	0.00	00:00:00	7.19	00:27:00	273.46
12/10/2019	11.16		6.72	0.00	00:00:00	00:00:00	24.85	0.00	00:00:00	83.34	0.00	00:00:00	4.15	00:00:00	268.14
13/10/2019	10.97		6.83	0.00	00:00:00	00:00:00	25.86	0.00	00:00:00	100.67	0.00	00:00:00	6.63	00:00:00	263.70
14/10/2019	11.83		6.90	0.00	00:00:00	00:00:00	25.29	0.00	00:00:00	89.16	0.00	02:54:10	17.01	02:54:10	282.44
15/10/2019	11.36		7.02	0.00	00:00:00	00:00:00	24.56	0.00	00:00:00	32.11	0.00	00:26:10	51.64	00:26:10	272.89
16/10/2019	11.51		6.90	0.00	00:07:50	00:00:00	23.50	0.00	00:00:00	19.54	0.00	00:00:00	7.45	00:00:00	276.56
17/10/2019	18.69		6.85	0.00	00:00:00	00:00:00	23.16	0.00	00:00:00	33.94	0.00	00:00:00	4.77	00:00:00	448.56
18/10/2019	14.82		6.90	0.00	00:00:00	00:00:00	24.17	0.00	00:00:00	44.70	0.00	00:00:00	5.13	00:00:00	355.49
19/10/2019	13.91		6.74	0.00	00:00:00	00:00:00	24.22	0.00	00:00:00	46.44	0.00	00:00:00	5.63	00:00:00	334.33
20/10/2019	13.16		6.70	0.00	00:03:10	00:00:00	22.94	0.00	00:00:00	56.80	0.00	00:00:00	5.30	00:00:00	316.03
21/10/2019	14.10		6.91	0.00	00:00:00	00:00:00	22.90	0.00	00:00:00	63.60	0.00	00:00:00	3.49	00:00:00	338.32
22/10/2019	13.22		6.86	0.00	00:00:00	00:00:00	22.63	0.00	00:00:00	74.17	0.00	00:00:00	4.00	00:00:00	317.81
23/10/2019	16.67		6.82	0.00	00:00:00	00:00:00	23.34	0.00	00:05:50	89.32	0.00	00:00:00	2.80	00:00:00	400.16
24/10/2019	15.52		6.57	0.00	00:00:00	00:00:00	22.73	0.00	00:00:00	108.23	0.00	00:00:00	3.60	00:00:00	372.42
25/10/2019	15.39		6.46	0.00	00:00:00	00:00:00	23.15	0.00	00:00:00	63.21	0.00	00:00:00	5.28	00:00:00	369.55
26/10/2019	14.02		6.65	0.00	00:00:00	00:00:00	23.28	0.00	00:00:00	26.47	0.00	00:00:00	6.48	00:00:00	336.52
27/10/2019	13.21		6.46	0.00	00:00:00	00:00:00	23.14	0.00	00:00:00	29.37	0.00	00:00:00	5.18	00:00:00	330.86
28/10/2019	13.38		6.30	0.00	00:00:00	00:00:00	21.83	0.00	00:00:00	36.99	0.00	00:00:00	7.27	00:00:00	321.19
29/10/2019	15.57		6.29	0.00	00:00:00	00:00:00	21.99	0.00	00:00:00	56.60	0.00	00:00:00	12.98	01:14:20	373.73
30/10/2019	14.23		6.50	0.00	00:00:00	00:00:00	21.76	0.00	00:00:00	79.77	0.00	00:00:00	4.59	00:00:00	341.34
31/10/2019	16.68		6.56	0.00	00:00:00	00:00:00	22.89	0.00	00:00:00	61.52	0.00	00:00:00	4.62	00:00:00	399.69
Max:	18.69		7.02	0.00	00:00:00	00:00:00	25.92	0.00	00:00:00	108.23	0.00	00:00:00	17.01	00:00:00	448.56
Min:	10.97		6.17	0.00	00:00:00	00:00:00	21.76	0.00	00:00:00	19.54	0.00	00:00:00	1.86	00:00:00	263.70
Dep. Seuil Jour			0	0	0	0	0	0	0	0	0	0	0	0	0
Nb Jour Java.			0	0	0	0	0	0	0	0	0	0	0	0	0
Dep. Seuil Max	00:05		00:05	00:00	00:00	00:00	00:00	00:00	00:00	00:00	00:00	00:00	00:00	00:00	00:00
Dep. Seuil Min	00:11		00:11	00:11:20	00:11:20	00:05:50	23.86	0.00	00:00:00	55.46	0.00	00:00:00	6.22	07:58:10	100:02:73
Moy./Tot.	13.48		6.67	0.00	00:11:20	00:05:50	23.86	0.00	00:00:00	55.46	0.00	00:00:00	6.22	07:58:10	399.69

Rapport Rejet AQ Mensuel

Rapport Mensuel																	Novembre 2019		
Rejet Liquide																			
Unité	Debit	Ph	Volume Ph Inf/Dep	Temp Ph Inf/Dep	Volume Ph Sup/Dep	Temp Ph Sup/Dep	Temperature	Volume Temperature	Temp Temperature	Turbidité	Volume Turbid/Temp Turbidité	Temp Turbid/Temp Turbidité	Volume CO2	Temp CO2	Marche Rejets	Volume Rejet			
m ³ /h	m ³		hh:mm:ss	hh:mm:ss	m ³	hh:mm:ss	degreeC	m ³	hh:mm:ss	mg/l	m ³	hh:mm:ss	mg/l	hh:mm:ss	hh:mm:ss	m ³			
Dep. Seuil Min	8.5	5.5					30				400		40						
01/11/2019	15.49		00:00:00	00:00:00	0.00	00:00:00	23.61	0.00	00:00:00	65.76	0.00	00:00:00	0.00	00:00:00	24:00:00	372.15			
02/11/2019	14.49	6.48	00:00:00	00:00:00	0.00	00:00:00	23.82	0.00	00:00:00	77.64	0.00	00:00:00	0.00	00:00:00	24:00:00	348.20			
03/11/2019	12.84	6.70	00:00:00	00:00:00	0.00	00:00:00	23.55	0.00	00:00:00	80.21	0.00	00:00:00	0.00	00:00:00	24:00:00	307.82			
04/11/2019	13.31	6.98	00:00:00	00:00:00	0.00	00:00:00	23.23	0.00	00:00:00	86.58	0.00	00:00:00	0.00	00:00:00	24:00:00	319.21			
05/11/2019	16.31	7.64	00:00:00	00:00:00	0.00	00:21:40	22.04	0.00	00:00:00	101.07	0.00	00:00:00	0.00	00:25:20	24:00:00	391.95			
06/11/2019	16.64	6.84	00:00:10	00:00:00	0.38	00:00:00	22.29	0.00	00:00:00	114.12	0.00	00:00:00	0.00	00:00:00	24:00:00	399.30			
07/11/2019	15.32	7.45	00:00:00	00:00:00	0.00	01:44:00	22.62	0.00	00:00:00	132.20	0.00	00:00:00	0.00	00:00:00	24:00:00	367.33			
08/11/2019	14.67	7.52	00:00:00	00:00:00	0.00	00:32:40	22.57	0.00	00:00:00	148.68	0.00	00:00:00	0.00	00:00:00	24:00:00	352.80			
09/11/2019	13.15	6.77	00:00:00	00:00:00	0.00	00:00:10	22.71	0.00	00:00:00	148.05	0.00	00:00:00	0.00	00:00:00	24:00:00	315.60			
10/11/2019	13.91	6.34	00:00:00	00:00:00	85.20	00:00:00	22.20	0.00	00:00:00	127.74	0.00	00:00:00	0.00	00:00:00	24:00:00	333.65			
11/11/2019	14.40	6.77	00:00:00	00:00:00	2.30	00:00:00	20.65	0.00	00:00:00	135.29	0.00	00:00:00	0.00	00:00:00	24:00:00	315.60			
12/11/2019	11.47	7.31	00:00:00	00:00:00	10.94	01:01:00	20.09	0.00	00:00:00	153.78	0.00	00:00:00	0.00	00:25:40	24:00:00	345.79			
13/11/2019	9.91	6.75	00:00:00	00:00:00	8.99	00:00:00	20.91	0.00	00:00:00	169.06	0.00	00:00:00	0.00	00:00:00	24:00:00	275.39			
14/11/2019	13.15	7.05	00:00:00	00:00:00	1.70	00:00:00	21.11	0.00	00:00:00	162.89	0.00	00:00:00	0.00	00:00:00	23:50:00	236.00			
15/11/2019	13.41	6.98	00:00:00	00:00:00	0.00	00:00:00	20.45	0.00	00:00:00	130.26	0.00	00:00:00	0.00	00:00:00	24:00:00	315.18			
16/11/2019	8.61	6.21	00:00:00	00:00:00	0.00	00:00:00	22.91	0.00	00:00:00	104.30	0.00	00:00:00	0.00	00:00:00	24:00:00	321.56			
17/11/2019	10.60	5.80	00:00:00	00:00:00	31.38	00:00:00	22.57	0.00	00:00:00	105.26	0.00	00:00:00	0.00	00:00:00	24:00:00	207.37			
18/11/2019	11.31	6.14	00:00:00	00:00:00	34.28	00:00:30	22.84	0.00	00:00:00	118.21	0.00	00:00:00	0.00	00:00:00	24:00:00	254.39			
19/11/2019	11.52	6.35	00:00:00	00:00:00	0.51	00:00:00	22.14	0.00	00:00:00	63.34	0.00	00:00:00	0.00	00:00:00	24:00:00	276.74			
20/11/2019	11.69	6.76	00:00:00	00:00:00	0.00	00:52:20	22.42	0.00	00:00:00	45.94	0.00	00:00:00	0.00	00:00:00	24:00:00	280.66			
21/11/2019	11.64	6.57	00:00:00	00:00:00	0.00	00:00:00	20.97	0.00	00:00:00	59.05	0.00	00:00:00	0.00	00:00:00	24:00:00	279.47			
22/11/2019	11.80	6.32	00:00:00	00:00:00	0.00	00:00:00	22.56	0.00	00:00:00	69.17	0.00	00:00:00	0.00	00:10:00	24:00:00	283.34			
23/11/2019	10.84	6.05	00:00:00	00:00:00	0.00	00:00:00	23.68	0.00	00:00:00	81.91	0.00	00:00:00	0.00	00:00:00	24:00:00	260.17			
24/11/2019	10.21	6.49	00:00:00	00:00:00	0.00	00:00:00	23.24	0.00	00:00:00	91.62	0.00	00:00:00	0.00	00:00:00	24:00:00	245.21			
25/11/2019	10.81	6.03	00:00:00	00:00:00	16.12	00:00:00	23.29	0.00	00:00:00	62.56	0.00	00:00:00	0.00	00:52:40	24:00:00	259.72			
26/11/2019	12.47	6.27	00:00:00	00:00:00	4.36	00:00:00	23.28	0.00	00:00:00	44.79	0.00	00:00:00	0.00	00:47:20	24:00:00	298.90			
27/11/2019	11.26	6.20	00:00:00	00:00:00	0.00	00:00:00	23.24	0.00	00:00:00	59.54	0.00	00:00:00	0.00	00:00:00	24:00:00	270.74			
28/11/2019	11.83	6.15	00:00:00	00:00:00	0.91	00:00:00	23.96	0.00	00:00:00	53.36	0.00	00:00:00	0.00	00:00:00	24:00:00	284.00			
29/11/2019	14.46	6.34	00:00:00	00:00:00	15.25	00:00:00	23.68	0.00	00:00:00	41.79	0.00	00:00:00	0.00	00:00:00	24:00:00	347.34			
30/11/2019	10.57	6.26	00:00:00	00:00:00	9.09	00:00:00	24.76	0.00	00:00:00	40.72	0.00	00:00:00	0.00	00:00:00	24:00:00	253.59			
Max.	16.64	7.64	0.00	0.00	85.20	00:00:00	24.76	0.00	0.00	169.06	0.00	0.00	12.76	6.25	00:00:00	399.30			
Min.	8.61	5.80	0.00	0.00	0.00	00:00:00	20.09	0.00	0.00	40.72	0.00	0.00	0.71	0.00	00:00:00	207.37			
Dep. Seuil Jour	0	0	0	0	0	0	0	0	0	0	0	0	0	0	0	0			
Nb Jour Inva.	0	0	0	0	0	0	0	0	0	0	0	0	0	0	0	0			
Dep. Seuil Max	04:35						00:00												
Dep. Seuil Min	1j 00:16						00:00												
Moy./Tot.	12.60	6.60	0.00	1j 00:19:06	247.44	04:32:26	22.58	0.00	00:00:00	95.81	0.00	00:00:00	4.30	21.62	02:41:00	29j 23:50:00	9074.99		

Rapport Rejet AQ Mensuel

Rapport Mensuel															Decembre 2019		
Rejet Inquiné																	
Debit	Ph	Volumé Ph Inf/Dep.	Temp Ph Inf/Dep.	Volumé Ph Sup/Dep.	Temp Ph Sup/Dep.	Temperature	Volumé Temperature	Turbidité	Volumé Turbid.	Temp Turbidité	Volumé CO2 Dep.	Temp CO2 Dep.	Marché/Rejet	Volumé Rejet			
Unité m3/h		m3	Mh:mm:ss	m3	Mh:mm:ss	degreC	m3	mg/l	m3	Mh:mm:ss	m3	Mh:mm:ss	Mh:mm:ss	m3			
Seuil Jour	8.5						30	600			40						
Seuil Max	5.5																
Seuil Min																	
01/12/2019	10.93	6.08	0.00	02:10:00	17:50	00:00:00	23.99	44.40	0.00	00:00:00	2.87	8.27	00:25:10	24:00:00	262.40		
02/12/2019	12.73	6.38	0.00	00:28:20	7:52	00:00:00	24.03	33.63	0.00	00:00:00	2.95	0.00	00:00:00	24:00:00	305.73		
03/12/2019	12.44	6.63	0.00	00:07:20	1:30	00:00:00	22.64	22.85	0.00	00:00:00	1.61	0.00	00:00:00	24:00:00	298.61		
04/12/2019	12.49	6.42	0.00	00:27:20	2:90	00:00:00	22.51	23.01	0.00	00:00:00	1.40	0.00	00:00:00	24:00:00	299.61		
05/12/2019	11.57	6.01	0.00	01:29:50	11:66	00:00:00	22.43	23.32	0.00	00:00:00	1.63	0.00	00:00:00	24:00:00	277.76		
06/12/2019	12.92	6.75	0.00	00:00:00	0.00	00:00:00	25.25	24.04	0.00	00:00:00	1.71	0.00	00:00:00	24:00:00	309.95		
07/12/2019	12.59	7.02	0.00	00:00:00	0.00	00:00:00	23.37	25.70	0.00	00:00:00	1.42	0.00	00:00:00	24:00:00	302.53		
08/12/2019	10.46	6.91	0.00	00:00:00	0.00	00:00:00	23.99	28.75	0.00	00:00:00	2.02	0.00	00:00:00	24:00:00	251.28		
09/12/2019	11.29	6.63	0.00	00:00:00	0.00	00:00:00	24.82	38.39	0.00	00:00:00	4.68	17.51	01:14:20	24:00:00	271.25		
10/12/2019	11.62	6.81	0.00	00:00:00	0.00	00:00:00	22.79	37.85	0.00	00:00:00	4.71	9.84	00:51:00	24:00:00	279.28		
11/12/2019	10.60	6.63	0.00	00:00:00	0.00	00:00:00	22.75	31.58	0.00	00:00:00	2.76	3.37	00:20:10	24:00:00	254.99		
12/12/2019	12.60	6.66	0.00	00:00:00	0.00	00:00:00	21.87	40.19	0.00	00:00:00	3.50	7.41	00:26:30	24:00:00	302.39		
13/12/2019	14.19	6.57	0.00	00:00:00	0.00	00:00:00	23.15	68.93	0.00	00:00:00	3.24	0.00	00:00:00	24:00:00	340.37		
14/12/2019	11.38	6.22	0.00	00:00:00	0.00	00:00:00	24.24	80.87	0.00	00:00:00	1.94	0.00	00:00:00	24:00:00	302.39		
15/12/2019	9.84	6.11	0.00	00:00:00	0.00	00:00:00	23.99	69.15	0.00	00:00:00	3.66	0.00	00:00:00	24:00:00	273.58		
16/12/2019	10.43	6.22	0.00	00:00:00	0.00	00:00:00	24.24	78.57	0.00	00:00:00	1.28	0.00	00:00:00	24:00:00	236.50		
17/12/2019	10.57	7.04	0.00	00:00:00	0.00	00:00:00	22.29	47.10	0.00	00:00:00	10.86	2.04	00:07:50	24:00:00	250.20		
18/12/2019	8.85	7.27	0.00	00:22:50	1:81	00:00:00	22.33	32.96	0.00	00:00:00	4.88	9.07	00:44:10	24:00:00	254.05		
19/12/2019	14.01	6.68	0.00	00:00:00	0.00	00:00:00	23.21	36.66	0.00	00:00:00	8.36	11.46	00:51:00	24:00:00	212.66		
20/12/2019	12.08	6.66	0.00	01:24:30	10:24	00:43:50	23.89	42.83	0.00	00:00:00	9.66	0.00	00:00:00	24:00:00	336.47		
21/12/2019	11.67	6.88	0.00	00:00:00	0.00	00:00:00	24.44	45.35	0.00	00:00:00	4.04	0.00	00:00:00	24:00:00	290.09		
22/12/2019	9.81	6.77	0.00	00:00:00	0.00	00:00:00	23.69	59.80	0.00	00:00:00	5.69	0.00	00:00:00	24:00:00	235.85		
23/12/2019	10.37	6.46	0.00	00:00:00	0.00	00:00:00	23.31	70.75	0.00	00:00:00	4.29	0.00	00:00:00	24:00:00	249.09		
24/12/2019	10.66	7.06	0.00	00:00:00	0.00	00:00:00	22.74	47.72	0.00	00:00:00	3.32	0.00	00:00:00	24:00:00	255.80		
25/12/2019	9.98	7.22	0.00	00:00:00	0.00	00:00:00	23.25	30.72	0.00	00:00:00	2.63	0.00	00:00:00	24:00:00	259.52		
26/12/2019	9.14	7.19	0.00	00:00:00	0.00	00:00:00	22.90	38.32	0.00	00:00:00	1.98	0.00	00:00:00	24:00:00	239.52		
27/12/2019	11.43	7.72	0.00	00:00:00	0.00	00:00:00	22.41	37.29	0.00	00:00:00	6.36	3.09	00:24:30	24:00:00	219.65		
28/12/2019	11.49	7.66	0.00	00:00:00	0.00	00:00:00	22.73	45.47	0.00	00:00:00	6.34	0.00	00:00:00	24:00:00	274.37		
29/12/2019	9.42	7.31	0.00	00:00:00	0.00	00:00:00	21.80	53.44	0.00	00:00:00	3.48	0.00	00:00:00	24:00:00	275.28		
30/12/2019	8.68	7.33	0.00	00:08:20	0:60	00:40:20	21.45	79.73	0.00	00:00:00	7.94	4.20	00:24:50	24:00:00	226.67		
31/12/2019	10.52	8.12	0.00	00:00:00	0.00	07:26:30	19.93	57.11	0.00	00:00:00	16.84	2.37	00:26:20	24:00:00	208.45		
Max.	14.19	8.12	0.00		17:50		25.25	80.87	0.00		16.84	17.51			340.37		
Min.	8.68	6.01	0.00		0:00		19.93	22.85	0.00		1.28	0.00			208.45		
Dep. Seuil Jour																	
Nb Jour Inva.	0	0	0	0	0	0	0	0	0	0	0	0	0	0	0		
Dep. Seuil Max	09:42																
Dep. Seuil Min	06:35																
Moy/Tot.	11.19	6.82	0.00	06:39:16	54:04	09:42:10	23.02	45.05	0.00	00:00:00	4.45	78.63	06:15:50	311:00:00:00	8328.10		

the 1990s, the number of people in the UK who are employed in the public sector has increased from 10.5 million to 12.5 million, and the number of people in the public sector who are employed in health care has increased from 2.5 million to 3.5 million (Department of Health 2000).

There are a number of reasons for the increase in the number of people employed in the public sector. One reason is that the public sector has become a major employer in the UK. Another reason is that the public sector has become a major employer in the health care sector. A third reason is that the public sector has become a major employer in the education sector. A fourth reason is that the public sector has become a major employer in the social care sector.

The increase in the number of people employed in the public sector has led to a number of challenges for the public sector. One challenge is that the public sector has become a major employer in the health care sector, and this has led to a number of challenges for the health care sector. Another challenge is that the public sector has become a major employer in the education sector, and this has led to a number of challenges for the education sector. A third challenge is that the public sector has become a major employer in the social care sector, and this has led to a number of challenges for the social care sector.

One of the challenges for the health care sector is that the public sector has become a major employer in the health care sector, and this has led to a number of challenges for the health care sector. Another challenge is that the public sector has become a major employer in the education sector, and this has led to a number of challenges for the education sector. A third challenge is that the public sector has become a major employer in the social care sector, and this has led to a number of challenges for the social care sector.

One of the challenges for the education sector is that the public sector has become a major employer in the education sector, and this has led to a number of challenges for the education sector. Another challenge is that the public sector has become a major employer in the social care sector, and this has led to a number of challenges for the social care sector. A third challenge is that the public sector has become a major employer in the health care sector, and this has led to a number of challenges for the health care sector.

One of the challenges for the social care sector is that the public sector has become a major employer in the social care sector, and this has led to a number of challenges for the social care sector. Another challenge is that the public sector has become a major employer in the health care sector, and this has led to a number of challenges for the health care sector. A third challenge is that the public sector has become a major employer in the education sector, and this has led to a number of challenges for the education sector.

One of the challenges for the health care sector is that the public sector has become a major employer in the health care sector, and this has led to a number of challenges for the health care sector. Another challenge is that the public sector has become a major employer in the education sector, and this has led to a number of challenges for the education sector. A third challenge is that the public sector has become a major employer in the social care sector, and this has led to a number of challenges for the social care sector.

One of the challenges for the education sector is that the public sector has become a major employer in the education sector, and this has led to a number of challenges for the education sector. Another challenge is that the public sector has become a major employer in the social care sector, and this has led to a number of challenges for the social care sector. A third challenge is that the public sector has become a major employer in the health care sector, and this has led to a number of challenges for the health care sector.

One of the challenges for the social care sector is that the public sector has become a major employer in the social care sector, and this has led to a number of challenges for the social care sector. Another challenge is that the public sector has become a major employer in the health care sector, and this has led to a number of challenges for the health care sector. A third challenge is that the public sector has become a major employer in the education sector, and this has led to a number of challenges for the education sector.

4. Bilan des mesures semestrielles

Date des essais	Seuil	1er SEMESTRE -			2eme SEMESTRE -		
		FOUR 1 Valeur	FOUR 2 Valeur	FOUR DAS Valeur	FOUR 1 Valeur	FOUR 2 Valeur	FOUR DAS Valeur
Vitesse	>15 m/sec (L1&L2) >12m/sec (DAS)	26/03/2019 18,40	01/04/2019 18	19/03/2019 12,3	23/10/2019 17,9	24/10/2019 17,5	22/10/2019 8,4
Débit sec	Nm3/h	87 900	86 200	19 400	87 200	89 300	16 000
Température	°C	161	157	120	153	160	133
CO2	%/ sec	9,40	9,7	7	9,9	10,4	8,80
O2	%/ sec	10,20	10,10	11,9	9,7	9,3	9,6
Humidité	%	15,5	15,4	3,5	17,6	14,4	3,1
Poussières	< 10 mg/Nm3	5,10	3,30	0,58	3,00	5,40	1,70
CO	< 50 mg/Nm3	5,1	11,5	10,4	12,9	7,4	2,6
SO2	< 50 mg/Nm3	0,4	0,741	2	0,24	5,5	0,88
NOx	80mg/Nm3 (L1&L2) 100mg/Nm3 (DAS)	49,4	71,9	77,7	55	74,7	81,2
COVt	< 10 mg/Nm3	0,50	< 0,100	0,50	7,20	0,30	0,00
HCl	< 10 mg/Nm3	0,8	1,10	11,20	0,89	3,00	11,60
HF	< 1,0 mg/Nm3	0,00135	0,00130	0,00142	0,0041	0,027	0,041
NH3	< 10 mg/Nm3	2,3	0,188	3,2	0,37	0,199	1,5
Hg	< 0,05mg/Nm3	0,0087	0,0140	0,0276	0,03090	0,0675	0,0113
Σ Pb + Cr + Cu + Mn+Ni+V+Co+As+Sb	< 0,5mg/Nm3	0,0358	0,0424	0,0026	0,0552	0,1510	0,0213
Cd + Tl	< 0,05mg/Nm3	0,0019	0,0022	0	0,0041	0,0070	0,0000049
Dioxines et furanes	< 0,1 ng/Nm3	0,076	0,0269	0,0035	0,01000	0,00721	0,0032

COMMENTAIRES

Semestre 1 : Dépassement de la moyenne journalière en HCl de la ligne DAS à 11,2 mg/Nm3 (pour un seuil à 10mg/Nm3). Cf fiche d'incident N° 19/009.

Semestre 2:

* Dépassement de la moyenne journalière en HCl de la ligne DAS à 11,6 mg/Nm3 (pour un seuil à 10) lors du contrôle réglementaire (cf.fiche d'incident N° 20/002).
* Dépassements sur la ligne N°2: de la valeur flux/jour en NOx sur la ligne n°2 à 160 kg/j (pour un seuil à 153,6 kg/j), en concentration mercure à 67,5 µg/Nm3 (pour un seuil à 50 µg/Nm3) et en flux mercure à 144 g/j (pour un seuil à 96 g/j) (cf.fiche d'incident N° 20/003).

5. Analyses EMERAUDE

5.1. Analyses mâchefers

5.2. Analyses cendres

5.3. Analyses boues (gâteaux de filtre presse)

ANALYSES DES CENDRES EMERAUDE

2019

	Unité	TRIMESTRE 1	TRIMESTRE 2	TRIMESTRE 3	TRIMESTRE 4
Date de prélèvement		27/02/2019	20/05/2019	28/08/2019	20/11/2019
N° rapport analyse		SOC1902-3060	SOC1905-2255	SOC1908-2913	SOC1911-2319
Humidité	%	1,6	0,2	< 0,1	0,4
pH		12,20	12,60	12,35	12,65
COT	mg/kg	< 30,00	< 30,0	< 30,0	< 30,0
Fraction soluble	%	50,254	38,395	43,640	41,501
DCO	mg/kg	2 500,00	1 900,00	4010,00	< 2500,0
Sulfates	mg/kg	41 391,0	44 124,00	34 930	36 082
Chrome VI	mg/kg	22,99	7,83	7,32	12,23
Manganèse	mg/kg	< 0,01	0,02	< 0,010	< 0,010
Nickel	mg/kg	< 0,05	< 0,050	< 0,050	< 0,050
Plomb	mg/kg	175,33	608,12	437,50	395,37
Cadmium	mg/kg	0,200	0,406	0,545	0,181
Arsenic	mg/kg	0,02	0,020	0,02	0,02
Mercure	mg/kg	0,0183	0,0075	0,0022	0,0063

ANALYSES DES GATEAUX EMERAUDE
2019

	<i>Unité</i>	TRIMESTRE 1	TRIMESTRE 2	TRIMESTRE 3	TRIMESTRE 4
Date de prélèvement		27/02/2019	20/05/2019	28/08/2019	20/11/2019
N° rapport analyse		SOC1902-3062	SOC1905-2253	SOC1908-2912	SOC1911-2316
Humidité	%	43	49,3	44,4	41,9
Perte au feu	%	8,3	50,7	4,6	10,3
pH		11,85	8,55	9,2	7,35
COT	mg/Kg	30	< 30	< 30	30
Fraction soluble	%	6,041	5,916	4,407	3,686
Cyanures	mg/Kg	< 0,10	< 0,10	< 0,10	< 0,10
Chrome	mg/kg	0,17	< 0,05	< 0,05	< 0,05
Nickel	mg/Kg	< 0,05	< 0,05	< 0,05	< 0,05
Plomb	mg/Kg	< 0,05	< 0,05	< 0,05	< 0,05
Zinc	mg/kg	< 0,50	< 0,05	< 0,50	< 0,50
Cadmium	mg/Kg	< 0,005	< 0,005	< 0,005	< 0,005
Arsenic	mg/Kg	< 0,01	< 0,01	< 0,01	< 0,01
Chrome VI	mg/Kg	0,12	< 0,05	< 0,05	< 0,050
Mercuré	mg/Kg	< 0,01	< 0,01	< 0,01	< 0,01

6. Analyses DAS

6.1. Analyses cendres

6.2. Analyses boues (gâteaux de filtre presse)

ANALYSES DES CENDRES DAS

2019

	Unité	TRIMESTRE 1	TRIMESTRE 2	TRIMESTRE 3	TRIMESTRE 4
Date de prélèvement		27/02/2019	20/05/2019	28/08/2019	20/11/2019
N° rapport analyse		SOC1902-3059	SOC1905-2255	*	SOC1911-2318
Humidité	%	0,6	0,6		0,4
pH		6,75	6,95		10,40
COT	mg/kg	< 30,00	< 30,00		33,00
Fraction soluble	%	14,4	14,6		25,0
DCO	mg/kg	290,00	450,00		< 2500
Sulfates	mg/kg	54 060,0	55 474,0		34 890
Chrome VI	mg/kg	0,15	0,11		2,520
Manganèse	mg/kg	102,59	104,53		0,02
Nickel	mg/kg	2,20	< 2,26		< 0,050
Plomb	mg/kg	9,73	12,14		0,390
Cadmium	mg/kg	7,623	7,228		0,014
Arsenic	mg/kg	< 0,01	0,01		< 0,020
Mercuré	mg/kg	< 0,001	< 0,001		< 0,003

* Ligne DAS à l'arrêt (Arrêt technique annuel)

ANALYSES DES GATEAUX D.A.S.
2019

	Unité	TRIMESTRE 1	TRIMESTRE 2	TRIMESTRE 3	TRIMESTRE 4
Date de prélèvement		27/02/2019	20/05/2019	28/08/2019	20/11/2019
N° rapport analyse		SOC1902-3061	SOC1905-2254	SOC 1908-2909	SOC1911-2315
Humidité	%	60,4	51,9	29,9	58,4
Perte au feu	%	15	48,1	14,4	3,8
pH		9,70	9,45	8,75	9,75
COT	mg/Kg	< 30	< 30	210	< 30
Fraction soluble	%	3,988	5,127	9,092	3,307
Cyanures	mg/Kg	0,10	< 0,10	< 0,10	< 0,10
Chrome	mg/kg	< 0,05	< 0,05	< 0,09	0,06
Nickel	mg/Kg	< 0,05	< 0,05	< 0,05	< 0,05
Plomb	mg/Kg	< 0,05	< 0,05	< 0,05	< 0,05
Zinc	mg/kg	< 0,50	< 0,50	< 0,50	< 0,50
Cadmium	mg/Kg	< 0,005	< 0,005	< 0,005	0,006
Arsenic	mg/Kg	< 0,01	< 0,01	< 0,01	< 0,01
Chrome VI	mg/Kg	< 0,05	< 0,05	0,09	0,05
Mercure	mg/Kg	0,09	2,60	0,19	3,03

7. Analyse légionnelles tours aéro : EMERAUDE et JACIR

Date	Echantillon	Nom et société du préleveur	Micro organisme recherché	Concentration en micro organisme	Références	T° C	Conductivité (µS/cm)	Turbidité (NFU)	pH	OBSERVATIONS
mercredi 3 juillet 2019	TOUR 0530	CELLES-BLAISE	Legionella pneumophila	<100 UFC/l	HA19-12113	18,5	282,6	14,4	8,05	Rapport reçu le 17/07/2019
	TOUR 0531	Voie Sèche								
	TOUR 0532	CELLES-BLAISE	Legionella pneumophila	<100 UFC/l	HA19-12114	18	164,5	3,88	7,71	Rapport reçu le 17/07/2019
mercredi 3 juillet 2019	JACIR	CELLES-BLAISE	Legionella pneumophila	<100 UFC/l	2019-12115	32,5	130,5	2,7	7,5	
vendredi 9 août 2019	TOUR 0530	BALOGOUN	Legionella pneumophila	<100 UFC/l	HA19-14778	22,4	419	15,2	8,02	Rapport reçu le 21/08/2019
	TOUR 0531	Voie Sèche								
	TOUR 0532	BALOGOUN	Legionella pneumophila	<100 UFC/l	HA19-14777	20,9	115,7	3,04	7,73	Rapport reçu le 21/08/2019
vendredi 9 août 2019	JACIR	BALOGOUN	Legionella pneumophila	<100 UFC/l	2019-14776	32,5	121,8	2,88	7,65	Rapport reçu le 21/08/2019
jeudi 5 septembre 2019	TOUR 0530	BALOGOUN	Legionella pneumophila	<100 UFC/l	2019-16465	17,4	176,6	54,1	8,6	Rapport reçu le 16/09/2019
	TOUR 0531	Voie Sèche								
	TOUR 0532	BALOGOUN	Legionella pneumophila	<100 UFC/l	2019-16461	16,8	40,64	4,44	8,8	Rapport reçu le 16/09/2019
mercredi 11 septembre 2019	JACIR	BALOGOUN	Legionella pneumophila	<100 UFC/l	2019-16829	29,1	128,8	6,78	7,83	Rapport reçu le 20/09/2019
vendredi 4 octobre 2019	TOUR 0530	BALAGOUNI	Legionella pneumophila	<100 UFC/l	2019-18963	17,2	384,8	22,6	7,66	Rapport reçu le 15/10/2019
	TOUR 0531	Voie Sèche								
jeudi 10 octobre 2019	TOUR 0532	BALAGOUNI	Legionella pneumophila	<100 UFC/l	2019-19362	16,7	178,5	9,58	7,6	Rapport reçu le 21/10/2019
vendredi 4 octobre 2019	JACIR	BALAGOUNI	Legionella pneumophila	<100 UFC/l	2019-18962	31,8	183,8	7,49	7,49	Rapport reçu le 15/10/2019
	TOUR 0530	Voie Sèche								
	TOUR 0531	Voie Sèche								
jeudi 7 novembre 2019	TOUR 0532	BALAGOUNI	Legionella pneumophila	<100 UFC/l	2019-22022	15,8	154,9	7,41	7,53	Rapport reçu le 20/11/2019
	JACIR	BALAGOUNI	Legionella pneumophila	<100 UFC/l	2019-21993	29,8	143,5	7,47	7,47	Rapport reçu le 20/11/2019
	TOUR 0530	Voie Sèche								
	TOUR 0531	Voie Sèche								
dimanche 22 décembre 2019	TOUR 0532	DANIEL	Legionella pneumophila	<100 UFC/l	2019-26171	13,5	160	1,6	7,47	Rapport reçu le 07/01/2020
lundi 2 décembre 2019	JACIR	DUTARTRE	Legionella pneumophila	<100 UFC/l	2019-24184	33,3	136,3	4,29	6,83	Rapport reçu le 12/12/2019

8. Consommation en eaux

Consommation en eaux

2019 	Eau de ville (m3)	Eau de forage (m3)
JANVIER	291,0	30 060
FEVRIER	391,4	30 660
MARS	594,5	32 732
AVRIL	524,1	30 870
MAI	604,0	30 994
JUIN	923,3	23 300
JUILLET	709,7	33 756
AOUT	749,5	29 708
SEPTEMBRE	491,9	35 604
OCTOBRE	434,6	34 114
NOVEMBRE	347,0	31 466
DECEMBRE	355,0	35 458
TOTAL	6 416	378 722
	385 138	
<u>Commentaires :</u>		

9. Analyse des rejets aqueux usine

Analyses	Seuil	JANVIER	FEBVRIER	MARS	AVRIL	MAI	JUIN	JUILLET	AOÛT	SEPTEMBRE	OCTOBRE	NOVEMBRE	DÉCEMBRE
Date de prélèvement		23/01/2019	27/02/2019	20/03/2019	17/04/2019	20/05/2019	19/06/2019	24/07/2019	28/08/2019	24/09/2019	16/10/2019	20/11/2019	18/12/2019
N° de rapport		SOCI1901-2390	SOCI1902-3085	SOCI1903-3386	SOCI1904-2791	SOCI1905-2236	SOCI1906-2142	SOCI19-3720	SOCI19-2917	SOCI1909-2951	SOCI1910-2405	SOCI1911-2340	SOCI1912-2733
pH	5,5 - 8,5	7,5	7,3	7,0	8,0	7,0	6,9	7,3	7,3	7,1	7,3	7,2	7,0
DCO	< 2000 mg/l	179	68	79	146	153	< 75	875	936	126	78	41	86
DBO5	< 800 mg/l	< 3	< 3	< 3	4	< 3	3	4	5	5	3	< 3	9
MES	< 600 mg/l						14,3					13,6	
COT	< 40 mg/l	6,4	< 3	5,6	27,7	4,9	5,4	7,3	6,2	6,2	6,9	5,5	11,7
Hydrocarbures totaux	< 5 mg/l	< 0,050	< 0,050	0,38	< 0,050	< 0,050	0,19	0,07	0,08	0,06	0,60	0,46	0,18
Cr6+	< 0,05mg/l	0,007				0,013						< 0,009	
Cd	< 0,025 mg/l	< 0,001	< 0,001	0,007	< 0,001	< 0,001	< 0,001	0,001	< 0,001	< 0,001	0,006	< 0,001	0,002
Pb	< 0,1 mg/l	< 0,005	< 0,005	< 0,005	< 0,005	< 0,005	< 0,005	0,006	0,006	0,005	0,006	< 0,005	< 0,005
Tl (thallium)	< 0,05 mg/l	< 0,05	< 0,05	< 0,05	< 0,05	< 0,05	< 0,05	< 0,05	< 0,05	< 0,05	< 0,05	< 0,05	< 0,05
Hg	< 0,025 mg/l	< 0,0002	0,0069	0,0113	0,0006	0,003	0,0089	0,129	0,0007	0,0045	0,0041	0,0018	0,0051
As	< 0,1 mg/l	< 0,001	< 0,001	< 0,001	< 0,001	< 0,001	< 0,001	< 0,001	< 0,001	< 0,001	0,0010	< 0,001	< 0,001
F	< 15 mg/l	10,08	11,13	5,26	7,45	10,21	8,04	11,04	7,84	9,38	4,88	9,17	6,92
CN	< 0,1 mg/l	< 0,01	< 0,010	< 0,01	< 0,01	< 0,01	< 0,01	< 0,01	< 0,010	< 0,010	< 0,010	< 0,010	< 0,010
AOX	< 5 mg/l	0,077	0,014	0,057	0,032	0,061	0,2030	0,2723	0,0650	0,3320	0,0805	0,5160	0,089
DIOXINES / FURANNES	< 0,3 ng/l					0,0043						0,0076	
Chlorures	mg/l					10 380						8 436	
Chrome Cr	< 0,1 mg/l	0,013	0,009	0,021	0,008	0,010	0,008	0,013	0,012	0,010	0,010	0,009	0,013
Cu	< 0,25 mg/l	< 0,005	< 0,005	< 0,005	< 0,005	< 0,005	< 0,005	< 0,005	< 0,005	0,005	< 0,005	< 0,005	0,007
Ni	< 0,1 mg/l	< 0,005	< 0,005	< 0,005	< 0,005	< 0,005	< 0,005	0,006	< 0,005	0,006	0,006	< 0,005	0,006
Zn	< 0,8 mg/l	0,032	0,023	0,029	0,026	0,031	0,071	0,129	0,081	0,061	0,132	0,052	0,047

Commentaires :

Le 24/07/2019, dépassement du seuil en mercure (Hg) à 0,129 mg/l pour un seuil à 0,025 mg/l sur les rejets liquides, dû à un problème de régénération du filtre à charbon sur les effluents de la ligne DAS (Cf. Fiche d'incident N° 19-012).

10. Fiches incidents

FICHE D'INCIDENT N°19/001

Date de l'incident : 08/04/2019

Date d'ouverture de la fiche : 09/04/2019

Destinataire :

- DRIEE Mail : mary-anne.mathieu@developpement-durable.gouv.fr
 Préfecture Fax 01 49 56 64 08..... (Tél 01 49 56 60 00)
 SMITDUVM Mail : kikenl@gpsea.fr et anvinois@gpsea
 Autres Fax Tél.....

Secteur de l'usine touché :

Heure : à

EMERAUDE

- Hall de déchargement
 Fosse
 Fours/chaudières
 Traitement fumées / effluent
 Bâtiment administratif
 Tours aéroréfrigérantes

DAS

- Hall de déchargement
 Bâtiment administratif
 Manutention
 Four /Chaudières
 Traitement fumés / effluent
 Tour aéroréfrigérante

AUTRE

- Rejet liquide usine
 Voies de circulation
 Environnement usine

Evaluation de la situation :

- Problème d'incendie
 Problème d'analyseur
 Problème de pollution
 Dégagement de fumées
 Dépassement de seuils polluants
 Dépassement du seuil en légionelles de 100 000 UFC/l
 Pollution accidentelle au niveau du stockage des produits
 Huile Fioul Autres :
- Impact sonore
 Impact visuel

Etat de la situation :

- Maîtrisé Non maîtrisé En cours de traitement
 PIOS déclenché Dégât matériel : Victime /état :

Origine du problème rencontré :

Dépassement de la valeur flux jour en POUSSIÈRE sur la ligne 2 à 19,471 Kg (pour un seuil à 19,2 Kg).

Non identifiée

Identifiée : Pour effectuer le contrôle réglementaire QAL2 des analyseurs, la société LECES a réalisé un dopage « volontaire » en poussière. Ce dopage a été trop important et a occasionné dans la journée plusieurs moyennes hautes de la mesure de poussière en cheminée.

Moyens déjà engagés : Prévenu LECES pour mieux ajuster le dopage et diminution de la charge de la ligne concernée.

Moyens complémentaires à demander : /

Pièces jointes : Rapports journalier du 08/04/2019

Nom, fonction et signature du déclarant :

Marie-Christine VIRATELLE, Directrice de Site



Rapport DREAL Flux Journalier Ligne 2

Rapport Flux Journalier										08 Avril 2019
FLUX Ligne 2										
VLE Flux Jour	Unité Kg	CO Kg	COT Kg	HCL Kg	NOx Kg	POUSSIÈRE Kg	SO2 Kg	NH3 Kg	MercheFourL2 MWh/années	
		57.61		19.2	19.2	153.4	19.2	96	13.3	
00:30	0.259	0.000	0.060	2.272	0.133	0.578	0.000	00:30:00		
01:00	0.262	0.000	0.062	2.651	0.125	0.520	0.000	00:30:00		
01:30	0.273	0.000	0.060	2.987	0.167	0.553	0.000	00:30:00		
02:00	0.292	0.000	0.057	3.250	0.274	0.658	0.000	00:30:00		
02:30	0.304	0.000	0.056	2.989	0.266	0.612	0.000	00:30:00		
03:00	0.284	0.000	0.053	3.061	0.360	0.607	0.000	00:30:00		
03:30	0.306	0.000	0.052	3.070	0.314	0.634	0.000	00:30:00		
04:00	0.303	0.000	0.050	3.063	0.375	0.643	0.000	00:30:00		
04:30	0.270	0.000	0.048	2.938	0.344	0.632	0.000	00:30:00		
05:00	0.298	0.000	0.047	2.703	0.328	0.632	0.000	00:30:00		
05:30	0.320	0.000	0.050	3.678	0.265	0.612	0.000	00:30:00		
06:00	0.309	0.000	0.047	3.025	0.295	0.670	0.000	00:30:00		
06:30	0.290	0.000	0.045	2.612	0.267	0.667	0.000	00:30:00		
07:00	0.267	0.000	0.044	2.605	0.272	0.706	0.000	00:30:00		
07:30	0.299	0.000	0.045	2.949	0.232	0.553	0.000	00:30:00		
08:00	0.300	0.000	0.046	2.811	0.269	0.597	0.000	00:30:00		
08:30	0.311	0.000	0.050	3.682	0.329	0.769	0.000	00:30:00		
09:00	0.335	0.000	0.057	2.264	0.287	0.709	0.000	00:30:00		
09:30	0.369	0.000	0.060	3.312	0.670	0.694	0.000	00:30:00		
10:00	0.412	0.000	0.054	2.639	0.518	0.745	0.000	00:30:00		
10:30	0.328	0.000	0.058	2.626	0.355	0.663	0.000	00:30:00		
11:00	0.384	0.000	0.060	2.902	1.336	0.656	0.000	00:30:00		
11:30	0.345	0.000	0.060	3.656	1.200	0.649	0.005	00:30:00		
12:00	0.304	0.000	0.061	2.724	0.994	0.557	0.010	00:30:00		
12:30	0.239	0.000	0.167	2.262	0.941	0.516	0.006	00:30:00		
13:00	0.245	0.000	0.268	2.709	1.009	0.414	0.005	00:30:00		
13:30	0.335	0.000	0.087	3.350	0.961	0.425	0.005	00:30:00		
14:00	0.363	0.000	0.052	3.382	1.042	0.591	0.009	00:30:00		
14:30	0.403	0.000	0.050	2.924	0.953	0.564	0.012	00:30:00		
15:00	0.412	0.000	0.058	3.009	0.920	0.557	0.013	00:30:00		
15:30	0.338	0.000	0.066	3.352	0.931	0.578	0.014	00:30:00		
16:00	0.320	0.000	0.083	2.329	0.778	0.557	0.012	00:30:00		
16:30	0.353	0.000	0.098	3.301	0.415	0.498	0.010	00:30:00		
17:00	0.353	0.000	0.057	3.128	0.351	0.533	0.013	00:30:00		
17:30	0.332	0.000	0.052	3.011	0.241	0.492	0.003	00:30:00		
18:00	0.288	0.000	0.055	2.925	0.255	0.445	0.000	00:30:00		
18:30	0.282	0.000	0.066	2.349	0.172	0.388	0.000	00:30:00		
19:00	0.214	0.000	0.062	1.885	0.135	0.299	0.000	00:30:00		
19:30	0.152	0.000	0.057	1.353	0.064	0.287	0.000	00:30:00		
20:00	0.159	0.000	0.053	1.361	0.042	0.248	0.000	00:30:00		
20:30	0.142	0.000	0.035	1.790	0.035	0.250	0.000	00:30:00		
21:00	0.166	0.000	0.030	1.768	0.034	0.247	0.000	00:30:00		
21:30	0.135	0.000	0.033	1.764	0.038	0.237	0.000	00:30:00		
22:00	0.147	0.000	0.034	1.368	0.037	0.205	0.000	00:30:00		
22:30	0.167	0.000	0.047	1.311	0.035	0.182	0.000	00:30:00		
23:00	0.161	0.000	0.036	1.527	0.036	0.196	0.000	00:30:00		
23:30	0.174	0.000	0.031	1.912	0.036	0.258	0.000	00:30:00		
00:00	0.161	0.000	0.031	1.824	0.035	0.249	0.000	00:30:00		
Min	0.135	0.000	0.030	1.311	0.034	0.182	0.000			
Max	0.412	0.000	0.268	3.682	1.336	0.769	0.014			
Cumul	13.465	0.000	2.890	125.363	19.471	24.532	0.117	24:00:00		
Dep VLE Flux Jour	0	0	0	0	1	0	0			

FICHE D'INCIDENT N°19/002

Date de l'incident : 07/06/2019

Date d'ouverture de la fiche : 11/06/2019

Destinataire :

- DRIEE Mail : mary-anne.mathieu@developpement-durable.gouv.fr
 Préfecture Fax 01 49 56 64 08..... (Tél 01 49 56 60 00)
 SMITDUVM Mail : kiken@gpsea.fr et amvinois@gpsea
 Autres Fax Tél.....

Secteur de l'usine touché :

Heure : à

EMERAUDE

- Hall de déchargement
 Fosse
 Fours/chaudières
 Traitement fumées / effluent
 Bâtiment administratif
 Tours aéroréfrigérantes

DAS

- Hall de déchargement
 Bâtiment administratif
 Manutention
 Four /Chaudières
 Traitement fumés / effluent
 Tour aéroréfrigérante

AUTRE

- Rejet liquide usine
 Voies de circulation
 Environnement usine

Evaluation de la situation :

- Problème d'incendie
 Problème d'analyseur
 Problème de pollution
 Dégagement de fumées
 Dépassement de seuils polluants
 Dépassement du seuil en légionelles de 100 000 UFC/l
 Pollution accidentelle au niveau du stockage des produits
 Huile Fioul Autres :
- Impact sonore
 Impact visuel

Etat de la situation :

- Maîtrisé Non maîtrisé En cours de traitement
 PIOS déclenché Dégât matériel : Victime /état :

Origine du problème rencontré :

Dépassement de la valeur moyenne jour en HCl sur la ligne DAS à 10,75 mg/Nm³ (pour un seuil à 10 mg/Nm³).

- Non identifiée
 Identifiée : Un manque d'injection de chaux dans le filtre à manches a provoqué des mesures hautes d'HCl en cheminée.

Moyens déjà engagés : Appoint du cône d'injection de chaux et augmenté la quantité injectée dans le filtre à manches.

Moyens complémentaires à demander : /

Pièces jointes : Rapports journalier du 07/06/2019

Nom, fonction et signature du déclarant :

Marie-Christine VIRATELLE, Directrice de Site



VALO'MARNE

10/11, rue des Malfourches
94034 CRETEIL Cedex
Tél. : 01.48.98.55.11
Fax : 01.48.98.48.83
SIRET : 833 921 232 00017

Rapport DREAL Journalier Ligne 4

Rapport journalier													07 Juin 2019	
Mesure IC95 Ligne4														
Unité	CO mg/Nm3	COT mg/Nm3	HCL mg/Nm3	NH3 mg/Nm3	NOX mg/Nm3	POUSSIERE mg/Nm3	SO2 mg/Nm3	Vitesse30 m/s	T4_2C °C	O2 %	T2R_30_L4 degreC	MoucheFourL4_10 h:min:se	Tonnage DASRI Tonne	
VLE 1/2h	100	20	60	20	30	300	12	300						
VLE max	100	20	60	20	30	300	12	300						
Seuil Min.	50	10	10	10	100	0	50							
VLE Jour	50	10	10	10	100	0	50							
00:30	0.51	0.00	8.50	0.41	139.40	1.165	5.96	20.93	11.80	1031.2	00:28:00	0.0		
01:00	0.34	0.00	9.69	0.32	119.58	1.152	6.47	17.61	11.76	1040.4	00:24:20	0.0		
01:30	1.27	0.00	10.58	0.29	98.59	1.165	6.40	17.89	11.80	1017.8	00:30:00	0.0		
02:00	0.46	0.00	7.57	0.32	110.85	1.162	4.63	18.52	11.91	1022.7	00:30:00	0.0		
02:30	0.83	0.00	9.37	0.38	107.23	1.178	4.51	20.09	11.94	1024.8	00:30:00	0.0		
03:00	0.47	0.00	8.28	0.40	118.89	1.217	5.03	21.65	12.17	1033.6	00:30:00	0.0		
03:30	1.38	0.00	9.24	0.30	64.06	1.166	7.24	16.21	11.86	998.6	00:28:00	0.0		
04:00	3.08	0.00	8.54	0.43	39.94	1.190	4.54	15.95	11.76	922.9	00:30:00	0.0		
04:30	3.28	0.00	7.88	0.51	61.16	1.158	4.92	19.14	11.80	993.2	00:30:00	0.0		
05:00	1.02	0.00	7.01	0.58	119.41	1.257	4.44	24.10	12.00	1030.8	00:30:00	0.0		
05:30	0.58	0.00	7.56	0.44	120.54	1.273	4.03	24.23	12.27	1031.5	00:30:00	0.0		
06:00	1.57	0.00	7.89	0.51	106.07	1.236	3.63	23.98	12.00	1020.4	00:30:00	0.0		
06:30	0.97	0.00	7.60	0.43	88.54	1.241	2.59	23.97	12.05	1018.2	00:30:00	0.0		
07:00	0.93	0.00	7.35	0.41	87.41	1.242	3.01	23.64	12.13	1018.9	00:30:00	0.0		
07:30	2.64	0.00	6.57	0.57	84.30	1.211	2.90	20.66	12.10	1001.1	00:30:00	0.0		
08:00	3.22	0.00	4.57	0.65	81.42	1.169	2.97	21.55	11.62	1004.7	00:26:30	0.0		
08:30	1.72	0.00	7.13	0.42	100.63	1.155	4.93	20.29	11.67	1021.2	00:30:00	0.0		
09:00	0.65	0.00	11.67	0.26	133.50	1.214	5.00	21.08	12.08	1043.2	00:30:00	0.0		
09:30	0.85	0.00	6.13	0.32	100.36	1.155	2.95	19.62	11.77	1027.3	00:30:00	0.0		
10:00	0.28	0.00	6.44	0.37	140.19	1.329	3.80	21.84	11.67	1049.3	00:30:00	0.0		
10:30	0.24	0.00	18.30	0.24	110.06	22.842	4.30	18.28	11.45	1033.1	00:30:00	0.0		
11:00	0.80	0.00	7.89	0.25	96.56	1.164	4.20	16.42	10.93	1029.3	00:30:00	0.0		
11:30	0.27	0.00	7.82	0.35	111.43	1.146	6.21	17.30	11.20	1037.9	00:30:00	0.0		
12:00	0.13	0.00	7.71	0.40	136.57	1.149	5.62	18.67	11.31	1042.4	00:30:00	0.0		
12:30	0.21	0.00	8.81	0.31	151.76	1.150	8.36	18.04	11.44	1043.6	00:30:00	0.0		
13:00	0.33	0.00	8.40	0.28	115.45	1.030	7.75	13.72	10.43	1028.4	00:30:00	0.0		
13:30	1.23	0.00	10.42	0.25	78.04	0.909	7.42	10.46	9.20	1010.9	00:30:00	0.0		
14:00	0.63	0.00	18.00	0.32	78.95	0.910	7.38	11.14	9.19	1024.1	00:30:00	0.0		
14:30	1.24	0.00	19.89	0.37	86.16	0.903	6.11	11.76	9.13	1028.8	00:30:00	0.0		
15:00	2.75	0.00	12.40	0.52	51.66	0.993	5.91	10.31	9.45	1000.8	00:30:00	0.0		
15:30	4.02	0.00	12.00	0.51	56.50	0.903	5.74	11.26	9.16	995.3	00:30:00	0.0		
16:00	0.79	0.00	16.74	0.61	69.28	0.953	6.51	15.17	9.67	1009.9	00:30:00	0.0		
16:30	0.13	0.00	11.61	0.63	152.16	1.005	10.53	18.40	9.86	1048.1	00:30:00	0.0		
17:00	0.22	0.00	7.75	0.58	163.33	1.145	9.81	20.26	11.15	1067.3	00:30:00	0.0		
17:30	35.93	0.80	6.88	0.43	114.85	1.068	11.25	18.68	10.08	1052.0	00:30:00	0.0		
18:00	1.55	0.00	6.58	0.60	59.00	1.124	11.27	15.59	11.26	1002.3	00:30:00	0.0		
18:30	1.78	0.00	6.79	0.38	48.42	0.903	11.14	11.05	9.08	988.6	00:30:00	0.0		
19:00	2.23	0.00	15.85	0.42	52.82	0.914	14.54	12.62	9.26	989.3	00:30:00	0.0		
19:30	1.48	0.00	25.65	0.52	72.75	0.930	15.90	14.11	9.23	1000.2	00:30:00	0.0		
20:00	0.55	0.00	23.45	0.76	105.77	0.997	5.94	18.24	9.89	1024.4	00:30:00	0.0		
20:30	0.74	0.00	16.73	0.85	73.58	1.105	3.18	18.02	11.16	1011.7	00:21:40	115.9		
21:00	Arrêt	Arrêt	Arrêt	Arrêt	Arrêt	Arrêt	Arrêt	Arrêt	Arrêt	Arrêt	00:00:00	0.0		
21:30	Arrêt	Arrêt	Arrêt	Arrêt	Arrêt	Arrêt	Arrêt	Arrêt	Arrêt	Arrêt	00:00:00	0.0		
22:00	Arrêt	Arrêt	Arrêt	Arrêt	Arrêt	Arrêt	Arrêt	Arrêt	Arrêt	Arrêt	00:17:00	0.0		
22:30	2.67	0.00	8.20	0.36	74.91	0.980	2.08	10.58	9.81	985.3	00:30:00	0.0		
23:00	2.02	0.00	15.69	0.35	62.67	0.914	2.42	11.55	9.03	990.0	00:30:00	0.0		
23:30	1.73	0.00	16.80	0.41	59.65	0.923	2.43	12.82	9.12	992.1	00:30:00	0.0		
00:00	1.39	0.00	12.50	0.60	65.48	1.021	2.37	15.06	9.49	1006.7	00:30:00	0.0		
Max.	35.93	0.80	25.65	0.85	163.33	22.842	14.54	24.23	12.27	1067.3		115.9		
Min.	0.13	0.00	4.57	0.24	39.94	0.903	3.08	10.31	9.02	985.3		0.0		
Moy/Cumul	2.02	0.02	10.75	0.43	98.68	1.878	8.98	17.41	10.87	1018.4	23:28:00	115.9		
Dép. VLE 1/2h	0	0	0	0	0	0	0							
Dép. VLE max	00:00	00:00				00:00								
Dép. Seuil Min.								04:00		00:00				
Indisponibilité	0	0	0	0	0	0	0	0	0	0	0	0		
% données HC	0.00	0.00	0.00	0.00	0.00	0.00	0.00	0.00	0.00	0.00	0	0.00		
Invalidité	0	0	0	0	0	0	0	0	0	0	0	0		
Dép. VLE Jour	0	0	0	0	0	0	0							

FICHE D'INCIDENT N°19/003

Date de l'incident : 10/06/2019

Date d'ouverture de la fiche : 11/06/2019

Destinataire :

- DRIEE Mail : mary-anne.mathieu@developpement-durable.gouv.fr
 Préfecture Fax 01 49 56 64 08..... (Tél 01 49 56 60 00)
 SMITDUVM Mail : kiken@gpsea.fr et amvinois@gpsea
 Autres Fax Tél.....

Secteur de l'usine touché :

Heure : à

EMERAUDE

- Hall de déchargement
 Fosse
 Fours/chaudières
 Traitement fumées / effluent
 Bâtiment administratif
 Tours aéroréfrigérantes

DAS

- Hall de déchargement
 Bâtiment administratif
 Manutention
 Four /Chaudières
 Traitement fumés / effluent
 Tour aéroréfrigérante

AUTRE

- Rejet liquide usine
 Voies de circulation
 Environnement usine

Evaluation de la situation :

- Problème d'incendie
 Problème d'analyseur
 Problème de pollution
 Dégagement de fumées
 Dépassement de seuils polluants
 Dépassement du seuil en légionelles de 100 000 UFC/l
 Pollution accidentelle au niveau du stockage des produits
 Huile Fioul Autres :
- Impact sonore
 Impact visuel

Etat de la situation :

- Maîtrisé Non maîtrisé En cours de traitement
 PIOS déclenché Dégât matériel : Victime /état :

Origine du problème rencontré :

Dépassement du seuil haut de la moyenne jour du pH au rejet Nord à pH = 8,53 (pour un seuil haut à 8,5).

Non identifiée

Identifiée : Suite au redémarrage du traitement des effluents après arrêt technique Emeraude, il y a eu un dysfonctionnement de la pompe d'injection de HCl en remise à pH.

Moyens déjà engagés : Intervention sur la commande de la pompe d'injection d'HCl.

Moyens complémentaires à demander : /

Pièces jointes : Rapports journalier du 10/06/2019

Nom, fonction et signature du déclarant :

Marie-Christine VIRATELLE, Directrice de Site



VALO'MARNE

10/11, rue des Malfourches
94034 CRETEIL Cedex
Tél. : 01.48.98.55.11
Fax : 01.48.98.48.83
SIRET : 833 921 232 00017



Rapport Rejet AQ Jour

Rapport journalier													10 Juin 2019										
Région Eggen																							
Debit	Pe	Maximale (6)	Température	Mixage	Température	Temp.	Température	Température	Temp.	Temp.	Temp.	Temp.	Temp.	Temp.	Temp.	Temp.	Temp.	Temp.	Temp.	Temp.	Temp.		
(m³)	(%)	(m³/s)	(°C)	(m³/s)	(°C)	(m³/s)	(°C)	(m³/s)	(°C)	(m³/s)	(°C)	(m³/s)	(°C)	(m³/s)	(°C)	(m³/s)	(°C)	(m³/s)	(°C)	(m³/s)	(°C)		
01:00	0.12	6.50	0.00	00:00:00	0.00	00:00:00	20.03	0.00	00:00:00	0.00	00:00:00	15.88	0.00	00:00:00	6.00	00:00:00	00:48:00	0.00	00:00:00	00:37:40	0.00	0.00	8.96
02:00	0.12	6.56	0.00	00:00:00	0.00	00:00:00	19.86	0.00	00:00:00	0.00	00:00:00	15.88	0.00	00:00:00	5.93	00:00:00	00:39:10	0.00	00:00:00	01:00:00	10.00	0.00	5.39
03:00	9.03	6.74	0.00	00:00:00	0.00	00:00:00	22.22	0.00	00:00:00	0.00	00:00:00	12.11	0.00	00:00:00	11.82	00:00:00	01:00:00	0.00	00:00:00	01:00:00	5.23	0.00	4.91
04:00	9.96	6.96	0.00	00:00:00	0.00	00:00:00	25.95	0.00	00:00:00	0.00	00:00:00	12.86	0.00	00:00:00	25.05	00:00:00	01:00:00	0.00	00:00:00	01:00:00	4.80	0.00	5.86
05:00	5.17	6.97	0.00	00:00:00	0.00	00:00:00	26.14	0.00	00:00:00	0.00	00:00:00	12.86	0.00	00:00:00	27.81	00:00:00	01:00:00	0.00	00:00:00	01:00:00	7.76	0.00	7.82
06:00	5.11	7.15	0.00	00:00:00	0.00	00:00:00	26.06	0.00	00:00:00	0.00	00:00:00	12.86	0.00	00:00:00	21.44	00:00:00	01:00:00	0.00	00:00:00	01:00:00	7.39	0.00	8.83
07:00	5.00	7.14	0.00	00:00:00	0.00	00:00:00	26.14	0.00	00:00:00	0.00	00:00:00	12.86	0.00	00:00:00	12.74	00:00:00	01:00:00	0.00	00:00:00	01:00:00	9.31	0.00	8.02
08:00	4.86	7.05	0.00	00:00:00	0.00	00:00:00	26.30	0.00	00:00:00	0.00	00:00:00	12.86	0.00	00:00:00	10.04	00:00:00	01:00:00	0.00	00:00:00	01:00:00	8.40	0.00	7.97
09:00	5.80	6.90	0.00	00:00:00	0.00	00:00:00	27.00	0.02	00:00:10	0.00	00:00:00	12.42	0.00	00:00:00	7.76	00:00:00	01:00:00	0.00	00:00:00	01:00:00	9.13	0.00	6.33
10:00	7.92	9.38	0.00	00:00:00	0.00	00:43:28	27.29	2.01	00:15:50	0.00	00:00:00	12.60	0.00	00:00:00	7.50	00:00:00	01:00:00	0.00	00:00:00	01:00:00	5.40	0.00	5.41
11:00	7.88	10.40	0.00	00:00:00	0.00	01:00:00	24.11	0.00	00:00:00	0.00	00:00:00	15.44	0.00	00:00:00	7.80	00:00:00	01:00:00	0.00	00:00:00	01:00:00	9.95	0.00	10.20
12:00	7.36	10.24	0.00	00:00:00	0.00	01:00:00	24.24	0.00	00:00:00	0.00	00:00:00	17.53	0.00	00:00:00	7.80	00:00:00	01:00:00	0.00	00:00:00	01:00:00	6.06	0.00	6.06
13:00	8.83	10.61	0.00	00:00:00	0.00	01:00:00	23.43	0.00	00:00:00	0.00	00:00:00	22.82	0.00	00:00:00	7.60	00:00:00	01:00:00	0.00	00:00:00	01:00:00	7.80	0.00	7.80
14:00	7.84	10.19	0.00	00:00:00	0.00	01:00:00	24.22	0.00	00:00:00	0.00	00:00:00	25.46	0.00	00:00:00	7.30	00:00:00	01:00:00	0.00	00:00:00	01:00:00	8.02	0.00	8.02
15:00	9.27	10.76	0.00	00:00:00	0.00	01:00:00	22.95	0.00	00:00:00	0.00	00:00:00	29.20	0.00	00:00:00	7.20	00:00:00	01:00:00	0.00	00:00:00	01:00:00	9.31	0.00	9.31
16:00	8.06	10.44	0.00	00:00:00	0.00	01:00:00	23.86	0.00	00:00:00	0.00	00:00:00	27.53	0.00	00:00:00	7.20	00:00:00	01:00:00	0.00	00:00:00	01:00:00	8.02	0.00	8.02
17:00	8.20	10.42	0.00	00:00:00	0.00	01:00:00	23.96	0.00	00:00:00	0.00	00:00:00	31.09	0.00	00:00:00	7.12	00:00:00	01:00:00	0.00	00:00:00	01:00:00	8.40	0.00	8.40
18:00	8.03	10.34	0.00	00:00:00	0.00	01:00:00	24.21	0.00	00:00:00	0.00	00:00:00	34.83	0.00	00:00:00	6.57	00:00:00	01:00:00	0.00	00:00:00	01:00:00	7.97	0.00	7.97
19:00	9.15	10.17	0.00	00:00:00	0.00	01:00:00	23.71	0.00	00:00:00	0.00	00:00:00	36.04	0.00	00:00:00	6.14	00:00:00	01:00:00	0.00	00:00:00	01:00:00	9.13	0.00	9.13
20:00	6.29	8.47	0.00	00:00:00	0.00	00:24:00	25.36	0.00	00:00:00	0.00	00:00:00	27.17	0.00	00:00:00	5.10	00:00:00	01:00:00	0.00	00:00:00	01:00:00	6.33	0.00	6.33
21:00	6.06	8.06	0.00	00:00:00	0.00	00:00:00	26.12	0.00	00:00:00	0.00	00:00:00	26.25	0.00	00:00:00	4.53	00:00:00	01:00:00	0.00	00:00:00	01:00:00	6.06	0.00	6.06
22:00	5.42	7.84	0.00	00:00:00	0.00	00:00:00	26.73	0.00	00:00:00	0.00	00:00:00	26.25	0.00	00:00:00	4.13	00:00:00	01:00:00	0.00	00:00:00	01:00:00	5.40	0.00	5.40
23:00	5.29	7.68	0.00	00:00:00	0.00	00:00:00	26.84	0.00	00:00:00	0.00	00:00:00	26.25	0.00	00:00:00	4.12	00:00:00	01:00:00	0.00	00:00:00	01:00:00	5.41	0.00	5.41
00:00	9.93	7.76	0.00	00:00:00	0.00	00:00:00	21.67	0.00	00:00:00	0.00	00:00:00	29.43	0.00	00:00:00	3.80	00:00:00	01:00:00	0.00	00:00:00	01:00:00	9.95	0.00	9.95
Max	9.96	10.76	0.00		0.00		27.29	2.01		0.00		34.83	0.00		7.80					21:38:50	10.20	0.00	10.20
Min	0.12	6.50	0.00		0.00		19.86	0.00		0.00		12.42	0.00		4.53						6.06	0.00	6.06
Moy. Global	6.74	8.23	0.00		0.00		24.22	0.00		0.00		23.43	0.00		6.57						7.50	0.00	7.50
Temp. Global	6.96	8.47	0.00		0.00		25.36	0.00		0.00		27.17	0.00		5.10						6.14	0.00	6.14
Temp. Global	5.17	7.15	0.00		0.00		26.14	0.00		0.00		26.25	0.00		4.53						4.13	0.00	4.13
Temp. Global	5.11	7.14	0.00		0.00		26.06	0.00		0.00		26.25	0.00		4.12						4.12	0.00	4.12
Temp. Global	4.86	7.05	0.00		0.00		26.30	0.00		0.00		26.25	0.00		4.13						4.12	0.00	4.12
Temp. Global	5.80	6.90	0.00		0.00		27.00	0.02		0.00		26.25	0.00		4.12						4.12	0.00	4.12
Temp. Global	7.92	9.38	0.00		0.00		27.29	2.01		0.00		29.43	0.00		3.80						3.80	0.00	3.80
Temp. Global	7.88	10.40	0.00		0.00		24.11	0.00		0.00		15.44	0.00		7.76						7.76	0.00	7.76
Temp. Global	7.36	10.24	0.00		0.00		24.24	0.00		0.00		17.53	0.00		7.80						7.80	0.00	7.80
Temp. Global	8.83	10.61	0.00		0.00		23.43	0.00		0.00		22.82	0.00		7.60						7.60	0.00	7.60
Temp. Global	7.84	10.19	0.00		0.00		24.22	0.00		0.00		25.46	0.00		7.30						7.30	0.00	7.30
Temp. Global	9.27	10.76	0.00		0.00		22.95	0.00		0.00		29.20	0.00		7.50						7.50	0.00	7.50
Temp. Global	8.06	10.44	0.00		0.00		23.86	0.00		0.00		27.53	0.00		7.20						7.20	0.00	7.20
Temp. Global	8.20	10.42	0.00		0.00		23.96	0.00		0.00		31.09	0.00		7.12						7.12	0.00	7.12
Temp. Global	8.03	10.34	0.00		0.00		24.21	0.00		0.00		34.83	0.00		6.57						6.57	0.00	6.57
Temp. Global	9.15	10.17	0.00		0.00		23.71	0.00		0.00		36.04	0.00		6.14						6.14	0.00	6.14
Temp. Global	6.29	8.47	0.00		0.00		25.36	0.00		0.00		27.17	0.00		5.10						5.10	0.00	5.10
Temp. Global	6.06	8.06	0.00		0.00		26.12	0.00		0.00		26.25	0.00		4.53						4.53	0.00	4.53
Temp. Global	5.42	7.84	0.00		0.00		26.73	0.00		0.00		26.25	0.00		4.13						4.13	0.00	4.13
Temp. Global	5.29	7.68	0.00		0.00		26.84	0.00		0.00		26.25	0.00		4.12						4.12	0.00	4.12
Temp. Global	9.93	7.76	0.00		0.00		21.67	0.00		0.00		29.43	0.00		3.80						3.80	0.00	3.80
Temp. Global	9.96	10.76	0.00		0.00		27.29	2.01		0.00		34.83	0.00		7.80						7.80	0.00	7.80
Temp. Global	6.12	8.50	0.00																				

FICHE D'INCIDENT N°19/004

Date de l'incident : 15/06/2019

Date d'ouverture de la fiche : 17/06/2019

Destinataire :

DRIEE Mail : mary-anne.mathieu@developpement-durable.gouv.fr
 Préfecture Fax 01 49 56 64 08..... (Tél 01 49 56 60 00)
 SMITDUVM Mail : kikenl@gpsea.fr et amvinois@gpsea
 Autres Fax Tél.....

Secteur de l'usine touché :

Heure : à

EMERAUDE

- Hall de déchargement
- Fosse
- Fours/chaudières
- Traitement fumées / effluent
- Bâtiment administratif
- Tours aéroréfrigérantes

DAS

- Hall de déchargement
- Bâtiment administratif
- Manutention
- Four /Chaudières
- Traitement fumés / effluent
- Tour aéroréfrigérante

AUTRE

- Rejet liquide usine
- Voies de circulation
- Environnement usine

Evaluation de la situation :

- Problème d'incendie
- Problème d'analyseur
- Problème de pollution
 - Dégagement de fumées
 - Dépassement de seuils polluants
 - Dépassement du seuil en légionelles de 100 000 UFC/l
 - Pollution accidentelle au niveau du stockage des produits
 - Huile Fioul Autres :
- Impact sonore
- Impact visuel

Etat de la situation :

- Maîtrisé Non maîtrisé En cours de traitement
- PIOS déclenché Dégât matériel : Victime /état :

Origine du problème rencontré :

Dépassement de la valeur moyenne jour en NOx sur la ligne DAS à 101,14 mg/Nm3 (pour un seuil à 100 mg/Nm3).

Non identifiée

Identifiée : Suite à une cadence soutenue sur le four DASRI, une température trop importante en post combustion a provoqué des mesures hautes en NOx..

Moyens déjà engagés : Baisse de la température en diminuant la consigne d'enfournement.

Moyens complémentaires à demander : /

Pièces jointes : Rapports journalier du 15/06/2019

Nom, fonction et signature du déclarant :

Marie-Christine VIRATELLE, Directrice de Site



VALO'MARNE

10/11, rue des Malfourches
94034 CRETEIL Cedex
Tél. : 01.48.98.55.11
Fax : 01.48.98.48.83
SIRET : 833 921 232 0017

Rapport DREAL Journalier Ligne 4

Moyen (C95) Ligne 4																	
Unité	CO	COT	HCL	NH3	NOX	POUSSIERE	SO2	Vitesse30	T4	T20	O2	T19_20_L4	Moyenne	Poussier	L4_30	Ibanage	DASRI
mg/Nm3	mg/Nm3	mg/Nm3	mg/Nm3	mg/Nm3	mg/Nm3	mg/Nm3	mg/Nm3	m/s	°C	°C	%	°C	µm/m3	µm/m3	Tonne	Tonne	Tonne
VLE 1/2h	100	100	20	60	20	30	200				13						
VLE max	100	100	20	60	20	150	200										
Seuil Min.	50	50	10	10	10	100	10	50									
VLE Jour	50	50	10	10	10	100	10	50									
00:30	4.59	0.00	4.52	0.52	49.40	1.179	8.13	16.11	11.87	978.5	00:30:00	0.0					
01:00	1.16	0.00	8.98	0.46	87.73	1.148	12.93	17.66	11.70	1006.4	00:30:00	0.0					
01:30	0.14	0.00	6.45	0.40	422.77	1.244	13.15	21.73	12.17	1037.1	00:30:00	0.0					
02:00	1.50	0.00	5.32	0.38	89.01	1.223	8.40	19.76	12.12	1019.4	00:30:00	0.0					
02:30	1.15	0.00	6.04	0.43	79.98	1.224	8.24	20.49	12.22	1009.1	00:30:00	0.0					
03:00	1.82	0.00	6.37	0.40	73.60	1.223	7.14	19.71	12.02	1016.7	00:30:00	0.0					
03:30	1.13	0.00	8.01	0.42	90.82	2.179	7.38	20.33	12.04	1027.6	00:30:00	0.0					
04:00	0.54	0.00	5.92	0.40	109.01	1.262	8.97	20.74	12.04	1015.0	00:30:00	0.0					
04:30	1.14	0.00	5.76	0.42	80.69	1.200	7.91	20.12	12.31	1027.5	00:30:00	0.0					
05:00	0.42	0.00	5.74	0.43	128.08	1.292	7.05	24.12	12.32	1029.1	00:30:00	0.0					
05:30	0.24	0.00	5.42	0.41	133.28	1.270	7.73	23.11	12.32	1030.8	00:30:00	0.0					
06:00	0.38	0.00	6.56	0.38	122.79	1.251	8.35	23.06	12.32	1027.7	00:30:00	0.0					
06:30	1.02	0.00	7.38	0.14	113.27	1.291	5.99	23.72	12.36	1049.3	00:30:00	0.0					
07:00	0.33	0.00	8.23	0.21	162.22	1.288	6.44	22.85	12.45	1030.8	00:30:00	0.0					
07:30	0.30	0.00	7.85	0.24	122.12	1.291	6.99	22.81	12.33	1029.8	00:30:00	0.0					
08:00	0.47	0.00	7.06	0.20	123.68	1.254	5.55	24.15	12.49	1033.3	00:30:00	0.0					
08:30	0.47	0.00	7.61	0.25	132.72	1.307	6.12	24.15	12.49	1040.7	00:30:00	0.0					
09:00	0.29	0.00	8.85	0.19	145.84	1.288	7.28	24.87	12.32	1028.8	00:30:00	0.0					
09:30	0.37	0.01	8.45	0.18	129.95	1.320	6.18	24.35	12.36	1040.7	00:30:00	0.0					
10:00	0.27	0.01	5.17	0.28	116.26	1.302	4.37	25.13	12.34	1020.7	00:30:00	0.0					
10:30	0.22	0.01	6.95	0.37	160.77	1.301	4.35	26.38	11.96	1047.0	00:30:00	0.0					
11:00	0.13	0.00	14.69	0.21	137.17	1.296	5.63	24.05	12.30	1030.6	00:30:00	0.0					
11:30	0.43	0.00	17.49	0.24	104.78	1.274	6.20	21.33	12.36	1014.8	00:30:00	0.0					
12:00	1.07	0.00	17.33	0.32	74.64	1.261	4.35	23.15	12.23	999.3	00:30:00	0.0					
12:30	2.37	0.00	11.31	0.36	70.70	1.238	4.09	22.59	12.21	996.9	00:30:00	0.0					
13:00	2.16	0.00	11.09	0.42	88.43	1.309	2.99	23.07	12.27	1003.6	00:30:00	0.0					
13:30	0.67	0.00	7.86	0.36	152.23	1.250	2.67	25.17	11.99	1036.6	00:30:00	0.0					
14:00	0.02	0.00	5.23	0.39	190.88	1.227	2.70	24.15	12.05	1059.0	00:30:00	0.0					
14:30	Arrêt	Arrêt	Arrêt	Arrêt	Arrêt	Arrêt	Arrêt	Arrêt	Arrêt	Arrêt	00:15:00	0.0					
15:00	0.67	0.00	6.68	0.28	103.24	1.197	5.79	18.21	12.05	1023.8	00:30:00	0.0					
15:30	12.49	0.09	6.23	0.38	118.78	1.196	4.12	20.27	12.03	1015.7	00:30:00	0.0					
16:00	0.67	0.00	6.68	0.28	103.24	1.197	5.79	18.21	12.05	1023.8	00:30:00	0.0					
16:30	1.23	0.00	9.20	0.21	85.28	1.129	8.19	16.15	11.81	1010.7	00:30:00	0.0					
17:00	0.51	0.00	10.09	0.18	100.80	1.191	6.70	17.19	11.66	1019.9	00:30:00	0.0					
17:30	1.28	0.00	12.29	0.19	64.91	1.143	9.11	15.36	11.81	993.1	00:30:00	0.0					
18:00	3.41	0.00	14.24	0.18	32.10	1.201	7.38	14.32	12.62	992.3	00:30:00	0.0					
18:30	1.24	0.00	9.06	0.21	64.34	1.231	5.59	17.74	12.29	969.9	00:30:00	0.0					
19:00	0.76	0.00	5.83	0.20	94.78	1.189	6.49	21.85	11.93	1017.2	00:30:00	0.0					
19:30	Arrêt	Arrêt	Arrêt	Arrêt	Arrêt	Arrêt	Arrêt	Arrêt	Arrêt	Arrêt	00:15:00	0.0					
20:00	1.85	0.00	10.71	0.13	102.92	1.058	13.71	15.43	10.80	1028.3	00:30:00	0.0					
20:30	0.78	0.00	6.76	0.13	119.46	1.124	11.72	17.65	11.34	1003.7	00:30:00	0.0					
21:00	27.93	1.37	6.99	0.12	75.84	1.133	12.33	15.10	11.31	1017.8	00:30:00	0.0					
21:30	1.38	0.00	11.15	0.07	62.03	0.904	11.73	10.40	9.30	995.3	00:30:00	0.0					
22:00	2.27	0.00	13.88	0.10	80.34	0.930	8.49	13.98	9.59	1013.3	00:30:00	0.0					
22:30	16.02	0.10	10.56	0.13	85.13	1.250	11.38	18.38	12.47	1009.7	00:30:00	0.0					
23:00	77.66	1.64	5.93	0.30	24.18	1.280	6.23	15.54	12.17	944.1	00:30:00	0.0					
23:30	23.74	0.35	3.10	0.46	45.10	1.065	3.56	13.38	10.89	994.1	00:30:00	0.0					
00:00	0.73	0.00	3.62	0.36	78.61	1.145	6.76	17.31	11.69	1015.2	00:30:00	0.0					
Max.	77.66	1.64	17.49	0.36	190.88	1.179	13.71	26.38	12.62	1059.0		0.0					
Min.	0.03	0.00	4.52	0.07	24.18	0.904	2.67	10.40	9.30	944.1		0.0					
Moy/Comet	4.44	0.08	8.34	0.30	101.14	1.234	7.29	20.17	11.98	1016.2	23:31:59	0.0					
Dép. VLE 1/2h	0	0	0	0	0	0	0	0	0	0	0	0					
Dép. VLE max	00:00	00:00	0	0	0	00:00	0	0	0	0	0	0					
Dép. Seuil Min.	0	0	0	0	0	0	0	00:30	0	00:00	0	0					
Indisponibilité	0	0	0	0	0	0	0	0	0	0	0	0					
% données HC	0.00	0.00	0.00	0.00	0.00	0.00	0.00	0.00	0.00	0.00	0.00	0.00					
Invalide	0	0	0	0	0	0	0	0	0	0	0	0					
Dép. VLE Jour	0	0	0	0	0	0	0	0	0	0	0	0					

Indicateur	05:00	09:30	05:00	05:00	05:00	05:00	05:00	05:00
Dépassement >4H	0	0	0	0	0	0	0	0
Dép. VLE	00:00	13:30	00:00	00:00	00:00	00:30	00:00	14:00
Nb jour invalides	1	1	1	1	1	1	1	1
Indis. Cons >10h	0	0	0	0	0	0	0	0
Indisponibilité	05:00	09:30	05:00	05:00	05:00	05:00	05:00	09:30

FICHE D'INCIDENT N°19/005

Date de l'incident : 28/06/2019

Date d'ouverture de la fiche : 01/07/2019

Destinataire :

DRIE Mail : mary-anne.mathieu@developpement-durable.gouv.fr
 Préfecture Fax 01 49 56 64 08..... (Tél 01 49 56 60 00)
 SMITDUM Mail : kiken@gpsea.fr et amvinois@gpsea
 Autres Fax Tél.....

Secteur de l'usine touché :

Heure : à

EMERAUDE

- Hall de déchargement
- Fosse
- Fours/chaudières
- Traitement fumées / effluent
- Bâtiment administratif
- Tours aéroréfrigérantes

DAS

- Hall de déchargement
- Bâtiment administratif
- Manutention
- Four /Chaudières
- Traitement fumés / effluent
- Tour aéroréfrigérante

AUTRE

- Rejet liquide usine
- Voies de circulation
- Environnement usine

Evaluation de la situation :

- Problème d'incendie
- Problème d'analyseur
- Problème de pollution
 - Dégagement de fumées
 - Dépassement de seuils polluants
 - Dépassement du seuil en légionelles de 100 000 UFC/l
 - Pollution accidentelle au niveau du stockage des produits
 - Huile Fioul Autres :
- Impact sonore
- Impact visuel

Etat de la situation :

- Maîtrisé Non maîtrisé En cours de traitement
- PIOS déclenché Dégât matériel : Victime /état :

Origine du problème rencontré :

La moyenne journalière de température des rejets liquides a atteint 30,45 °C (pour un seuil à 30 °C).

Cause :

- Non identifiée
- Identifiée : La température ambiante est élevée en cette période estivale et caniculaire.

Moyens déjà engagés :

- Contrôle des températures de l'ensemble des effluents du site.
- Nettoyage de l'échangeur à plaques pour le refroidissement des effluents d'EMERAUDE.

Moyens complémentaires à demander : /

Pièces jointes : Rapports journalier du 28/06/2019

Nom, fonction et signature du déclarant :

Marie-Christine VIRATELLE, Directrice de Site



VALO'MARNE
10/11, rue des Malfourches
94034 CRETEIL Cedex
Tél. : 01.48.98.55.11
Fax : 01.48.98.48.83
SIRET : 833 921 232 00017



Rapport Rejet AQ Jour

28 Jun 2019

Rapport journalier

Emission journalière		Vitesse F1 (m/s)			Température ambiante (°C)			Vitesse vent (m/s)			Vitesse vent (m/s)			Vitesse vent (m/s)				
Dir.	Val.	Dir.	Val.	Dir.	Val.	Dir.	Val.	Dir.	Val.	Dir.	Val.	Dir.	Val.	Dir.	Val.			
01:00	9.44	7.08	0.00	00:00:00	0.00	00:00:00	0.00	00:53:00	8.62	00:53:00	28.31	6.00	00:00:00	4.64	0.00	00:00:00	01:00:00	9.52
02:00	11.96	7.15	0.00	00:00:00	0.00	00:00:00	0.00	01:00:00	11.89	01:00:00	12.69	0.00	00:00:00	4.69	0.00	00:00:00	01:00:00	11.89
03:00	11.79	7.25	0.00	00:00:00	0.00	00:00:00	0.00	00:37:50	7.06	00:37:50	11.36	0.00	00:00:00	4.03	0.00	00:00:00	01:00:00	11.64
04:00	10.87	7.23	0.00	00:00:00	0.00	00:00:00	0.00	00:42:40	7.27	00:42:40	11.54	0.00	00:00:00	3.94	0.00	00:00:00	01:00:00	10.89
05:00	12.09	7.20	0.00	00:00:00	0.00	00:00:00	0.00	00:04:00	0.78	00:04:00	12.55	0.00	00:00:00	3.93	0.00	00:00:00	01:00:00	12.12
06:00	11.98	7.12	0.00	00:00:00	0.00	00:00:00	0.00	00:42:10	8.40	00:42:10	12.39	0.00	00:00:00	3.90	0.00	00:00:00	01:00:00	12.11
07:00	10.11	7.05	0.00	00:00:00	0.00	00:00:00	0.00	00:24:20	3.20	00:24:20	11.64	0.00	00:00:00	3.76	0.00	00:00:00	01:00:00	10.11
08:00	8.49	7.02	0.00	00:00:00	0.00	00:00:00	0.00	00:41:50	5.10	00:41:50	11.36	0.00	00:00:00	3.35	0.00	00:00:00	01:00:00	8.46
09:00	8.79	7.08	0.00	00:00:00	0.00	00:00:00	0.00	00:32:20	4.02	00:32:20	11.16	0.00	00:00:00	4.17	0.00	00:00:00	01:00:00	8.79
10:00	7.95	6.99	0.00	00:00:00	0.00	00:00:00	0.00	00:42:20	4.99	00:42:20	11.87	0.00	00:00:00	2.51	0.00	00:00:00	01:00:00	7.97
11:00	8.38	7.00	0.00	00:00:00	0.00	00:00:00	0.00	00:35:50	4.29	00:35:50	12.15	0.00	00:00:00	4.34	0.00	00:00:00	01:00:00	8.36
12:00	10.69	6.91	0.00	00:00:00	0.00	00:00:00	0.00	00:00:00	0.00	00:00:00	11.28	0.00	00:00:00	6.04	0.00	00:00:00	01:00:00	10.69
13:00	6.62	7.45	0.00	00:00:00	0.00	00:00:00	0.00	00:36:10	3.46	00:36:10	10.49	0.00	00:00:00	3.84	0.00	00:00:00	01:00:00	6.56
14:00	7.42	7.27	0.00	00:00:00	0.00	00:00:00	0.00	00:44:40	4.60	00:44:40	9.85	0.00	00:00:00	3.50	0.00	00:00:00	01:00:00	7.39
15:00	8.18	6.97	0.00	00:00:00	0.00	00:00:00	0.00	00:43:28	5.03	00:43:28	9.59	0.00	00:00:00	3.79	0.00	00:00:00	01:00:00	8.18
16:00	6.72	7.12	0.00	00:00:00	0.00	00:00:00	0.00	01:00:20	6.69	01:00:20	9.28	0.00	00:00:00	3.37	0.00	00:00:00	01:00:00	6.69
17:00	8.23	7.42	0.00	00:00:00	0.00	00:00:00	0.00	00:39:20	4.34	00:39:20	9.37	0.00	00:00:00	2.76	0.00	00:00:00	01:00:00	8.20
18:00	11.85	7.48	0.00	00:00:00	0.00	00:00:00	0.00	00:43:00	8.42	00:43:00	11.77	0.00	00:00:00	3.43	0.00	00:00:00	01:00:00	11.84
19:00	11.80	7.15	0.00	00:00:00	0.00	00:00:00	0.00	01:00:00	11.81	01:00:00	12.14	0.00	00:00:00	4.42	0.00	00:00:00	01:00:00	11.81
20:00	11.61	7.15	0.00	00:00:00	0.00	00:00:00	0.00	01:00:00	11.50	01:00:00	12.40	0.00	00:00:00	4.50	0.00	00:00:00	01:00:00	11.50
21:00	11.42	7.23	0.00	00:00:00	0.00	00:00:00	0.00	01:00:00	11.43	01:00:00	12.52	0.00	00:00:00	4.51	0.00	00:00:00	01:00:00	11.43
22:00	11.08	7.21	0.00	00:00:00	0.00	00:00:00	0.00	01:00:00	11.06	01:00:00	12.90	0.00	00:00:00	4.56	0.00	00:00:00	01:00:00	11.06
23:00	10.84	7.15	0.00	00:00:00	0.00	00:00:00	0.00	01:00:00	10.80	01:00:00	13.08	0.00	00:00:00	4.41	0.00	00:00:00	01:00:00	10.80
00:00	10.80	7.09	0.00	00:00:00	0.00	00:00:00	0.00	01:00:00	10.81	01:00:00	12.94	0.00	00:00:00	4.34	0.00	00:00:00	01:00:00	10.81

FICHE D'INCIDENT N°19/006

Date de l'incident : 29/06/2019

Date d'ouverture de la fiche : 01/07/2019

Destinataire :

DRIEE Mail : mary-anne.mathieu@developpement-durable.gouv.fr
 Préfecture Fax 01 49 56 64 08..... (Tél 01 49 56 60 00)
 SMITDUVM Mail : kiken@gpsea.fr et amvinois@gpsea
 Autres Fax Tél.....

Secteur de l'usine touché :

Heure : à

EMERAUDE

- Hall de déchargement
- Fosse
- Fours/chaudières
- Traitement fumées / effluent
- Bâtiment administratif
- Tours aéroréfrigérantes

DAS

- Hall de déchargement
- Bâtiment administratif
- Manutention
- Four /Chaudières
- Traitement fumés / effluent
- Tour aéroréfrigérante

AUTRE

- Rejet liquide usine
- Voies de circulation
- Environnement usine

Evaluation de la situation :

- Problème d'incendie
- Problème d'analyseur
- Problème de pollution
 - Dégagement de fumées
 - Dépassement de seuils polluants
 - Dépassement du seuil en légionelles de 100 000 UFC/l
 - Pollution accidentelle au niveau du stockage des produits
 - Huile Fioul Autres :
- Impact sonore
- Impact visuel

Etat de la situation :

- Maîtrisé Non maîtrisé En cours de traitement
- PIOS déclenché Dégât matériel : Victime /état :

Origine du problème rencontré :

La moyenne journalière de température des rejets liquides a atteint 31,27 °C (pour un seuil à 30 °C).

Cause :

- Non identifiée
- Identifiée : La température ambiante est élevée en cette période estivale et caniculaire.

Moyens déjà engagés :

- Contrôle des températures de l'ensemble des effluents du site.
- Nettoyage de l'échangeur à plaques pour le refroidissement des effluents d'EMERAUDE.

Moyens complémentaires à demander : /

Pièces jointes : Rapports journalier du 29/06/2019

Nom, fonction et signature du déclarant :

Marie-Christine VIRATELLE, Directrice de Site



VALO'MARNE

10/11, rue des Malfourches
94034 CRETEIL Cedex
Tél. : 01.48.98.55.11
Fax : 01.48.98.48.83
SIRET : 833 921 232 00017

FICHE D'INCIDENT N°19/007

Date de l'incident : 30/06/2019

Date d'ouverture de la fiche : 01/07/2019

Destinataire :

DRIEE Mail : mary-anne.mathieu@developpement-durable.gouv.fr
 Préfecture Fax 01 49 56 64 08..... (Tél 01 49 56 60 00)
 SMITDUVM Mail : kiken@gpsea.fr et amvinois@gpsea
 Autres Fax..... Tél.....

Secteur de l'usine touché :

Heure : à.....

EMERAUDE

- Hall de déchargement
- Fosse
- Fours/chaudières
- Traitement fumées / effluent
- Bâtiment administratif
- Tours aéroréfrigérantes

DAS

- Hall de déchargement
- Bâtiment administratif
- Manutention
- Four /Chaudières
- Traitement fumés / effluent
- Tour aéroréfrigérante

AUTRE

- Rejet liquide usine
- Voies de circulation
- Environnement usine

Evaluation de la situation :

- Problème d'incendie
- Problème d'analyseur
- Problème de pollution
 - Dégagement de fumées
 - Dépassement de seuils polluants
 - Dépassement du seuil en légionelles de 100 000 UFC/l
 - Pollution accidentelle au niveau du stockage des produits
 - Huile Fioul Autres :
- Impact sonore
- Impact visuel

Etat de la situation :

- Maîtrisé Non maîtrisé En cours de traitement
- PIOS déclenché Dégât matériel : Victime /état :

Origine du problème rencontré :

La moyenne journalière de température des rejets liquides a atteint 31,27 °C (pour un seuil à 30 °C).

Cause :

- Non identifiée
- Identifiée : La température ambiante est élevée en cette période estivale et caniculaire.

Moyens déjà engagés :

- Contrôle des températures de l'ensemble des effluents du site.
- Nettoyage de l'échangeur à plaques pour le refroidissement des effluents d'EMERAUDE.

Moyens complémentaires à demander : /

Pièces jointes : Rapports journalier du 30/06/2019

Nom, fonction et signature du déclarant :

Marie-Christine VIRATELLE, Directrice de Site



VALO'MARNE
10/11, rue des Malfourches
94034 CRETEIL Cedex
Tél. : 01.48.98.55.11
Fax : 01.48.98.48.83
SIRET : 833 921 232 00017

Rapport Rejet AQ Jour

30 Jun 2019

Heure	PM	Volume PM	Temp PM	Humid PM	Volume PM	Temp PM	Humid PM	Volume PM	Temp PM	Humid PM	Volume PM	Temp PM	Humid PM	Volume PM	Temp PM	Humid PM	Volume PM	Temp PM	Humid PM	Volume PM	Temp PM	Humid PM	Volume PM	Temp PM	Humid PM
01:00	6.38	7.08	0.00	00:00:00	0.00	00:00:00	6.42	01:00:00	10.42	0.00	00:00:00	3.33	0.00	00:00:00	01:00:00	6.42									
02:00	4.65	7.42	0.00	00:00:00	0.00	00:00:00	4.59	01:00:00	7.59	0.00	00:00:00	2.30	0.00	00:00:00	01:00:00	4.59									
03:00	5.00	7.91	0.00	00:00:00	0.00	00:00:00	4.97	01:00:00	10.91	0.00	00:00:00	1.82	0.00	00:00:00	01:00:00	4.97									
04:00	4.97	7.33	0.00	00:00:00	0.00	00:00:00	4.94	01:00:00	10.21	0.00	00:00:00	2.31	0.00	00:00:00	01:00:00	4.98									
05:00	5.97	6.92	0.00	00:00:00	0.00	00:00:00	5.99	01:00:00	11.15	0.00	00:00:00	2.08	0.00	00:00:00	01:00:00	5.99									
06:00	6.17	6.91	0.00	00:00:00	0.00	00:00:00	6.17	01:00:00	11.05	0.00	00:00:00	2.17	0.00	00:00:00	01:00:00	6.17									
07:00	7.31	6.66	0.00	00:00:00	0.00	00:00:00	7.37	01:00:00	11.48	0.00	00:00:00	2.36	0.00	00:00:00	01:00:00	7.37									
08:00	7.58	6.80	0.00	00:00:00	0.00	00:00:00	7.61	01:00:00	11.80	0.00	00:00:00	2.58	0.00	00:00:00	01:00:00	7.61									
09:00	7.19	6.46	0.00	00:00:00	0.00	00:00:00	6.62	00:54:40	11.74	0.00	00:00:00	2.51	0.00	00:00:00	00:54:40	6.62									
10:00	8.28	6.67	0.00	00:00:00	0.00	00:00:00	8.28	01:00:00	12.34	0.00	00:00:00	2.03	0.00	00:00:00	01:00:00	8.28									
11:00	8.78	6.90	0.00	00:00:00	0.00	00:00:00	8.88	00:48:50	13.25	0.00	00:00:00	2.43	0.00	00:00:00	01:00:00	8.76									
12:00	8.67	7.46	0.00	00:00:00	0.00	00:00:00	8.41	00:28:40	14.46	0.00	00:00:00	2.60	0.00	00:00:00	01:00:00	8.67									
13:00	9.52	7.37	0.00	00:00:00	0.00	00:00:00	9.52	00:17:50	14.94	0.00	00:00:00	3.19	0.00	00:00:00	01:00:00	9.50									
14:00	9.10	7.23	0.00	00:00:00	0.00	00:00:00	9.17	00:40:40	14.45	0.00	00:00:00	3.47	0.00	00:00:00	01:00:00	9.08									
15:00	7.86	7.08	0.00	00:00:00	0.00	00:00:00	8.03	00:52:30	13.41	0.00	00:00:00	3.19	0.00	00:00:00	01:00:00	7.87									
16:00	7.57	7.02	0.00	00:00:00	0.00	00:00:00	7.53	01:00:00	12.85	0.00	00:00:00	2.81	0.00	00:00:00	01:00:00	7.53									
17:00	7.64	6.98	0.00	00:00:00	0.00	00:00:00	7.66	01:00:00	12.99	0.00	00:00:00	2.70	0.00	00:00:00	01:00:00	7.66									
18:00	7.70	6.98	0.00	00:00:00	0.00	00:00:00	7.33	00:57:50	13.03	0.00	00:00:00	2.43	0.00	00:00:00	01:00:00	7.69									
19:00	8.12	6.81	0.00	00:00:00	0.00	00:00:00	8.12	01:00:00	13.33	0.00	00:00:00	2.41	0.00	00:00:00	01:00:00	8.12									
20:00	8.18	7.45	0.00	00:00:00	0.00	00:00:00	8.19	01:00:00	13.66	0.00	00:00:00	2.48	0.00	00:00:00	01:00:00	8.19									
21:00	7.63	7.63	0.00	00:00:00	0.00	00:00:00	7.40	00:58:30	14.27	0.00	00:00:00	2.18	0.00	00:00:00	01:00:00	7.66									
22:00	7.81	7.56	0.00	00:00:00	0.00	00:00:00	7.98	00:48:50	13.96	0.00	00:00:00	1.93	0.00	00:00:00	01:00:00	7.82									
23:00	8.49	7.49	0.00	00:00:00	0.00	00:00:00	8.45	00:35:30	14.28	0.00	00:00:00	2.11	0.00	00:00:00	00:50:00	7.10									
00:00	8.93	7.14	0.00	00:00:00	0.00	00:00:00	8.93	00:25:30	15.17	0.00	00:00:00	2.54	0.00	00:00:00	01:00:00	9.02									
Moy	8.33	7.91	0.00	00:00:00	0.00	00:00:00	8.33	00:00:00	13.13	0.00	00:00:00	2.47	0.00	00:00:00	00:00:00	8.33									
Min	4.65	6.46	0.00	00:00:00	0.00	00:00:00	4.59	00:00:00	7.59	0.00	00:00:00	1.82	0.00	00:00:00	00:00:00	4.59									
Max	9.52	7.37	0.00	00:00:00	0.00	00:00:00	9.52	00:00:00	14.94	0.00	00:00:00	3.19	0.00	00:00:00	00:00:00	9.50									
Dep. Sand Min																									
Dep. Sand Max																									
Intégration																									
Dep. Sand Jour																									

FICHE D'INCIDENT N°19/008

Date de l'incident : 06/07/2019

Date d'ouverture de la fiche : 08/07/2019

Destinataire :

DRIEE Mail : mary-anne.mathieu@developpement-durable.gouv.fr
 Préfecture Fax 01 49 56 64 08..... (Tél 01 49 56 60 00)
 SMITDUVM Mail : kikenl@gpsea.fr et amvinois@gpsea
 Autres Fax..... Tél.....

Secteur de l'usine touché :

Heure : à

EMERAUDE

- Hall de déchargement
- Fosse
- Fours/chaudières
- Traitement fumées / effluent
- Bâtiment administratif
- Tours aéroréfrigérantes

DAS

- Hall de déchargement
- Bâtiment administratif
- Manutention
- Four /Chaudières
- Traitement fumés / effluent
- Tour aéroréfrigérante

AUTRE

- Rejet liquide usine
- Voies de circulation
- Environnement usine

Evaluation de la situation :

- Problème d'incendie
- Problème d'analyseur
- Problème de pollution
 - Dégagement de fumées
 - Dépassement de seuils polluants
 - Dépassement du seuil en légionelles de 100 000 UFC/l
 - Pollution accidentelle au niveau du stockage des produits
 - Huile Fioul Autres :
- Impact sonore
- Impact visuel

Etat de la situation :

- Maîtrisé Non maîtrisé En cours de traitement
- PIOS déclenché Dégât matériel : Victime /état :

Origine du problème rencontré :

Dépassement de la valeur flux jour en NOx sur la ligne 2 à 153,759 Kg (pour un seuil à 153,6 Kg).

Cause :

- Non identifiée
- Identifiée : Consigne de régulation d'injection d'ammoniaque pour la captation des NOx à un niveau de marge insuffisante compte tenu du débit en cheminée sur une journée de combustion au nominal.

Moyens déjà engagés : Modification de la consigne de régulation (NOx : -10 mg/Nm3).

Moyens complémentaires à demander : /

Pièces jointes : Rapport journalier du 06/07/2019

Nom, fonction et signature du déclarant :

Marie-Christine VIRATELLE, Directrice de Site



Rapport DREAL Flux Journalier Ligne 2

Rapport Flux Journalier										06 Juillet 2019
FLUX Ligne 2										
Date	CO Kg	COT Kg	HCL Kg	NOx Kg	POUSSIERE Kg	SO2 Kg	NH3 Kg	MethaneFourL2 hh:mm:ss		
VLE Flux Jour	57.51	19.2	19.2	153.4	19.2	96	19.2			
00:30	0.311	0.034	0.104	2.736	0.422	0.921	0.000	00:30:00		
01:00	0.304	0.034	0.096	2.915	0.366	0.927	0.000	00:30:00		
01:30	0.302	0.034	0.089	3.322	0.502	0.934	0.000	00:30:00		
02:00	0.350	0.034	0.075	3.646	0.381	0.886	0.000	00:30:00		
02:30	0.323	0.034	0.064	2.788	0.340	0.894	0.000	00:30:00		
03:00	0.312	0.035	0.064	3.339	0.286	0.845	0.000	00:30:00		
03:30	0.301	0.035	0.062	3.729	0.358	0.901	0.000	00:30:00		
04:00	0.303	0.035	0.063	3.489	0.368	0.902	0.000	00:30:00		
04:30	0.328	0.036	0.077	2.861	0.285	0.841	0.000	00:30:00		
05:00	0.336	0.035	0.079	3.236	0.287	0.885	0.000	00:30:00		
05:30	0.304	0.036	0.077	3.590	0.314	0.948	0.000	00:30:00		
06:00	0.313	0.036	0.098	3.118	0.248	0.997	0.000	00:30:00		
06:30	0.335	0.035	0.100	2.923	0.320	0.952	0.000	00:30:00		
07:00	0.313	0.036	0.098	3.118	0.248	0.997	0.000	00:30:00		
07:30	0.291	0.036	0.085	3.676	0.349	1.048	0.000	00:30:00		
08:00	0.319	0.036	0.088	3.130	0.334	1.054	0.000	00:30:00		
08:30	0.333	0.036	0.092	2.860	0.328	1.091	0.000	00:30:00		
09:00	0.326	0.036	0.096	3.220	0.297	1.285	0.000	00:30:00		
09:30	0.316	0.035	0.102	3.152	0.361	1.348	0.000	00:30:00		
10:00	0.335	0.035	0.099	3.492	0.423	1.431	0.000	00:30:00		
10:30	0.338	0.034	0.089	2.798	0.276	1.371	0.000	00:30:00		
11:00	0.293	0.035	0.082	3.097	0.288	1.395	0.000	00:30:00		
11:30	0.310	0.034	0.078	3.497	0.316	1.312	0.001	00:30:00		
12:00	0.348	0.034	0.082	3.325	0.335	1.187	0.004	00:30:00		
12:30	2.708	0.117	0.071	2.930	0.342	1.255	0.009	00:30:00		
13:00	0.330	0.034	0.080	3.448	0.286	1.188	0.007	00:30:00		
13:30	0.318	0.034	0.082	4.197	0.619	1.215	0.008	00:30:00		
14:00	0.316	0.032	0.108	3.026	0.416	1.080	0.004	00:30:00		
14:30	0.345	0.033	0.128	3.024	0.384	1.091	0.007	00:30:00		
15:00	0.361	0.031	0.121	3.902	0.520	1.083	0.008	00:30:00		
15:30	0.311	0.032	0.113	2.774	0.547	1.079	0.007	00:30:00		
16:00	0.339	0.031	0.125	3.238	0.336	1.009	0.007	00:30:00		
16:30	0.297	0.032	0.103	2.803	0.326	1.016	0.006	00:30:00		
17:00	0.331	0.032	0.111	3.948	0.418	1.047	0.008	00:30:00		
17:30	0.293	0.030	0.093	3.135	0.389	0.980	0.003	00:30:00		
18:00	0.325	0.032	0.099	2.982	0.301	0.959	0.000	00:30:00		
18:30	0.336	0.030	0.087	2.911	0.285	0.944	0.000	00:30:00		
19:00	0.323	0.031	0.091	3.450	0.313	0.920	0.000	00:30:00		
19:30	0.341	0.030	0.083	2.975	0.323	0.885	0.000	00:30:00		
20:00	0.317	0.030	0.079	3.085	0.281	0.848	0.000	00:30:00		
20:30	0.330	0.030	0.096	3.225	0.270	0.779	0.000	00:30:00		
21:00	0.324	0.030	0.071	3.744	0.336	0.841	0.000	00:30:00		
21:30	0.334	0.031	0.059	3.146	0.246	0.775	0.000	00:30:00		
22:00	0.353	0.033	0.055	3.183	0.273	0.770	0.000	00:30:00		
22:30	0.343	0.034	0.051	3.781	0.389	0.803	0.000	00:30:00		
23:00	0.377	0.032	0.030	3.172	0.284	0.825	0.000	00:30:00		
23:30	0.331	0.032	0.046	2.215	0.365	0.782	0.001	00:30:00		
00:00	0.358	0.032	0.046	2.408	0.296	0.765	0.004	00:30:00		
Min	0.291	0.030	0.046	2.115	0.246	0.765	0.000			
Max	2.708	0.117	0.128	4.197	0.619	1.431	0.009			
Summ	18.025	1.683	4.059	153.759	16.828	43.291	0.081	24:00:00		
Dep VLE Flux Jour	0	0	0	1	0	0	0			

FICHE D'INCIDENT N°19/009

Date de l'incident : 19/03/2019

Date d'ouverture de la fiche : 08/07/2019

Destinataire :

DRIEE Mail : mary-ann.mathieu@developpement-durable.gouv.fr
 Préfecture Fax 01 49 56 64 08..... (Tél 01 49 56 60 00)
 SMITDUVM Mail : kiken@gpsea.fr et amvinois@gpsea
 Autres Fax Tél.....

Secteur de l'usine touché :

Heureà.....

EMERAUDE

- Hall de déchargement
- Fosse
- Fours/chaudières
- Traitement fumées / effluent
- Bâtiment administratif
- Tours aéroréfrigérantes

DAS

- Hall de déchargement
- Bâtiment administratif
- Manutention
- Four /Chaudières
- Traitement fumées / effluent
- Tour aéroréfrigérante

AUTRE

- Rejet liquide usine
- Voies de circulation
- Environnement usine

Evaluation de la situation :

- Problème d'incendie
- Problème d'analyseur
- Problème de pollution
 - Dégagement de fumées
 - Dépassement de seuils polluants
 - Dépassement du seuil en légionelles de 100 000 UFC/l
 - Pollution accidentelle au niveau du stockage des produits
 - Huile Fioul Autres :
- Impact sonore
- Impact visuel

Etat de la situation :

- Maîtrisé Non maîtrisé En cours de traitement
- PIOS déclenché Dégât matériel : Victime /état :

Origine du problème rencontré :

Dépassement de la moyenne journalière en HCl de la ligne DAS à 11,2 mg/Nm3 (pour un seuil à 10) lors du contrôle réglementaire des rejets de polluants à l'atmosphère du 1er semestre 2019 (rapport LECES reçu le 08 juillet pour des prélèvements réalisés le 19 mars). Le rapport jour d'auto surveillance était conforme à 7,68 mg/Nm3.

Cause :

- Non identifiée
- Identifiée :

Moyens déjà engagés :

- Comparaisons des valeurs mesurées lors du contrôle réglementaire par rapport aux valeurs mesurées par les analyseurs en cheminée : autosurveillance à 7,68 mg/Nm3 sur toute la journée. L'incertitude sur la mesure n'est pas appliquée par le laboratoire externe.
- Vérification des mesures des flux HCl sur la journée : conformes (en contrôle réglementaire et en autosurveillances, résultats bien inférieurs à 5,85 kg/j)
- Sensibilisation des équipes de quart sur la surveillance de la bonne injection de chaux

Moyens complémentaires à demander : voir prochain résultat du contrôle réglementaire du 2° semestre 2019 qui aura lieu en Octobre 2019.

Pièces jointes : Rapport du contrôle réglementaire et rapports jour auto surveillance du 19/03/2019 (en flux et concentration)

Nom, fonction et signature du déclarant :

Marie-Christine VIRATELLE, Directrice de Site



VALO'MARNE

10/11, rue des Malfourches
94034 CRETEIL Cédex
Tél. : 01.48.98.55.11
Fax : 01.48.98.48.83
SIRET : 833 921 232 00017

Rapport DREAL Journalier Ligne 4

Rapport journalier													14 Mars 2019	
Mesure IC95 Ligne4														
Unité	CO mg/Nm3	COT mg/Nm3	HCL mg/Nm3	NH3 mg/Nm3	NOX mg/Nm3	POUSSIERRE mg/Nm3	SO2 mg/Nm3	Vitesse30_T4_2C m/s	O2 %	T28_30_L4 degréC	MarcheFourL4_30 h:mm:ss	Tonnage DA8RI Tonne		
VLE 1/2h	100	20	20	60	20	30	200							
VLE max	100					150								
Seuil Min.									12		850			
VLE Jour	50	10	10	10	10	10	50							
00:30	3.77	0.00	6.60	0.78	53.55	1.202	3.62	15.75	11.30	987.2	00:30:00	0.0		
01:00	Arrêt	Arrêt	Arrêt	Arrêt	Arrêt	Arrêt	Arrêt	Arrêt	Arrêt	Arrêt	00:16:20	0.0		
01:30	2.62	0.00	6.21	0.66	56.21	1.109	3.75	14.38	10.45	978.3	00:30:00	0.0		
02:00	2.75	0.00	9.01	0.77	67.53	1.214	4.60	16.63	11.43	993.3	00:30:00	0.0		
02:30	3.27	0.00	9.20	0.68	57.13	1.126	3.81	14.68	10.55	990.7	00:30:00	0.0		
03:00	3.13	0.00	9.67	0.66	71.41	1.029	3.15	14.79	9.75	1004.8	00:30:00	0.0		
03:30	3.47	0.02	14.41	0.76	73.24	1.236	4.37	18.05	11.55	1004.3	00:30:00	0.0		
04:00	4.85	0.04	8.25	0.81	49.37	1.237	3.02	16.29	11.76	976.6	00:30:00	0.0		
04:30	6.79	0.03	6.46	0.80	55.16	1.164	2.46	16.00	10.81	983.8	00:30:00	0.0		
05:00	3.21	0.00	13.19	0.74	76.46	1.183	4.20	16.60	10.94	1003.9	00:30:00	0.0		
05:30	Arrêt	Arrêt	Arrêt	Arrêt	Arrêt	Arrêt	Arrêt	Arrêt	Arrêt	Arrêt	00:08:00	0.0		
06:00	Arrêt	Arrêt	Arrêt	Arrêt	Arrêt	Arrêt	Arrêt	Arrêt	Arrêt	Arrêt	00:00:00	0.0		
06:30	Arrêt	Arrêt	Arrêt	Arrêt	Arrêt	Arrêt	Arrêt	Arrêt	Arrêt	Arrêt	00:00:20	0.0		
07:00	0.07	0.02	4.68	0.64	70.81	1.321	2.53	17.37	11.82	944.6	00:30:00	0.0		
07:30	39.50	0.40	5.53	0.53	59.47	1.449	3.28	19.98	12.49	955.5	00:30:00	0.0		
08:00	7.72	0.29	3.23	1.06	74.64	1.319	2.66	21.34	11.71	960.5	00:30:00	0.0		
08:30	8.44	0.16	3.58	1.05	55.39	1.350	2.95	22.11	12.07	991.3	00:30:00	0.0		
09:00	9.62	0.07	3.83	0.96	67.69	1.389	3.04	21.75	11.90	998.6	00:30:00	0.0		
09:30	Arrêt	Arrêt	Arrêt	Arrêt	Arrêt	Arrêt	Arrêt	Arrêt	Arrêt	Arrêt	00:07:00	101.2		
10:00	11.26	0.03	3.93	0.69	44.32	1.321	3.54	16.44	11.59	939.7	00:24:30	0.0		
10:30	16.23	0.04	4.25	0.91	48.91	1.241	3.78	16.71	11.84	963.2	00:30:00	0.0		
11:00	41.69	0.11	4.47	0.90	55.81	1.214	3.60	16.85	11.78	954.6	00:30:00	0.0		
11:30	50.33	0.08	4.62	0.87	74.74	1.196	2.96	18.39	11.53	973.3	00:30:00	0.0		
12:00	15.24	0.00	4.47	0.86	56.12	1.189	2.71	17.40	11.71	972.8	00:30:00	0.0		
12:30	5.80	0.00	5.25	0.88	61.08	1.213	3.01	17.22	11.88	976.3	00:30:00	0.0		
13:00	2.74	0.03	5.25	0.78	66.56	1.142	2.84	17.93	11.61	983.9	00:30:00	0.0		
13:30	1.78	0.08	7.31	0.72	78.92	1.185	3.41	18.48	11.84	1001.1	00:30:00	0.0		
14:00	1.11	0.00	5.53	0.70	81.43	1.162	2.87	19.44	11.66	1009.6	00:30:00	0.0		
14:30	1.13	0.00	7.36	0.67	74.91	1.148	2.94	18.88	11.66	1013.9	00:30:00	0.0		
15:00	6.87	0.02	8.23	0.70	42.89	1.202	2.67	17.46	11.95	978.7	00:30:00	0.0		
15:30	11.73	0.04	7.26	0.88	57.79	1.201	2.71	20.21	11.93	978.8	00:30:00	0.0		
16:00	8.66	0.16	8.87	0.85	67.74	1.196	3.07	19.84	12.01	993.3	00:30:00	0.0		
16:30	9.23	0.16	12.51	0.89	60.06	1.156	3.94	17.45	11.74	985.7	00:30:00	0.0		
17:00	8.27	0.12	15.30	0.65	63.08	1.167	3.61	18.44	11.81	980.7	00:30:00	0.0		
17:30	0.00	0.02	9.87	0.64	152.98	1.135	4.51	19.51	11.40	1053.9	00:30:00	0.0		
18:00	Arrêt	Arrêt	Arrêt	Arrêt	Arrêt	Arrêt	Arrêt	Arrêt	Arrêt	Arrêt	00:14:30	0.0		
18:30	15.67	0.20	5.99	0.50	61.19	1.402	4.20	23.32	12.80	992.9	00:21:10	0.0		
19:00	5.08	0.09	4.82	1.07	46.67	1.319	3.37	22.23	12.16	941.0	00:30:00	0.0		
19:30	15.41	0.05	9.50	0.56	48.83	1.228	4.75	17.79	11.85	987.2	00:30:00	0.0		
20:00	3.29	0.00	11.23	0.84	66.86	1.187	4.68	17.85	11.55	978.0	00:30:00	0.0		
20:30	1.00	0.00	20.47	0.64	149.95	1.159	6.89	20.39	11.30	1048.1	00:30:00	0.0		
21:00	0.77	0.00	11.57	0.70	135.90	1.181	4.53	21.50	11.53	1052.0	00:30:00	0.0		
21:30	3.15	0.00	10.41	0.86	188.83	1.148	3.36	22.59	10.82	1099.8	00:30:00	0.0		
22:00	1.17	0.00	5.61	0.77	155.74	1.169	2.51	21.88	11.29	1083.3	00:30:00	0.0		
22:30	2.39	0.00	8.29	0.51	86.87	1.240	3.60	20.29	11.98	1022.7	00:30:00	0.0		
23:00	4.02	0.03	5.40	0.60	56.76	1.231	4.11	20.07	11.87	995.4	00:30:00	0.0		
23:30	4.31	0.11	5.67	0.69	59.90	1.294	4.11	21.69	12.04	989.7	00:30:00	0.0		
00:00	4.01	0.04	5.09	0.73	64.39	1.272	3.59	20.05	11.76	990.2	00:30:00	0.0		
Max.	50.33	0.40	20.47	1.07	188.83	1.449	6.89	23.32	12.80	1099.8		101.2		
Min.	0.00	0.00	3.23	0.51	42.89	1.029	2.46	14.38	9.75	941.0		0.0		
Moy/Cumul	8.23	0.06	7.68	0.78	73.61	1.218	3.66	18.71	11.61	993.3	21:31:30	101.2		
Dép. VLE 1/2h	0	0	0	0	0	0	0	0	0	0		0		
Dép. VLE max	00:00	00:00				00:00								
Dép. Seuil Min.									00:00	00:00				
Indisponibilité	0	0	0	0	0	0	0	0	0	0	0	0		
% données HG	0.00	0.00	0.00	0.00	0.00	0.00	0.00	0.00	0.00	0.00		0.00		
Invalidité	0	0	0	0	0	0	0	0	0	0		0		
Dép. VLE Jour	0	0	0	0	0	0	0	0	0	0		0		

Contrôle réglementaire L4 - 2019 (L4)									
	CO	COT	NOX	POUSSIERRE	SO2	O2	T28_30_L4	MarcheFourL4_30	Tonnage DA8RI
Dépassement >4H	0	0	0	0	0	0	0	0	0
Dép. VLE	00:00	09:00	00:00	00:00	00:00	00:00	00:00	00:00	09:00
Nb jour invalides	0	0	0	0	0	0	0	0	0
Indis. Cons >10h	0	0	0	0	0	0	0	0	0
Indisponibilité	00:00	02:30	00:00	00:00	00:00	00:00	00:00	00:00	02:30

Rapport DREAL Flux Journalier Ligne 4

Rapport Flux Journalier										19 Mars 2019
FLUX Ligne 4										
Unité	CO_30_FLUX_L4	COT_FLUX_L4	HCL_FLUX_L4	NOX_FLUX_L4	POUSS_FLUX_L4	SO2_FLUX_L4	NH3_FLUX_L4	MarcheFourL4_30		
Kg	Kg	Kg	Kg	Kg	Kg	Kg	Kg	hh:mm:ss		
VLE Flux Jour	23.25	5.85	5.85	58.5	4.69	17.55	5.85			
00:30	0.03	0.00	0.06	0.47	0.01	0.03	0.01	00:30:00		
01:00	Arrêt	Arrêt	Arrêt	Arrêt	Arrêt	Arrêt	Arrêt	00:16:20		
01:30	0.02	0.00	0.05	0.49	0.01	0.03	0.01	00:30:00		
02:00	0.03	0.00	0.08	0.62	0.01	0.04	0.01	00:30:00		
02:30	0.03	0.00	0.08	0.51	0.01	0.03	0.01	00:30:00		
03:00	0.03	0.00	0.09	0.69	0.01	0.03	0.01	00:30:00		
03:30	0.03	0.00	0.14	0.72	0.01	0.04	0.01	00:30:00		
04:00	0.04	0.00	0.07	0.38	0.01	0.03	0.01	00:30:00		
04:30	0.06	0.00	0.06	0.52	0.01	0.02	0.01	00:30:00		
05:00	0.03	0.00	0.13	0.73	0.01	0.04	0.01	00:30:00		
05:30	Arrêt	Arrêt	Arrêt	Arrêt	Arrêt	Arrêt	Arrêt	00:08:00		
06:00	Arrêt	Arrêt	Arrêt	Arrêt	Arrêt	Arrêt	Arrêt	00:00:00		
06:30	Arrêt	Arrêt	Arrêt	Arrêt	Arrêt	Arrêt	Arrêt	00:00:20		
07:00	0.00	0.00	0.04	0.66	0.01	0.02	0.01	00:30:00		
07:30	0.38	0.00	0.05	0.58	0.01	0.03	0.01	00:30:00		
08:00	0.09	0.00	0.04	0.84	0.01	0.03	0.01	00:30:00		
08:30	0.09	0.00	0.04	0.62	0.02	0.03	0.01	00:30:00		
09:00	0.04	0.00	0.04	0.76	0.02	0.03	0.01	00:30:00		
09:30	Arrêt	Arrêt	Arrêt	Arrêt	Arrêt	Arrêt	Arrêt	00:07:00		
10:00	0.08	0.00	0.03	0.33	0.01	0.03	0.01	00:24:30		
10:30	0.14	0.00	0.04	0.43	0.01	0.03	0.01	00:30:00		
11:00	0.38	0.00	0.04	0.50	0.01	0.03	0.01	00:30:00		
11:30	0.51	0.00	0.05	0.76	0.01	0.03	0.01	00:30:00		
12:00	0.14	0.00	0.04	0.53	0.01	0.03	0.01	00:30:00		
12:30	0.05	0.00	0.05	0.55	0.01	0.03	0.01	00:30:00		
13:00	0.03	0.00	0.05	0.65	0.01	0.03	0.01	00:30:00		
13:30	0.02	0.00	0.07	0.77	0.01	0.03	0.01	00:30:00		
14:00	0.01	0.00	0.06	0.85	0.01	0.03	0.01	00:30:00		
14:30	0.01	0.00	0.07	0.76	0.01	0.03	0.01	00:30:00		
15:00	0.06	0.00	0.07	0.39	0.01	0.02	0.01	00:30:00		
15:30	0.12	0.00	0.08	0.60	0.01	0.03	0.01	00:30:00		
16:00	0.09	0.00	0.09	0.69	0.01	0.03	0.01	00:30:00		
16:30	0.09	0.00	0.12	0.56	0.01	0.04	0.01	00:30:00		
17:00	0.08	0.00	0.15	0.61	0.01	0.03	0.01	00:30:00		
17:30	0.00	0.00	0.11	1.63	0.01	0.05	0.01	00:30:00		
18:00	Arrêt	Arrêt	Arrêt	Arrêt	Arrêt	Arrêt	Arrêt	00:14:30		
18:30	0.12	0.00	0.05	0.46	0.01	0.03	0.01	00:21:10		
19:00	0.06	0.00	0.05	0.52	0.01	0.04	0.01	00:30:00		
19:30	0.14	0.00	0.09	0.45	0.01	0.04	0.01	00:30:00		
20:00	0.03	0.00	0.11	0.64	0.01	0.04	0.01	00:30:00		
20:30	0.01	0.00	0.23	1.68	0.01	0.08	0.01	00:30:00		
21:00	0.01	0.00	0.13	1.56	0.01	0.05	0.01	00:30:00		
21:30	0.04	0.00	0.13	2.40	0.01	0.04	0.01	00:30:00		
22:00	0.01	0.00	0.07	1.86	0.01	0.03	0.01	00:30:00		
22:30	0.03	0.00	0.09	0.91	0.01	0.04	0.01	00:30:00		
23:00	0.04	0.00	0.06	0.59	0.01	0.04	0.01	00:30:00		
23:30	0.05	0.00	0.06	0.66	0.01	0.05	0.01	00:30:00		
00:00	0.04	0.00	0.05	0.68	0.01	0.04	0.01	00:30:00		
Min	0.00	0.00	0.03	0.33	0.01	0.02	0.01			
Max	0.51	0.00	0.23	2.40	0.02	0.08	0.01			
Cumul	3.29	0.00	3.21	31.61	0.44	1.45	0.42	21:31:50		
Dep. VLE Flux Jour	0	0	0	0	0	0	0			

FICHE D'INCIDENT N°19/007

19/010

Date de l'incident : 27/07/2019

Date d'ouverture de la fiche : 29/07/2019

Destinataire :

- DRIEE Mail : mary-anne.mathieu@developpement-durable.gouv.fr
 Préfecture Fax 01 49 56 64 08..... (Tél 01 49 56 60 00)
 SMITDUVM Mail : kiken@gpsea.fr et amvinois@gpsea
 Autres Fax Tél.....

Secteur de l'usine touché :

Heure : à

EMERAUDE

- Hall de déchargement
 Fosse
 Fours/chaudières
 Traitement fumées / effluent
 Bâtiment administratif
 Tours aéroréfrigérantes

DAS

- Hall de déchargement
 Bâtiment administratif
 Manutention
 Four /Chaudières
 Traitement fumés / effluent
 Tour aéroréfrigérante

AUTRE

- Rejet liquide usine
 Voies de circulation
 Environnement usine

Evaluation de la situation :

- Problème d'incendie
 Problème d'analyseur
 Problème de pollution
 Dégagement de fumées
 Dépassement de seuils polluants
 Dépassement du seuil en légionelles de 100 000 UFC/l
 Pollution accidentelle au niveau du stockage des produits
 Huile Fioul Autres :
- Impact sonore
 Impact visuel

Etat de la situation :

- Maîtrisé Maîtrisé Non maîtrisé En cours de traitement
 PIOS déclenché Dégât matériel : Victime /état :

Origine du problème rencontré :

La moyenne journalière de température des rejets liquides a atteint 30,81 °C (pour un seuil à 30 °C).

Cause :

- Non identifiée
 Identifiée : La température ambiante est élevée en cette période estivale et caniculaire.

Moyens déjà engagés :

- Contrôle des températures de l'ensemble des effluents du site.
- Nettoyage de l'échangeur à plaques pour le refroidissement des effluents d'EMERAUDE.

Moyens complémentaires à demander : /

Pièces jointes : Rapports journalier du 27/07/2019

Nom, fonction et signature du déclarant :

Claude LEBRUN, Responsable de Site

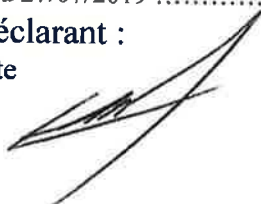





Rapport Rejet AQ Jour

27 Juillet 2019

Rapport journalier		Rejet liquide																	
Unité	Scail Max	Scail Min	Valeur Limite d' Emission journalière	Débit	Pb	Volume Ph		Temp Ph		Volume Température	Température	Temp	Température	Température	Température	Température	Température		
						Inf/Dep.	Inf/Dep.	Sup/Dep.	Sup/Dep.									Inf/Dep.	Inf/Dep.
	m3/h					m3	m3	hr:min:ss	hr:min:ss	m3	degreC	degreC	degreC	degreC	degreC	degreC	degreC		
01:00	11.66	7.25	0.00	00:00:00	0.00	00:00:00	0.00	00:00:00	0.00	11.69	01:00:00	19.59	0.00	00:00:00	4.94	0.00	00:00:00	01:00:00	11.69
02:00	12.76	7.28	0.00	00:00:00	0.00	00:00:00	0.00	00:00:00	0.00	12.73	01:00:00	23.79	0.00	00:00:00	14.12	0.00	00:00:00	01:00:00	12.73
03:00	12.79	7.45	0.00	00:00:00	0.00	00:00:00	0.00	00:00:00	0.00	12.73	01:00:00	22.44	0.00	00:00:00	17.50	0.00	00:00:00	01:00:00	12.73
04:00	13.99	7.39	0.00	00:00:00	0.00	00:00:00	0.00	00:00:00	0.00	14.04	01:00:00	21.24	0.00	00:00:00	15.99	0.00	00:00:00	01:00:00	14.04
05:00	12.31	7.25	0.00	00:00:00	0.00	00:00:00	0.00	00:00:00	0.00	12.30	01:00:00	23.92	0.00	00:00:00	16.34	0.00	00:00:00	01:00:00	12.30
06:00	13.71	6.97	0.00	00:00:00	0.00	00:00:00	0.00	00:00:00	0.00	13.76	01:00:00	21.32	0.00	00:00:00	16.30	0.00	00:00:00	01:00:00	13.76
07:00	12.19	6.95	0.00	00:00:00	0.00	00:00:00	0.00	00:00:00	0.00	12.07	01:00:00	19.81	0.00	00:00:00	11.39	0.00	00:00:00	01:00:00	12.07
08:00	8.87	6.74	0.00	00:00:00	0.00	00:00:00	0.00	00:00:00	0.00	8.92	01:00:00	18.96	0.00	00:00:00	10.95	0.00	00:00:00	01:00:00	8.92
09:00	2.46	6.77	0.00	00:00:00	0.00	00:00:00	0.00	00:00:00	0.00	1.71	00:26:50	16.73	0.00	00:00:00	3.38	0.00	00:00:00	01:00:00	2.49
10:00	6.83	6.70	0.00	00:00:00	0.00	00:00:00	0.00	00:00:00	0.00	6.57	00:50:20	21.88	0.00	00:00:00	3.62	0.00	00:00:00	01:00:00	6.86
11:00	8.16	6.48	0.00	00:00:00	0.00	00:00:00	0.00	00:00:00	0.00	8.18	01:00:00	22.05	0.00	00:00:00	2.58	0.00	00:00:00	01:00:00	8.18
12:00	9.92	6.39	0.00	00:00:00	0.00	00:00:00	0.00	00:00:00	0.00	9.87	01:00:00	18.23	0.00	00:00:00	1.88	0.00	00:00:00	01:00:00	9.87
13:00	10.03	6.38	0.00	00:00:00	0.00	00:00:00	0.00	00:00:00	0.00	9.94	01:00:00	19.23	0.00	00:00:00	1.84	0.00	00:00:00	01:00:00	9.94
14:00	9.98	6.33	0.00	00:00:00	0.00	00:00:00	0.00	00:00:00	0.00	9.99	01:00:00	19.99	0.00	00:00:00	1.85	0.00	00:00:00	01:00:00	9.99
15:00	9.98	6.33	0.00	00:00:00	0.00	00:00:00	0.00	00:00:00	0.00	9.95	01:00:00	19.20	0.00	00:00:00	1.81	0.00	00:00:00	01:00:00	9.95
16:00	9.86	6.33	0.00	00:00:00	0.00	00:00:00	0.00	00:00:00	0.00	9.92	01:00:00	19.90	0.00	00:00:00	1.80	0.00	00:00:00	01:00:00	9.92
17:00	6.21	6.38	0.00	00:00:00	0.00	00:00:00	0.00	00:00:00	0.00	6.17	01:00:00	19.54	0.00	00:00:00	1.82	0.00	00:00:00	01:00:00	6.17
18:00	13.62	6.96	0.00	00:00:00	0.00	00:00:00	0.00	00:00:00	0.00	12.34	00:53:50	21.08	0.00	00:00:00	2.58	0.00	00:00:00	01:00:00	13.69
19:00	16.82	7.16	0.00	00:00:00	0.00	00:00:00	0.00	00:00:00	0.00	16.94	01:00:00	15.47	0.00	00:00:00	3.72	0.00	00:00:00	01:00:00	16.94
20:00	15.37	7.24	0.00	00:00:00	0.00	00:00:00	0.00	00:00:00	0.00	15.55	01:00:00	16.53	0.00	00:00:00	3.69	0.00	00:00:00	01:00:00	15.55
21:00	16.59	7.08	0.00	00:00:00	0.00	00:00:00	0.00	00:00:00	0.00	16.54	01:00:00	15.94	0.00	00:00:00	4.29	0.00	00:00:00	01:00:00	16.54
22:00	14.93	7.09	0.00	00:00:00	0.00	00:00:00	0.00	00:00:00	0.00	15.00	01:00:00	15.35	0.00	00:00:00	3.93	0.00	00:00:00	01:00:00	15.00
23:00	16.06	7.01	0.00	00:00:00	0.00	00:00:00	0.00	00:00:00	0.00	16.12	01:00:00	15.27	0.00	00:00:00	3.77	0.00	00:00:00	01:00:00	16.12
00:00	13.50	7.00	0.00	00:00:00	0.00	00:00:00	0.00	00:00:00	0.00	13.40	00:59:20	15.40	0.00	00:00:00	3.31	0.00	00:00:00	01:00:00	13.49
Max	16.82	7.45	0.00	00:00:00	0.00	00:00:00	0.00	00:00:00	0.00	16.94	01:00:00	23.92	0.00	00:00:00	17.50	0.00	00:00:00	01:00:00	16.94
Min	2.46	6.33	0.00	00:00:00	0.00	00:00:00	0.00	00:00:00	0.00	1.71	00:26:50	15.27	0.00	00:00:00	1.80	0.00	00:00:00	01:00:00	2.49
Moy/Cours	11.61	6.87	0.00	00:00:00	0.00	00:00:00	0.00	00:00:00	0.00	276.43	23:10:20	19.29	0.00	00:00:00	6.39	0.00	00:00:00	24:06:00	178.94
Dép. Scail Max		00:00:00	0.00	00:00:00	0.00	00:00:00	0.00	00:00:00	0.00				0.00	00:00:00		0.00	00:00:00	01:00:00	
Dép. Scail Min		00:00:00	0.00	00:00:00	0.00	00:00:00	0.00	00:00:00	0.00				0.00	00:00:00		0.00	00:00:00	01:00:00	
Indep/Inf/Min	0	0	0	0	0	0	0	0	0	0	0	0	0	0	0	0	0	0	0
Dép. Scail Jour																			

 RECYCLAGE ET VALORISATION FRANCE  NOTRE TERRITOIRE A DE L'ENERGIE	BL Infrastructures Direction Valorisation Energétique IDF	APPLICATION : Obligatoire / Recommandé / Informatif
	FICHE D'INCIDENT	DIFFUSION : Confidentiel / Restreint / Interne / Public
		REFERENCE : 09 VLM ENG Fiche d'incident V9 du 24 septembre 2019
		STATUT : Approuvé / En-révision / Périmé

FICHE D'INCIDENT N° 19 - 011

Date de l'incident : 23/10/2019 Heure : 00h00 à 00h00 Date d'ouverture de la fiche : 24/10/2019

Destinataires :

DRIEE- IF
ud94.driee-if@developpement-durable.gouv.fr ;
mary-anne.mathieu@developpement-durable.gouv.fr ;
jean-marie.chabane@developpement-durable.gouv.fr ;
xavier.charon@developpement-durable.gouv.fr

Préfecture
pref-environnement@val-de-marne.gouv.fr
 SMITDUVM
kikeni@gpsea.fr ; amvinois@gpsea.fr
 Autre

Secteur de l'usine touché :

- EMERAUDE**
- Hall de déchargement
 - Fosse
 - Fours/chaudières
 - Traitement fumées / effluent
 - Bâtiment administratif
 - Tours aéroréfrigérante

- DAS**
- Hall de déchargement
 - Bâtiment administratif
 - Manutention
 - Four /Chaudières
 - Traitement fumés / effluent
 - Tour aéroréfrigérante

- AUTRE**
- Rejet liquide usine
 - Voies de circulation
 - Environnement usine

Evaluation de la situation :

- Problème d'incendie
- Problème d'analyseur
- Impact sonore
- Impact visuel
- Problème de pollution
 - Dégagement de fumées
 - Dépassement de seuils polluants
 - Dépassement du seuil en légionelles de 100 000 UFC/l
 - Pollution accidentelle au niveau du stockage des produits
 - Huile Fioul
 - Autres :

Etat de la situation :

- Maîtrisé
- Non maîtrisé
- En cours de traitement
- PIOS déclenché
- Dégât matériel :
- Victime /état :

Origine du problème rencontré :

- Non identifiée
- Identifiée :

Dépassement de la moyenne journalière en HCl de la ligne DAS à 10,42 mg/Nm3 (pour un seuil à 10 mg/Nm3), suite au bouchage de la tuyauterie d'injection de chaux éteinte au niveau du filtre à manches.

Moyens déjà engagés : Mise à l'arrêt de l'enfournement des DASRI à 19h08, débouchage du circuit d'injection de chaux éteinte par l'équipe de quart. Reprise de l'enfournement à 20h21.

Moyens complémentaires à demander : Automatisation du percuteur au niveau de la trémie du Skid d'injection de chaux éteinte afin d'éviter les bouchages de la tuyauterie (réalisation programmé 25/10/2019 par le service maintenance).

Pièces jointes :
 Rapport journalier d'auto surveillance du 23/10/2019

Nom, fonction et signature du déclarant :

VALO'MARNE
 10/11, rue des Malfourches
 94034 CRETEIL Cedex
 Tél. : 01.48.98.55.11
 Fax : 01.48.98.48.83
 SIRET : 833 921 232 00017



Claude LEBRUN, Responsable de Site



Rapport DREAL Journalier Ligne 4

Rapport journalier													23/10/2019	
Mesure IC95 Ligne4														
Unité	CO mg/Nm3	COT mg/Nm3	HCL mg/Nm3	NH3 mg/Nm3	NOX mg/Nm3	POUSSIERE mg/Nm3	SO2 mg/Nm3	Vitesse30_T4_2C m/s	O2 %	T2S_30_I4 degreC	MarcheFourL4_30 hh:mm:ss	Tonnage DASRI Tonne		
VLE 1/2h	100	20	20	60	20	30	200							
VLE max	100	20	20			150								
Seuil Min.														
VLE Jour	50	10	10	10	10	100	50	12		850				
00:30	1.91	0.00	7.01	1.85	72.19	0.271	1.50	17.02	9.69	977.4	00:30:00	0.0		
01:00	1.25	0.00	8.95	1.70	88.87	0.272	1.26	17.88	9.33	1022.9	00:30:00	0.0		
01:30	3.06	0.00	11.87	1.63	48.36	0.271	1.44	15.40	9.74	988.9	00:30:00	0.0		
02:00	3.58	0.00	12.25	1.69	60.96	0.271	1.29	16.10	9.55	985.6	00:30:00	0.0		
02:30	1.86	0.00	13.48	1.65	70.21	0.258	1.74	16.78	9.43	1009.0	00:30:00	0.0		
03:00	5.10	0.00	13.29	1.96	50.36	0.277	1.57	16.61	10.08	977.3	00:30:00	0.0		
03:30	1.95	0.00	13.40	2.02	91.68	0.258	1.15	20.19	9.26	1024.0	00:30:00	0.0		
04:00	1.65	0.00	14.40	2.12	90.16	0.271	0.92	19.31	9.56	1031.7	00:30:00	0.0		
04:30	2.35	0.00	12.17	2.22	61.91	0.272	0.82	17.50	9.49	1013.0	00:30:00	0.0		
05:00	1.59	0.00	11.76	2.29	100.60	0.273	0.68	20.17	9.34	1038.6	00:30:00	0.0		
05:30	1.71	0.00	13.14	2.11	61.35	0.276	0.79	17.04	9.57	1009.1	00:30:00	0.0		
06:00	1.85	0.00	14.75	2.00	66.39	0.263	0.59	18.70	9.25	1013.3	00:30:00	0.0		
06:30	2.82	0.00	14.23	2.42	51.75	0.277	0.77	17.43	9.59	998.3	00:30:00	0.0		
07:00	5.19	0.00	8.66	2.24	41.85	0.269	0.54	17.74	9.31	991.9	00:30:00	0.0		
07:30	1.51	0.00	10.33	2.17	114.08	0.306	0.57	24.08	8.43	1058.5	00:30:00	0.0		
08:00	2.05	0.00	11.89	2.48	53.63	0.297	1.02	18.58	9.47	1006.3	00:30:00	0.0		
08:30	3.48	0.00	9.06	2.46	35.06	0.278	1.19	17.16	9.64	985.4	00:30:00	0.0		
09:00	2.92	0.00	9.76	2.53	54.64	0.284	1.42	20.21	9.38	1002.4	00:30:00	0.0		
09:30	1.65	0.00	10.13	2.61	67.61	0.270	1.26	19.91	9.38	1014.2	00:30:00	0.0		
10:00	1.78	0.00	10.48	2.53	65.87	0.279	1.07	20.12	9.36	1016.0	00:30:00	0.0		
10:30	3.44	0.00	10.49	2.34	68.07	0.280	0.70	18.47	9.33	1016.7	00:30:00	0.0		
11:00	3.07	0.00	10.84	2.44	51.75	0.287	0.86	18.42	9.66	1001.4	00:30:00	0.0		
11:30	3.11	0.00	10.04	2.32	42.18	0.273	0.89	17.63	9.75	980.0	00:30:00	0.0		
12:00	2.11	0.00	9.53	2.33	73.03	0.259	0.95	18.09	9.32	997.0	00:30:00	0.0		
12:30	2.45	0.00	11.99	2.46	77.44	0.277	1.16	21.14	9.45	1013.4	00:30:00	0.0		
13:00	3.02	0.00	13.59	2.50	59.35	0.273	1.21	20.36	9.42	999.5	00:30:00	0.0		
13:30	2.66	0.00	13.32	2.47	30.97	0.278	0.92	16.21	9.41	982.6	00:30:00	0.0		
14:00	2.52	0.00	11.70	2.36	58.83	0.280	0.59	17.03	9.72	975.5	00:24:10	0.0		
14:30	Arrêt	Arrêt	Arrêt	Arrêt	Arrêt	Arrêt	Arrêt	Arrêt	Arrêt	Arrêt	00:17:50	0.0		
15:00	Arrêt	Arrêt	Arrêt	Arrêt	Arrêt	Arrêt	Arrêt	Arrêt	Arrêt	Arrêt	00:00:00	0.0		
15:30	Arrêt	Arrêt	Arrêt	Arrêt	Arrêt	Arrêt	Arrêt	Arrêt	Arrêt	Arrêt	00:09:20	0.0		
16:00	56.96	0.12	5.47	1.68	46.79	0.273	1.16	14.39	10.14	942.4	00:30:00	0.0		
16:30	2.96	0.00	6.23	1.72	67.72	0.270	1.48	13.69	9.66	961.9	00:30:00	0.0		
17:00	2.17	0.00	7.23	1.83	74.65	0.256	1.46	15.27	9.25	986.8	00:30:00	0.0		
17:30	3.28	0.00	14.48	1.78	93.00	0.261	2.20	16.77	9.49	1026.0	00:29:30	0.0		
18:00	4.66	0.00	13.17	2.23	36.34	0.283	1.21	14.11	10.37	957.5	00:30:00	0.0		
18:30	1.89	0.00	11.33	1.98	61.94	0.273	1.49	14.81	9.51	977.1	00:30:00	0.0		
19:00	1.82	0.00	12.05	2.25	65.64	0.267	1.48	15.99	9.72	960.4	00:30:00	0.0		
19:30	1.51	0.01	15.78	2.25	79.34	0.262	1.92	20.08	9.21	999.3	00:25:00	0.0		
20:00	Arrêt	Arrêt	Arrêt	Arrêt	Arrêt	Arrêt	Arrêt	Arrêt	Arrêt	Arrêt	00:00:00	0.0		
20:30	Arrêt	Arrêt	Arrêt	Arrêt	Arrêt	Arrêt	Arrêt	Arrêt	Arrêt	Arrêt	00:08:00	0.0		
21:00	42.12	0.00	5.51	1.58	52.34	0.290	1.66	13.92	10.63	937.2	00:30:00	0.0		
21:30	3.94	0.00	5.25	1.22	69.99	0.256	1.34	13.68	9.83	957.7	00:30:00	0.0		
22:00	1.99	0.00	4.85	1.14	65.42	0.248	1.33	14.21	9.45	981.6	00:30:00	0.0		
22:30	1.87	0.00	5.27	1.21	67.10	0.258	1.68	15.15	9.49	987.6	00:30:00	0.0		
23:00	1.23	0.00	5.14	1.16	88.76	0.263	1.93	16.12	9.28	1023.9	00:30:00	0.0		
23:30	2.27	0.00	7.06	1.19	45.13	0.265	2.97	14.40	9.82	986.0	00:27:00	0.0		
00:00	2.68	0.00	6.50	1.49	45.36	0.284	2.36	14.61	10.39	946.2	00:27:50	0.0		
Max.	56.96	0.12	15.78	2.61	114.08	0.306	2.97	24.08	10.63	1058.5		0.0		
Min.	1.23	0.00	4.85	1.14	35.06	0.248	0.54	13.68	8.43	937.2		0.0		
Moy/Cumul	4.72	0.00	10.42	2.01	64.85	0.272	1.27	17.27	9.57	994.5	21:48:40	0.0		
Dép. VLE 1/2h	0	0	0	0	0	0	0	0	0	0		0.0		
Dép. VLE max	00:00	00:00										0.0		
Dép. Seuil Min.												0.0		
Indisponibilité % données HG	0.00	0.00	0.00	0.00	0.00	0.00	0.00	0.00	0.00	0.00	0	0		
Invalidité	0	0	0	0	0	0	0	0	0	0	0	0.0		
Dép. VLE Jour	0	0	1	0	0	0	0	0	0	0	0	0.0		

Contrôle réglementaire (1 - 2019/10/23)												
	CO	HCL	NH3	NOX	POUSSIERE	SO2	Vitesse	O2	T2S	Indisponibilité	Invalidité	Dép. VLE
Dépassement >4H	0	0	0	0	0	0	0	0	0	0	0	0
Dép. VLE	00:00	19:00	00:00	00:00	00:00	00:00	00:00	01:00	00:00	00:00	00:00	20:00
Nb jour invalides	1	2	1	1	1	1	1	1	1	1	1	2
Indis. Cons >10h	0	0	0	0	0	0	0	0	0	0	0	0
Indisponibilité	08:00	16:30	08:00	08:00	08:00	08:00	08:00	08:00	08:00	08:00	08:00	16:30

 RECYCLAGE ET VALORISATION FRANCE  NOTRE TERRITOIRE A DE L'ENERGIE	BL Infrastructures Direction Valorisation Energétique IDF	APPLICATION : Obligatoire / Recommandé / Informatif
	FICHE D'INCIDENT	DIFFUSION : Confidentiel / Restreint / Interne / Public
		REFERENCE : 09 VLM ENG Fiche d'incident V9 du 24 septembre 2019
		STATUT : Approuvé / En révision / Périmé

FICHE D'INCIDENT N° 19 - 012

Date de l'incident : 24/07/2019 Heure : 10h30 Date d'ouverture de la fiche : 28/10/2019

Destinataires :

DRIEE- IF
ud94.drree-if@developpement-durable.gouv.fr ;
mary-anne.mathieu@developpement-durable.gouv.fr ;
jean-marie.chabane@developpement-durable.gouv.fr ;
xavier.charon@developpement-durable.gouv.fr

Préfecture
pref-environnement@val-de-marne.gouv.fr
 SMITDUVM
kikenl@gpsea.fr ; amvinois@gpsea.fr
 Autre

Secteur de l'usine touché :

EMERAUDE

- Hall de déchargement
- Fosse
- Fours/chaudières
- Traitement fumées / effluent
- Bâtiment administratif
- Tours aéroréfrigérante

DAS

- Hall de déchargement
- Bâtiment administratif
- Manutention
- Four /Chaudières
- Traitement fumés / effluent
- Tour aéroréfrigérante

AUTRE

- Rejet liquide usine
- Voies de circulation
- Environnement usine

Evaluation de la situation :

- Problème d'incendie
- Problème d'analyseur
- Impact sonore
- Impact visuel

- Problème de pollution**
 - Dégagement de fumées
 - Dépassement de seuils polluants
 - Dépassement du seuil en légionelles de 100 000 UFC/l
 - Pollution accidentelle au niveau du stockage des produits
 - Huile Fioul
 - Autres :

Etat de la situation :

- PIOS déclenché Maîtrisé Non maîtrisé En cours de traitement
- Dégât matériel :
- Victime /état :

Origine du problème rencontré :

- Non identifiée Identifiée :

Dépassement du seuil en Mercure (Hg) à 0,129 mg/l pour un seuil à 0,025 mg/l sur les rejets liquides (cf. bulletin d'analyse du rejet nord), dû à un problème de régénération du filtre à charbon sur les effluents de la ligne DAS.

Moyens déjà engagés : Vérification de l'automatisme de décalcification du filtre à charbon. Le résultat suivant prélevé le 28/08 est conforme à 0,0007 mg/l.

Moyens complémentaires à demander : Action préventive : remplacement de la charge de charbon actif programmé semaine 45.

Pièces jointes : Rapports d'analyses « SOCOR » du 08/08/2019 (prélèvement du 24/7) et du 11/09/2019 (prélèvement du 28/8).

Nom, fonction et signature du déclarant :

Marie-Christine VIRATELLE, Directrice de Site

VALO'MARNE
 10/11, rue des Malfourches
 94034 CRETEIL Cedex
 Tél. : 01.48.98.55.11
 Fax : 01.48.98.48.83
 SIRET : 833 921 232 00017





Rapport d'analyse Page 1 / 3
Edité le : 08/08/2019

VALO'MARNE
M. Vincent PERALTA

10/11 rue des Malfourches
94034 CRETEIL

Le rapport établi ne concerne que l'échantillon soumis à l'essai. Il comporte 3 pages.

La reproduction de ce rapport d'analyse n'est autorisée que sous la forme de fac-similé photographique intégral.

Le laboratoire est responsable de toutes les informations fournies dans le rapport, sauf lorsque l'information est fournie par le client. En outre, le laboratoire ne saurait être tenu pour responsable des informations fournies par le client et affectant la validité des résultats.

Dans le cas où le laboratoire n'a pas été chargé de l'étape d'échantillonnage, les résultats s'appliquent à l'échantillon tel qu'il a été reçu.

Les activités de laboratoire sont réalisées au sein de SOCOR à DECHY, hormis les paramètres éventuellement sous-traités qui sont réalisés chez le sous-traitant, dont l'adresse est indiquée sur son rapport d'essais joint

L'accréditation du COFRAC atteste de la compétence des laboratoires pour les seuls essais couverts par l'accréditation, identifiés par le symbole #.

Les paramètres sous-traités sont identifiés par (*).

Identification dossier :	SOC19-8199	Référence contrat :	SOCC11-1033
Identification rapport :	SOC1907-3720 V1	Identification échantillon :	SOC1907-3720
Doc Adm Client :	LF190700036		
Référence client :	rejet Nord		
Nature:	Eau usée		
Prélèvement :	Prélevé le 24/07/2019 à 10h30	Réceptionné le 25/07/2019	
	Prélevé par le client		

Les données concernant la réception, la conservation, le traitement analytique de l'échantillon et les incertitudes de mesure sont disponibles sur demande. Pour déclarer, ou non, la conformité à la spécification, il n'a pas été tenu explicitement compte de l'incertitude associée au résultat.

Date de début d'analyse le 25/07/2019

Paramètres analytiques	Résultats	Unités	Méthodes	Précision	Références de qualité	COFRAC
Analyse sur le produit						
<i>Analyse chimique</i>						
pH	7,3	-	Electrochimie - NF EN 10523	Q		#
Température de mesure du pH	20.8	°C	Electrochimie - NF EN 10523	Q		
Analyses physiques						
Température de l'échantillon à réception	4.6	°C	Thermométrie	NA	8	
Analyses physicochimiques						
<i>Analyses physicochimiques de base</i>						
Demande chimique en oxygène Cl > 2 g/l	875	mg/l O2	Méthode d ajouts dosés	Q		
AOX (méthode SPE) après décantation 2h suivant A.M. du 21/12/2007, annexe 2, §3	272.30	µg/l Cl	Filtration/SPE/Adsorption/Combustion/Coulométrie - NF EN ISO 9562 (Annexe A)	Q		#
Cyanures aisément libérables	< 0.01	mg/l	Flux continu (CFA) - NF EN ISO 14403-2	ND		#
Azote Kjeldahl	22.7	mg/l N	Minéralisation, distillation, titrimétrie - NF EN 25663	Q		#
Demande biochimique en oxygène (DBO) (5 jours)	4	mg/l O2	Avec dilutions et avec ATU - NF EN 1899-1	Q		#
Indice hydrocarbures C10-C40	0.07	mg/l	GC/FID - NF EN ISO 9377-2	Q		#
Conductivité électrique brute à 25°C	23800	µS/cm	Sonde avec correction automatique de la temp. - NF EN 27888	Q		#

SOCOR

Rapport d'analyse Page 2 / 3

Edité le : 08/08/2019

Identification rapport: SOC1907-3720 V1

Destinataire : VALO'MARNE

Doc Adm Client : LF190700036

Paramètres analytiques	Résultats	Unités	Méthodes	Détection	Références de qualité	COFRAC
Matières en suspension totales	22.1	mg/l	Filtration sur Sartorius 1344047Q porosite 1,2µm - NF EN 872	Q		#
Indice Phénol	0.02	mg/l	Flux continu (CFA) - NF EN ISO 14402 - détermination sans extraction après distillation	Q		#
Demande chimique en oxygène	126	mg/l O2	Potentiométrie - NF T90-101	Q		#
Carbone organique total (COT)	7.3	mg/l	COTmètre - NF EN 1484	Q		#
Cyanures totaux (Indice Cyanure)	< 0.01	mg/l	Flux (CFA) - NF EN ISO 14403-2	ND		#
Cr VI (chrome hexavalent)	0.016	mg/l	Spectrophotométrie - NF T90-043	Q		#
Cr III (chrome trivalent)	< 0.005	mg/l	Calcul	ND		#
Formes de l'azote						
Azote nitreux	0.137	mg/l N	Spectrophotométrie - NF EN 26777	Q		#
Azote ammoniacal	19.1	mg/l N	Titrimétrie - NF T90-015-1	Q		#
Azote nitrique	1.98	mg/l N	Chromatographie ionique - NF EN ISO 10304-1	Q		#
Azote total (NTK+NO2-N + NO3-N)	24.68	mg/l N	Calcul	Q		#
Azote oxydé (NO2-N + NO3-N)	2.12	mg/l N	Calcul	Q		#
Cations						
Ammonium	24.5	mg/l NH4	Titrimétrie - NF T90-015-1	Q		#
Anions						
Chlorures	9127	mg/l Cl-	Chromatographie ionique - NF EN ISO 10304-1	Q		#
Sulfates	776.6	mg/l SO4-	Chromatographie ionique - NF EN ISO 10304-1	Q		#
Nitrates	8.760	mg/l NO3-	Chromatographie ionique - NF EN ISO 10304-1	Q		#
Nitrites	0.45	mg/l NO2-	Spectrophotométrie - NF EN 26777	Q		#
Fluorures	11.04	mg/l F-	Chromatographie ionique - NF EN ISO 10304-1	Q		#
Métaux						
Mercure total	129.8	µg/l	SAA Chlorure stanneux - NF EN ISO 12846	Q		#
Minéralisation pour le dosage des métaux totaux	-	-	Digestion acide (acide nitrique) - NF EN ISO 15587-2	NA		#
Aluminium total	0.27	mg/l Al	ICP/AES - NF EN ISO 11885	Q		#
Argent total	< 0.005	mg/l Ag	ICP/AES - NF EN ISO 11885	ND		#
Bore total	1.94	mg/l B	ICP/AES - NF EN ISO 11885	Q		#
Cadmium total	0.001	mg/l Cd	ICP/AES - NF EN ISO 11885	Q		#
Chrome total	0.013	mg/l Cr	ICP/AES - NF EN ISO 11885	Q		#
Cuivre total	< 0.005	mg/l Cu	ICP/AES - NF EN ISO 11885	D		#
Etain total	< 0.005	mg/l Sn	ICP/AES - NF EN ISO 11885	ND		#
Fer total	0.125	mg/l Fe	ICP/AES - NF EN ISO 11885	Q		#
Manganèse total	0.036	mg/l Mn	ICP/AES - NF EN ISO 11885	Q		#
Nickel total	0.006	mg/l Ni	ICP/AES - NF EN ISO 11885	Q		#
Plomb total	0.006	mg/l Pb	ICP/AES - NF EN ISO 11885	Q		#
Thallium total	< 0.05	mg/l Tl	ICP/AES - NF EN ISO 11885	ND		#
Zinc total	0.129	mg/l Zn	ICP/AES - NF EN ISO 11885	Q		#
Arsenic total	< 1	µg/l As	ICP/MS - NF EN ISO 17294-2	D		#
Phosphore total	0.44	mg/l P	ICP/AES - NF EN ISO 11885	Q		#
Analyses écotoxicologiques						
Daphnie CE50 24h (*)	5.5	%	Inhibition de la mobilité - NF EN ISO 6341	NA		#
Teneur en Equitox (A.M. 21/12/2007) (*)	18	/m³	Inhibition de la mobilité - NF EN ISO 6341	NA		#

Détection : Q : Quantifié D : DéTECTÉ ND : Non DÉTECTÉ NA : Non Applicable

SOCOR

Rapport d'analyse Page 3 / 3

Edité le : 08/08/2019

Identification rapport: SOC1907-3720 V1

Destinataire : VALO'MARNE

analyse des anions réalisée sur échantillon congelé

Résultat phosphore non couvert par l'accréditation COFRAC car interférence sur la longueur d'onde validée : 178.222 nm

Ce rapport comprend une annexe d'une page.

DBO - analyse réalisée sur échantillon congelé

AOX : effet matrice écart entre 2 dilutions supérieur à 10% (chap.10.2 de la norme NF EN ISO 9562).

Résultat rendu correspondant à la dilution la plus forte

Sylvain BONNET
Responsable Service

A handwritten signature in black ink, appearing to read 'Sylvain Bonnet', is written over a horizontal line. The signature is stylized and somewhat cursive.



Rapport d'analyse Page 1 / 3
Edité le : 11/09/2019

VALO'MARNE
M. Vincent PERALTA

10/11 rue des Malfourches
94034 CRETEIL

Le rapport établi ne concerne que l'échantillon soumis à l'essai. Il comporte 3 pages.

La reproduction de ce rapport d'analyse n'est autorisée que sous la forme de fac-similé photographique intégral.

Le laboratoire est responsable de toutes les informations fournies dans le rapport, sauf lorsque l'information est fournie par le client. En outre, le laboratoire ne saurait être tenu pour responsable des informations fournies par le client et affectant la validité des résultats.

Dans le cas où le laboratoire n'a pas été chargé de l'étape d'échantillonnage, les résultats s'appliquent à l'échantillon tel qu'il a été reçu.

Les activités de laboratoire sont réalisées au sein de SOCOR à DECHY, hormis les paramètres éventuellement sous-traités qui sont réalisés chez le sous-traitant, dont l'adresse est indiquée sur son rapport d'essais joint

L'accréditation du COFRAC atteste de la compétence des laboratoires pour les seuls essais couverts par l'accréditation, identifiés par le symbole #.

Les paramètres sous-traités sont identifiés par (*).

Identification dossier :	SOC19-9388	Référence contrat :	SOCC11-1033
Identification rapport :	SOC1908-2917 V1	Identification échantillon :	SOC1908-2917
Référence client :	REJET NORD VALO'MARNE		
Nature:	Eau usée		
Prélèvement :	Prélevé le 28/08/2019 à 10h00	Réceptionné le 29/08/2019	
	Prélevé par le client		

Les données concernant la réception, la conservation, le traitement analytique de l'échantillon et les incertitudes de mesure sont disponibles sur demande. Pour déclarer, ou non, la conformité à la spécification, il n'a pas été tenu explicitement compte de l'incertitude associée au résultat.

Date de début d'analyse le 29/08/2019

Paramètres analytiques	Résultats	Unités	Méthodes	Détection	Références de qualité	COFRAC
Analyse sur le produit						
<i>Analyse chimique</i>						
pH	7,3	-	Electrochimie - NF EN 10523	Q		#
Température de mesure du pH	19,7	°C	Electrochimie - NF EN 10523	Q		
Analyses physiques						
Température de l'échantillon à réception	8,0	°C	Thermométrie	NA	#	
Analyses physicochimiques						
<i>Analyses physicochimiques de base</i>						
Demande chimique en oxygène Cl > 2 g/l	936	mg/l O2	Méthode d ajouts dosés	Q		
AOX (méthode SPE) après décantation 2h suivant A.M. du 21/12/2007, annexe 2, §3	65,00	µg/l Cl	Filtration/SPE/Adsorption/Combustion/Coulométrie - NF EN ISO 9562 (Annexe A)	Q		#
Cyanures aisément libérables	< 0,01	mg/l	Flux continu (CFA) - NF EN ISO 14403-2	ND		#
Azote Kjeldahl	6,8	mg/l N	Minéralisation,distillation,titrimétrie - NF EN 25663	Q		#
Demande biochimique en oxygène (DBO) (5 jours)	5	mg/l O2	Avec dilutions et avec ATU - NF EN 1899-1	Q		#
Indice hydrocarbures C10-C40	0,08	mg/l	GC/FID - NF EN ISO 9377-2	Q		#
Conductivité électrique brute à 25°C	25600	µS/cm	Sonde avec correction automatique de la temp. - NF EN 27888	Q		#

SOCOR

Rapport d'analyse Page 2 / 3

Edité le : 11/09/2019

Identification rapport: SOC1908-2917 V1

Destinataire : VALO'MARNE

Paramètres analytiques	Résultats	Unités	Méthodes	Détection	Références de qualité
Matières en suspension totales	< 2.0	mg/l	Filtration sur Sartorius 1344047Q porosite 1,2µm - NF EN 872	ND	#
Indice Phénol	< 0.01	mg/l	Flux continu (CFA) - NF EN ISO 14402 - détermination sans extraction après distillation	ND	#
Demande chimique en oxygène	131	mg/l O2	Potentiométrie - NF T90-101	Q	#
Carbone organique total (COT)	6.2	mg/l	COTmètre - NF EN 1484	Q	#
Cyanures totaux (Indice Cyanure)	< 0.01	mg/l	Flux (CFA) - NF EN ISO 14403-2	ND	#
Cr III (chrome trivalent)	< 0.005	mg/l	Calcul	ND	#
Cr VI (chrome hexavalent) sur eau filtrée à réception	0.014	mg/l	Spectrophotométrie - NF T90-043	Q	#
Formes de l'azote					
Azote nitreux	0.100	mg/l N	Spectrophotométrie - NF EN 26777	Q	#
Azote ammoniacal	1.7	mg/l N	Titrimétrie - NF T90-015-1	Q	#
Azote nitrique	1.81	mg/l N	Chromatographie ionique - NF EN ISO 10304-1	Q	#
Azote total (NTK+NO2-N + NO3-N)	8.61	mg/l N	Calcul	Q	#
Azote oxydé (NO2-N + NO3-N)	1.91	mg/l N	Calcul	Q	#
Cations					
Ammonium	2.2	mg/l NH4	Titrimétrie - NF T90-015-1	Q	#
Anions					
Chlorures	10820.0	mg/l Cl-	Chromatographie ionique - NF EN ISO 10304-1	Q	#
Sulfates	755.10	mg/l SO4-	Chromatographie ionique - NF EN ISO 10304-1	Q	#
Nitrates	8.0	mg/l NO3-	Chromatographie ionique - NF EN ISO 10304-1	Q	#
Nitrites	0.33	mg/l NO2-	Spectrophotométrie - NF EN 26777	Q	#
Fluorures	7.84	mg/l F-	Chromatographie ionique - NF EN ISO 10304-1	Q	#
Métaux					
Mercure total	0.7	µg/l	SAA Chlorure stanneux - NF EN ISO 12846	Q	#
Minéralisation pour le dosage des métaux totaux	-	-	Digestion acide (acide nitrique) - NF EN ISO 15587-2	NA	#
Aluminium total	0.20	mg/l Al	ICP/AES - NF EN ISO 11885	Q	#
Argent total	< 0.005	mg/l Ag	ICP/AES - NF EN ISO 11885	ND	#
Bore total	0.57	mg/l B	ICP/AES - NF EN ISO 11885	Q	#
Cadmium total	< 0.001	mg/l Cd	ICP/AES - NF EN ISO 11885	D	#
Chrome total	0.012	mg/l Cr	ICP/AES - NF EN ISO 11885	Q	#
Cuivre total	< 0.005	mg/l Cu	ICP/AES - NF EN ISO 11885	D	#
Etain total	< 0.005	mg/l Sn	ICP/AES - NF EN ISO 11885	D	#
Fer total	0.123	mg/l Fe	ICP/AES - NF EN ISO 11885	Q	#
Manganèse total	0.010	mg/l Mn	ICP/AES - NF EN ISO 11885	Q	#
Nickel total	< 0.005	mg/l Ni	ICP/AES - NF EN ISO 11885	D	#
Plomb total	0.006	mg/l Pb	ICP/AES - NF EN ISO 11885	Q	#
Thallium total	< 0.05	mg/l Tl	ICP/AES - NF EN ISO 11885	ND	#
Zinc total	0.081	mg/l Zn	ICP/AES - NF EN ISO 11885	Q	#
Arsenic total	< 1	µg/l As	ICP/MS - NF EN ISO 17294-2	D	#
Phosphore total	0.154	mg/l P	ICP/AES - NF EN ISO 11885	Q	#
Analyses écotoxicologiques					
Daphnie CE50 24h (*)	3.7	%	Inhibition de la mobilité - NF EN ISO 6341	NA	#
Teneur en Equitox (A.M. 21/12/2007) (*)	27	/m³	Inhibition de la mobilité - NF EN ISO 6341	NA	#

Détection : Q : Quantifié D : Détecté ND : Non Détecté NA : Non Applicable

SOCOR

Rapport d'analyse Page 3 / 3

Edité le : 11/09/2019

Identification rapport: SOC1908-2917 V1

Destinataire : VALO'MARNE



Ce rapport comprend une annexe d'une page.

Résultat phosphore non couvert par l'accréditation COFRAC car interférence sur la longueur d'onde validée 178.222 nm.

DBO - analyse réalisée sur échantillon congelé

Sylvain BONNET
Responsable Service

A handwritten signature in black ink, appearing to read 'Sylvain Bonnet', is written over a horizontal line. The signature is stylized and somewhat cursive.

 RECICLAGE ET VALORISATION FRANCE  NOUVEAU TERRITOIRE A DE L'ENERGIE	BL Infrastructures Direction Valorisation Energétique IDF	APPLICATION : Obligatoire / Recommandé / Informatif
	FICHE D'INCIDENT	DIFFUSION : Confidentiel / Restreint / Interne / Public
REFERENCE : 09 VLM ENG Fiche d'incident V9 du 24 septembre 2019		
		STATUT : Approuvé / En-révision / Périmé

FICHE D'INCIDENT-N° 19 - 013

Date de l'incident : 25/10/2019 Heure : 00h00 à 24h00 Date d'ouverture de la fiche : 28/10/2019

Destinataires :

DRIEE- IF

ud94.driee-if@developpement-durable.gouv.fr ;
mary-anne.mathieu@developpement-durable.gouv.fr ;
jean-marie.chabane@developpement-durable.gouv.fr ;
xavier.charon@developpement-durable.gouv.fr

Préfecture

pref-environnement@val-de-marne.gouv.fr

SMITDUVM

kikeni@gpsea.fr ; amvinois@gpsea.fr

Autre

Secteur de l'usine touché :

EMERAUDE

- Hall de déchargement
- Fosse
- Fours/chaudières
- Traitement fumées / effluent
- Bâtiment administratif
- Tours aéroréfrigérante

DAS

- Hall de déchargement
- Bâtiment administratif
- Manutention
- Four /Chaudières
- Traitement fumés / effluent
- Tour aéroréfrigérante

AUTRE

- Rejet liquide usine
- Voies de circulation
- Environnement usine

Evaluation de la situation :

- Problème d'incendie
- Problème d'analyseur
- Impact sonore
- Impact visuel

Problème de pollution

- Dégagement de fumées
- Dépassement de seuils polluants
- Dépassement du seuil en légionelles de 100 000 UFC/l
- Pollution accidentelle au niveau du stockage des produits
- Huile Fioul
- Autres :

Etat de la situation :

- PIOS déclenché
- Maîtrisé
- Non maîtrisé
- En cours de traitement
- Dégât matériel :
- Victime /état :

Origine du problème rencontré :

- Non identifiée
- Identifiée :

Dépassement de la moyenne journalière en HCl de la ligne DAS à 10,13 mg/Nm3 (pour un seuil à 10 mg/Nm3), suite au bouchage de la tuyauterie d'injection de chaux éteinte au niveau du filtre à manches.

Moyens déjà engagés : Débouchage régulier de la tuyauterie d'injection de chaux éteinte

Moyens complémentaires à demander : Retour à la qualité de chaux habituellement commandée (stock de nouveau disponible).

Pièces jointes :

Rapport journalier d'auto surveillance du 25/10/2019

Nom, fonction et signature du déclarant :



VALO'MARNE - Christine VIRATELLE, Directrice de Site
 10/11, rue des Malfourches
 94034 CRETEIL Cedex
 Tél. : 01.48.98.55.11
 Fax : 01.48.98.48.83
 SIRET : 833 921 232 00017



Rapport DREAL Journalier Ligne 4

Rapport journalier														25 Octobre 2019	
Mesure IC95 Ligne4															
Unité	CO mg/Nm3	COT mg/Nm3	HCL mg/Nm3	NH3 mg/Nm3	NOX mg/Nm3	POUSSIÈRE mg/Nm3	SO2 mg/Nm3	Vitesse30_T4_2C m/s	O2 %	T28_30_L4 degreC	MarchePointA_30 hh:mm:ss	Tournege DASRI Tonne			
VLE 1/2h	100	20	40	20	10	30	100								
VLE max	100	20	40	20	10	150	100								
Seuil Min.	50	10	10	10	10	10	50		12	850					
VLE Jour	50	10	10	10	10	100	10	50		850					
00:30	4.04	0.00	7.89	2.05	71.45	0.289	2.29	16.13	10.07	961.4	00:30:00	0.0			
01:00	2.61	0.00	8.87	1.81	63.23	0.263	2.18	16.09	9.52	985.4	00:30:00	0.0			
01:30	2.08	0.00	11.41	1.89	78.21	0.277	2.48	19.33	9.43	1009.3	00:30:00	0.0			
02:00	2.39	0.00	12.44	1.73	72.14	0.265	2.16	17.78	9.62	1012.5	00:30:00	0.0			
02:30	2.97	0.00	10.18	1.65	56.52	0.265	1.69	15.95	9.48	994.8	00:30:00	0.0			
03:00	2.40	0.00	11.09	1.56	63.04	0.274	1.74	16.25	9.35	1002.1	00:30:00	0.0			
03:30	2.87	0.00	10.31	1.58	61.52	0.270	1.27	16.06	9.47	994.1	00:30:00	0.0			
04:00	3.50	0.00	9.16	1.62	61.59	0.269	0.97	16.04	9.44	1001.2	00:30:00	0.0			
04:30	2.52	0.00	8.78	1.37	49.60	0.271	1.05	14.25	9.55	984.6	00:30:00	0.0			
05:00	2.80	0.00	9.14	1.39	56.47	0.288	1.21	15.67	9.67	968.7	00:30:00	0.0			
05:30	2.18	0.00	9.69	1.73	77.47	0.280	1.25	21.35	9.38	1000.9	00:30:00	0.0			
06:00	2.70	0.00	11.32	1.88	96.64	0.287	1.88	17.56	9.38	994.4	00:30:00	0.0			
06:30	1.45	0.00	12.72	1.66	94.22	0.287	2.35	17.58	9.27	1024.7	00:30:00	0.0			
07:00	1.90	0.00	11.19	1.38	30.20	0.286	2.49	16.14	9.42	999.2	00:30:00	0.0			
07:30	2.11	0.00	11.46	1.22	56.33	0.282	2.18	16.90	9.47	996.5	00:30:00	0.0			
08:00	2.15	0.00	9.70	1.12	67.60	0.273	1.60	15.60	9.50	987.0	00:30:00	0.0			
08:30	2.07	0.00	9.64	1.20	72.77	0.276	1.80	16.48	9.72	992.4	00:30:00	0.0			
09:00	1.84	0.00	10.16	1.06	79.16	0.277	1.99	16.34	9.49	1012.8	00:30:00	0.0			
09:30	1.53	0.00	12.46	1.09	67.93	0.284	2.10	18.78	9.45	1025.1	00:30:00	0.0			
10:00	1.33	0.00	10.87	1.17	55.12	0.269	1.95	17.58	9.58	1016.4	00:30:00	0.0			
10:30	2.32	0.00	11.17	1.22	55.12	0.269	2.13	18.03	9.53	1001.3	00:30:00	0.0			
11:00	2.33	0.00	12.66	1.21	61.63	0.282	2.07	18.26	9.52	1005.5	00:30:00	0.0			
11:30	2.41	0.00	16.36	1.26	56.79	0.284	2.42	18.43	9.32	1003.3	00:30:00	0.0			
12:00	2.33	0.00	18.11	1.20	60.50	0.286	2.19	17.60	9.62	990.6	00:30:00	0.0			
12:30	2.64	0.00	16.79	1.25	65.31	0.279	2.48	17.82	9.65	987.2	00:30:00	0.0			
13:00	2.76	0.00	13.67	1.41	48.74	0.277	1.98	15.16	10.00	974.7	00:20:10	0.0			
13:30	5.91	0.00	8.28	1.17	62.57	0.285	1.67	15.52	10.63	949.3	00:24:30	0.0			
14:00	2.41	0.00	8.86	0.87	56.59	0.264	0.97	14.49	9.76	955.1	00:30:00	0.0			
14:30	3.31	0.00	7.95	0.95	59.84	0.293	1.56	14.94	10.26	947.3	00:30:00	0.0			
15:00	2.90	0.00	8.30	0.96	60.37	0.290	1.75	14.84	10.03	946.2	00:30:00	0.0			
15:30	2.73	0.00	9.12	1.05	72.78	0.271	1.96	17.13	9.57	959.2	00:30:00	0.0			
16:00	2.81	0.00	8.20	1.24	60.92	0.262	1.84	17.97	9.48	979.8	00:30:00	0.0			
16:30	2.25	0.00	6.84	1.28	55.89	0.254	1.06	15.26	9.44	979.7	00:30:00	0.0			
17:00	2.31	0.00	7.43	1.23	33.66	0.263	0.68	15.29	9.79	972.1	00:30:00	0.0			
17:30	2.05	0.00	7.33	1.22	63.57	0.264	0.56	16.05	9.54	953.7	00:30:00	0.0			
18:00	2.49	0.00	8.72	1.41	75.27	0.283	0.86	21.42	9.37	989.3	00:30:00	0.0			
18:30	1.68	0.00	11.21	1.59	81.24	0.308	1.45	21.79	9.29	1024.4	00:30:00	0.0			
19:00	2.86	0.00	9.73	1.33	43.10	0.290	1.53	17.97	9.61	990.1	00:30:00	0.0			
19:30	2.91	0.00	8.84	1.34	58.42	0.280	1.26	17.61	9.46	996.8	00:30:00	0.0			
20:00	2.89	0.00	8.41	1.48	68.78	0.272	1.44	18.15	9.55	984.2	00:30:00	0.0			
20:30	2.50	0.00	8.08	1.39	59.87	0.265	1.80	17.10	9.48	992.1	00:30:00	0.0			
21:00	2.23	0.00	11.48	1.22	72.82	0.268	2.50	18.19	9.46	997.5	00:30:00	0.0			
21:30	3.51	0.00	11.89	1.21	59.92	0.270	2.89	17.17	9.43	997.8	00:30:00	0.0			
22:00	4.53	0.00	8.48	1.50	71.67	0.366	2.40	20.33	9.83	1008.2	00:30:00	0.0			
22:30	3.79	0.00	8.84	1.74	67.91	0.286	2.26	19.51	9.39	997.3	00:30:00	0.0			
23:00	3.06	0.00	7.31	1.52	80.79	0.276	2.36	18.10	9.53	1011.6	00:28:30	0.0			
23:30	2.40	0.01	5.43	1.16	51.87	0.269	2.21	13.88	10.03	964.1	00:13:00	0.0			
00:00	2.40	0.01	5.43	1.16	51.87	0.269	2.21	13.88	10.03	964.1	00:22:00	0.0			
Max.	5.91	0.02	18.11	2.05	94.22	0.366	2.99	21.79	10.63	1025.1		0.0			
Min.	1.45	0.00	5.43	0.87	43.10	0.254	0.56	13.88	9.27	946.2		0.0			
Moy/Cumul	2.62	0.00	10.13	1.39	63.71	0.279	1.79	17.18	9.59	989.8	23:18:10	0.0			
Dép. VLE 1/2h	0	0	0	0	0	0	0	0	0	0	0	0.0			
Dép. VLE max	00:00	00:00	0	0	0	0	0	0	0	0	0	0.0			
Dép. Seuil Min.	0	0	0	0	0	0	0	0	0	0	0	0.0			
InDisponibilite	0	0	0	0	0	0	0	0	0	0	0	0.0			
% données EG	0.00	0.00	0.00	0.00	0.00	0.00	0.00	0.00	0.00	0.00	0.00	0.00			
Invalides	0	0	0	0	0	0	0	0	0	0	0	0.0			
Dép. VLE Jour	0	0	1	0	0	0	0	0	0	0	0	0.0			

Généralisation de l'absence							
Département >4h	Dép. VLE	Nb jour invalides	Incls. Cons >10h	InDisponibilité	Invalides	Dép. VLE Jour	
0	0	1	0	0	0	0	
0	0	2	0	0	0	0	
0	0	1	0	0	0	0	
0	0	1	0	0	0	0	

 RECYCLAGE ET VALORISATION FRANCE  NOIRE TERRITOIRE A DE L'ENERGIE	BL Infrastructures Direction Valorisation Energétique IDF	APPLICATION : Obligatoire / Recommandé / Informatif
	FICHE D'INCIDENT	DIFFUSION : Confidentiel / Restreint / Interne / Public
		REFERENCE : 09 VLM ENG Fiche d'incident V9 du 24 septembre 2019
		STATUT : Approuvé / En révision / Périmé

FICHE D'INCIDENT N° 19 - 014

Date de l'incident : 01/11/2019 Heure : 00h00 à 24h00 Date d'ouverture de la fiche : 04/11/2019

Destinataires :

DRIEE- IF
ud94.driee-if@developpement-durable.gouv.fr ;
mary-anne.mathieu@developpement-durable.gouv.fr ;
jean-marie.chabane@developpement-durable.gouv.fr ;
xavier.charon@developpement-durable.gouv.fr

Préfecture
pref-environnement@val-de-marne.gouv.fr
 SMITDUVM
kiken@gpsea.fr ; amvinois@gpsea.fr
 Autre

Secteur de l'usine touché :

EMERAUDE

- Hall de déchargement
- Fosse
- Fours/chaudières
- Traitement fumées / effluent
- Bâtiment administratif
- Tours aэрорéfrigérante

DAS

- Hall de déchargement
- Bâtiment administratif
- Manutention
- Four /Chaudières
- Traitement fumées / effluent
- Tour aэрорéfrigérante

AUTRE

- Rejet liquide usine
- Voies de circulation
- Environnement usine

Evaluation de la situation :

- Problème d'incendie
- Problème d'analyseur
- Impact sonore
- Impact visuel

- Problème de pollution
 - Dégagement de fumées
 - Dépassement de seuils polluants
 - Dépassement du seuil en légionelles de 100 000 UFC/l
 - Pollution accidentelle au niveau du stockage des produits
 - Huile Fioul
 - Autres :

Etat de la situation :

- Maîtrisé Non maîtrisé En cours de traitement
- PIOS déclenché Dégât matériel : Victime /état :

Origine du problème rencontré :

- Non identifiée Identifiée :

Dépassement de la moyenne journalière en HCl de la ligne DAS à 10,55 mg/Nm3 (pour un seuil à 10 mg/Nm3), suite à nouveau bouchage de l'injection de chaux.

Moyens déjà engagés : Automatisation du percuteur au niveau de la trémie du Skid d'injection de chaux éteinte afin d'éviter les bouchages de la tuyauterie (réalisation effectuée par le service maintenance).

Moyens complémentaires à demander : Surveillance renforcée.

Pièces jointes :

Rapport journalier d'auto surveillance du 01/11/2019

Nom, fonction et signature du déclarant :

VALO'MARNE
 10/11, rue des Malfourches
 94034 CRETEIL Cedex
 Tél. : 01.48.98.55.11
 Fax : 01.48.98.48.83
 SIRET : 833 921 232 00017

Marie-Christine VIRATELLE, Directrice de Site







Rapport DREAL Journalier Ligne 4

Rapport journalier												01 Novembre 2010		
Mairie IC95 Lignol														
Unité	CO mg/Nm3	COT mg/Nm3	HCL mg/Nm3	NH3 mg/Nm3	NOX mg/Nm3	POUSSIERE mg/Nm3	SO2 mg/Nm3	Vitesse30_T4_2C m/s	O2 %	T28_30_L4 degreC	MarcheFourL4_J0 hh:mm:ss	Tonnage DASRI Tonne		
VLE 1/2h	100	100	20	60	20	100	10	200	12		850			
VLE max														
Seuil Min.														
VLE Jour	50	10	10	10	100	10	50							
00:30	3.14	0.00	13.92	1.76	65.24	0.264	2.51	20.14	9.46	1007.4	00:30:00	0.0		
01:00	3.64	0.00	11.96	1.88	62.64	0.263	2.30	19.93	9.49	1003.3	00:30:00	0.0		
01:30	4.30	0.00	12.27	1.90	56.38	0.274	4.17	21.16	9.35	992.5	00:30:00	0.0		
02:00	3.40	0.00	10.34	2.28	69.05	0.283	1.99	22.35	9.36	1002.9	00:30:00	0.0		
02:30	3.97	0.00	10.05	2.58	57.89	0.281	2.28	20.95	9.48	983.6	00:30:00	0.0		
03:00	3.07	0.00	13.86	2.34	65.10	0.284	2.45	20.89	9.32	987.3	00:30:00	0.0		
03:30	3.66	0.00	14.11	2.17	61.77	0.290	4.48	19.27	9.47	994.2	00:30:00	0.0		
04:00	2.96	0.00	13.70	2.07	65.60	0.291	3.06	21.02	9.70	1013.8	00:30:00	0.0		
04:30	2.64	0.00	14.18	2.04	72.62	0.291	2.80	22.64	9.35	1013.7	00:30:00	0.0		
05:00	3.26	0.00	14.77	2.38	44.46	0.290	2.82	20.43	10.19	990.3	00:30:00	0.0		
05:30	4.14	0.00	11.70	2.36	37.78	0.281	1.81	20.19	9.77	988.7	00:30:00	0.0		
06:00	2.59	0.00	8.85	2.26	65.51	0.278	1.31	20.89	9.39	992.1	00:30:00	0.0		
06:30	2.87	0.00	8.82	2.41	73.76	0.273	1.19	19.59	9.29	999.0	00:30:00	0.0		
07:00	2.02	0.00	8.05	1.91	65.01	0.270	1.34	19.59	9.25	1002.9	00:30:00	0.0		
07:30	2.03	0.00	9.35	1.68	63.90	0.274	1.51	19.73	9.43	1003.0	00:30:00	0.0		
08:00	2.21	0.00	9.29	1.54	60.58	0.276	1.64	19.77	9.35	1001.8	00:30:00	0.0		
08:30	2.47	0.00	8.76	1.50	37.28	0.270	1.33	18.36	9.33	996.3	00:30:00	0.0		
09:00	1.99	0.00	8.77	1.41	56.81	0.265	1.29	17.32	9.28	988.9	00:30:00	0.0		
09:30	2.15	0.00	9.55	1.34	33.89	0.256	1.17	17.68	9.32	979.0	00:30:00	0.0		
10:00	2.76	0.00	10.72	1.33	62.96	0.255	0.98	18.93	9.24	971.6	00:30:00	0.0		
10:30	3.65	0.00	12.71	1.46	66.34	0.257	1.06	19.03	9.29	982.5	00:30:00	0.0		
11:00	5.02	0.00	12.88	1.43	62.77	0.267	0.93	19.28	9.21	971.4	00:30:00	0.0		
11:30	3.87	0.00	14.72	1.39	61.29	0.263	1.38	18.46	9.37	984.2	00:30:00	0.0		
12:00	4.83	0.00	15.34	1.32	38.37	0.278	1.71	17.18	9.39	983.9	00:30:00	0.0		
12:30	2.66	0.00	22.71	1.19	80.39	15.051	1.50	17.24	9.29	991.3	00:30:00	0.0		
13:00	Arrêt	Arrêt	Arrêt	Arrêt	Arrêt	Arrêt	Arrêt	Arrêt	Arrêt	Arrêt	00:16:10	0.0		
13:30	Arrêt	Arrêt	Arrêt	Arrêt	Arrêt	Arrêt	Arrêt	Arrêt	Arrêt	Arrêt	00:00:00	0.0		
14:00	Arrêt	Arrêt	Arrêt	Arrêt	Arrêt	Arrêt	Arrêt	Arrêt	Arrêt	Arrêt	00:03:10	0.0		
14:30	44.60	0.09	5.37	1.08	42.06	0.362	0.76	14.17	10.43	941.3	00:30:00	0.0		
15:00	15.74	0.04	5.30	1.36	35.67	0.304	0.74	14.77	9.67	934.7	00:30:00	0.0		
15:30	3.49	0.00	8.68	1.41	47.24	0.291	0.58	15.14	9.19	963.5	00:30:00	0.0		
16:00	3.31	0.00	11.34	1.46	66.01	0.285	0.79	15.39	9.23	957.8	00:30:00	0.0		
16:30	3.47	0.00	12.95	1.39	65.57	0.260	1.10	15.36	9.25	955.7	00:30:00	0.0		
17:00	3.11	0.00	13.34	1.46	68.52	0.259	1.41	17.03	9.08	971.1	00:30:00	0.0		
17:30	3.66	0.00	11.30	1.90	65.21	0.259	1.72	16.53	9.48	954.7	00:30:00	0.0		
18:00	7.05	0.07	10.36	1.94	65.97	0.297	1.23	17.04	9.57	952.6	00:30:00	0.0		
18:30	7.81	0.16	11.07	1.91	63.52	0.304	1.07	16.97	9.80	930.5	00:30:00	0.0		
19:00	4.83	0.16	10.10	2.00	66.02	0.287	1.03	17.70	9.51	954.5	00:30:00	0.0		
19:30	3.29	0.10	11.75	1.86	70.53	0.270	1.00	16.78	9.32	961.4	00:30:00	0.0		
20:00	3.78	0.09	8.22	1.96	69.57	0.280	0.89	18.11	9.18	972.7	00:30:00	0.0		
20:30	3.72	0.22	7.17	2.23	63.60	0.293	0.80	18.36	9.23	987.1	00:30:00	0.0		
21:00	2.90	0.16	7.10	1.78	63.04	0.258	0.72	17.41	9.02	988.0	00:30:00	0.0		
21:30	2.92	0.11	7.18	1.63	58.12	0.264	0.75	17.95	9.17	982.0	00:30:00	0.0		
22:00	4.20	0.09	6.36	1.78	59.96	0.260	0.82	17.42	9.25	978.8	00:30:00	0.0		
22:30	3.89	0.18	7.47	1.85	63.84	0.266	1.07	17.26	9.30	980.0	00:30:00	0.0		
23:00	6.66	0.23	6.58	1.75	54.48	0.287	1.22	16.44	9.36	959.1	00:30:00	0.0		
23:30	6.66	0.23	6.58	1.75	63.07	0.286	1.20	17.83	9.79	949.5	00:30:00	0.0		
00:00	7.12	0.36	6.17	1.71	68.19	0.297	1.32	18.10	9.59	953.1	00:30:00	0.0		
Max.	44.60	0.36	22.71	2.58	80.39	15.051	3.06	21.54	10.43	1013.8		6.0		
Min.	1.99	0.00	8.30	1.08	35.67	0.256	0.58	14.17	9.05	941.3		0.0		
Moy/Comal	4.92	0.05	10.25	1.78	62.88	0.268	1.44	18.39	9.42	979.9	23:49:20	0.0		
Dép. VLE 1/2h	0	0	0	0	0	0	0	0	0	0	0	0	0	
Dép. VLE max	00:00	00:00												
Dép. Seuil Min.														
Indisponibilité	0	0	0	0	0	0	0	0	0	0	0	0	0	
% données EG	0.00	0.00	0.00	0.00	0.00	0.00	0.00	0.00	0.00	0.00	0	0	0	
Invalité	0	0	0	0	0	0	0	0	0	0	0	0	0	
Dép. VLE Jour	0	0	1	0	0	0	0	0	0	0	0	0	0	

Code	Description	CO	HCL	NH3	NOX	POUSSIERE	SO2	Vitesse	O2	T28_30	Marche	Tonnage
Dépassement >4H		0	0	0	0	0	0	0	0	0	0	0
Dép. VLE		00:00	19:30	00:00	00:00	00:00	00:00	01:00	0	0	0	0
Nb jour invalide		1	2	1	1	1	1	1	1	00:00	0	20:00
Indis. Com >10h		0	0	0	0	0	0	0	0	0	0	0
Indisponibilité		08:00	16:30	08:00	08:00	08:00	08:00	08:00	08:00	08:00	08:00	16:30

 <small>RECYCLAGE ET VALORISATION FRANCE</small>  <small>MUTUAL TERRITORIAL A DE L'ENERGIE</small>	BL Infrastructures Direction Valorisation Energétique IDF	APPLICATION : Obligatoire / Recommandé / Informatif
	FICHE D'INCIDENT	DIFFUSION : Confidentiel / Restreint / Interne / Public
		REFERENCE : 09 VLM ENG Fiche d'incident V9 du 24 septembre 2019
		STATUT : Approuvé / En révision / Périmé

FICHE D'INCIDENT N° 19 - 015

Date de l'incident : 05/11/2019 Heure : 00h00 à 24h00 Date d'ouverture de la fiche : 08/11/2019

Destinataires :

DRIEE- IF
ud94.drlee-if@developpement-durable.gouv.fr ;
mary-anne.mathieu@developpement-durable.gouv.fr ;
jean-marle.chabane@developpement-durable.gouv.fr ;
xavier.charon@developpement-durable.gouv.fr

Préfecture
pref-environnement@val-de-marne.gouv.fr
 SMITDUVM
kikeni@gpsea.fr ; amvinois@gpsea.fr
 Autre

Secteur de l'usine touché :

- EMERAUDE**
- Hall de déchargement
 - Fosse
 - Fours/chaudières
 - Traitement fumées / effluent
 - Bâtiment administratif
 - Tours aéroréfrigérante

- DAS**
- Hall de déchargement
 - Bâtiment administratif
 - Manutention
 - Four /Chaudières
 - Traitement fumés / effluent
 - Tour aéroréfrigérante

- AUTRE**
- Rejet liquide usine
 - Voies de circulation
 - Environnement usine

Evaluation de la situation :

- Problème d'incendie
- Problème d'analyseur
- Impact sonore
- Impact visuel

- Problème de pollution**
 - Dégageement de fumées
 - Dépassement de seuils polluants
 - Dépassement du seuil en légionelles de 100 000 UFC/l
 - Pollution accidentelle au niveau du stockage des produits
 - Huile Fioul
 - Autres :

Etat de la situation :

- PIOS déclenché Maîtrisé Non maîtrisé En cours de traitement
- Dégât matériel : Victime /état :

Origine du problème rencontré :

- Non identifiée Identifiée :

Dépassement de la moyenne journalière en HCl de la ligne DAS à 11,46 mg/Nm3 (pour un seuil à 10 mg/Nm3), suspicion de fuite sur l'échangeur Fumées/Fumées (pas de bouchage chaux constaté).
Moyens déjà engagés : Automatisation du percuteur au niveau de la trémie du Skid d'injection de chaux éteinte afin d'éviter les bouchages de la tuyauterie (réalisation effectuée par le service maintenance). Baisse de la consigne d'enfournement de 2,0 t/h à 1,6 t/h.
Moyens complémentaires à demander : Décision d'arrêt de la ligne DAS ce week-end du 10/11, refroidissement de la ligne et inspection complète du 12/11 au 13/11 du traitement de fumées, étanchéité échangeur F/F, filtre à manche et injection de chaux.
Pièces jointes :
 Rapport journalier d'auto surveillance du 05/11/2019



Nom, fonction et signature du déclarant :
Marie-Christine VIRATELLE, Directrice de Site



Rapport DREAL Journalier Ligne 4

Rapport journalier													
Mesure IC95 Ligne 4													
Unité	CO	COT	HCL	NH3	NOX	POUSSIÈRE	SO2	Vitesse	O2	T25_30_L4	Marche	Four	Tonnage
VLE 1/2h	mg/Nm3	mg/Nm3	mg/Nm3	mg/Nm3	mg/Nm3	mg/Nm3	mg/Nm3	m/s	%	degréC	h:min:mas	L4_30	DASRI
VLE max	100	20	60	20	100	30	300	12	880				
Seuil Min.	100	20	60	20	100	150	300	12	880				
VLE Jour	50	10	10	10	100	10	50						
00:30	33.41	0.01	1.58	1.28	52.31	0.345	2.13	14.06	11.56	918.7	00:30:00		0.0
01:00	27.08	0.00	1.78	1.39	71.34	0.285	1.69	17.11	9.56	990.6	00:30:00		0.0
01:30	3.34	0.00	2.17	1.37	54.61	0.269	1.76	15.21	9.28	965.3	00:30:00		0.0
02:00	3.25	0.00	2.64	1.67	59.49	0.273	1.77	15.10	9.48	964.7	00:30:00		0.0
02:30	3.26	0.00	3.42	1.79	61.16	0.275	2.16	16.94	9.39	969.7	00:30:00		0.0
03:00	3.68	0.00	4.61	1.64	63.74	0.277	2.29	16.93	9.16	969.9	00:30:00		0.0
03:30	3.45	0.00	5.76	1.53	58.38	0.267	2.48	16.08	9.07	965.5	00:30:00		0.0
04:00	2.92	0.00	6.90	1.42	71.80	0.277	2.33	15.73	9.21	968.9	00:30:00		0.0
04:30	3.39	0.00	6.44	1.38	35.29	0.273	2.34	15.17	9.38	954.7	00:30:00		0.0
05:00	3.68	0.00	6.01	1.42	72.92	0.276	2.41	15.86	9.33	948.3	00:30:00		0.0
05:30	4.57	0.00	6.96	1.13	53.16	0.293	1.25	15.72	9.66	943.8	00:30:00		0.0
06:00	6.44	0.00	8.79	1.24	67.74	0.303	1.17	16.73	10.07	945.3	00:30:00		0.0
06:30	6.33	0.00	7.01	1.33	70.92	0.303	0.98	16.28	9.58	962.9	00:30:00		0.0
07:00	3.15	0.00	6.39	1.22	32.36	0.288	1.36	14.84	9.32	954.1	00:30:00		0.0
07:30	4.84	0.00	7.51	1.06	65.34	0.281	1.52	15.71	9.55	948.8	00:30:00		0.0
08:00	0.14	0.00	11.18	0.99	66.01	0.300	2.01	16.18	10.08	947.5	00:30:00		0.0
08:30	23.03	0.41	12.04	0.88	63.36	0.298	2.35	15.83	9.91	952.5	00:30:00		0.0
09:00	Arrêt	Arrêt	Arrêt	Arrêt	Arrêt	Arrêt	Arrêt	Arrêt	Arrêt	Arrêt	00:00:00		0.0
09:30	23.94	0.00	7.27	0.81	58.90	0.343	1.12	13.98	11.48	916.0	00:26:30		0.0
10:00	26.86	0.00	9.65	0.75	71.58	0.295	1.09	15.38	9.28	945.4	00:30:00		0.0
10:30	3.07	0.00	10.64	0.73	73.04	0.268	1.14	14.63	9.14	972.2	00:30:00		0.0
11:00	2.53	0.00	11.74	0.70	67.50	0.263	1.73	14.88	9.11	972.2	00:30:00		0.0
11:30	2.10	0.00	11.57	0.71	63.67	0.262	1.67	15.66	9.05	985.3	00:30:00		0.0
12:00	3.45	0.00	11.30	0.79	62.48	0.273	1.14	15.32	9.14	985.4	00:30:00		0.0
12:30	2.04	0.00	10.38	0.84	50.18	0.258	0.92	14.67	9.34	962.7	00:30:00		0.0
13:00	2.38	0.00	10.91	0.81	74.60	0.250	1.07	15.18	9.24	973.0	00:30:00		0.0
13:30	1.77	0.00	12.76	0.81	71.86	0.255	0.82	15.30	9.18	992.9	00:30:00		0.0
14:00	1.84	0.00	12.43	0.84	59.92	0.246	1.03	14.86	9.03	990.9	00:30:00		0.0
14:30	1.75	0.00	7.76	1.07	66.96	0.248	0.42	15.50	9.22	985.6	00:30:00		0.0
15:00	1.66	0.00	7.50	1.04	62.49	0.244	0.38	15.70	9.14	996.2	00:30:00		0.0
15:30	2.10	0.00	8.30	0.69	47.73	0.243	0.37	14.33	9.11	979.4	00:30:00		0.0
16:00	27.68	0.21	9.04	0.54	50.71	0.268	0.41	13.94	10.14	945.5	00:27:40		0.0
16:30	8.00	0.00	11.61	0.32	65.81	0.265	0.42	14.95	10.16	945.9	00:30:00		0.0
17:00	6.02	0.00	10.71	0.23	68.34	0.251	0.42	14.54	8.99	968.8	00:30:00		0.0
17:30	6.30	0.00	9.54	0.95	61.46	0.251	1.90	14.86	9.09	968.6	00:30:00		0.0
18:00	3.73	0.00	11.84	0.73	60.62	0.259	2.17	15.03	8.97	981.4	00:30:00		0.0
18:30	4.36	0.00	10.11	0.81	69.88	0.245	2.22	15.11	8.91	993.5	00:30:00		0.0
19:00	3.02	0.00	14.43	0.74	68.47	0.251	2.97	15.87	9.11	1002.7	00:30:00		0.0
19:30	3.62	0.00	19.47	0.70	52.12	0.271	3.71	14.46	9.06	977.8	00:30:00		0.0
20:00	1.81	0.00	18.20	0.76	70.59	0.270	3.36	15.18	8.88	992.0	00:30:00		0.0
20:30	1.49	0.00	20.19	0.76	78.55	0.270	3.45	16.06	9.12	1000.7	00:30:00		0.0
21:00	3.12	0.00	22.04	0.97	51.58	0.275	3.24	15.00	9.47	980.4	00:30:00		0.0
21:30	2.46	0.00	32.80	0.95	65.90	0.272	3.49	15.17	9.04	994.9	00:30:00		0.0
22:00	2.40	0.00	41.99	1.24	77.61	0.280	3.56	16.75	9.26	1006.2	00:30:00		0.0
22:30	2.46	0.00	31.45	1.27	74.93	0.276	2.84	15.61	9.19	1009.7	00:30:00		0.0
23:00	6.56	0.00	17.47	1.09	40.16	0.265	2.20	13.21	9.02	975.0	00:27:00		0.0
23:30	1.63	0.00	14.85	1.17	72.08	0.352	3.03	12.78	12.11	971.6	00:28:00		0.0
00:00	1.69	0.00	9.59	1.08	87.84	0.364	3.33	12.28	12.52	980.6	00:24:40		0.0
Max.	33.41	0.41	41.99	1.79	87.84	0.564	3.71	17.11	12.52	1009.7			0.0
Min.	1.49	0.00	1.68	0.23	40.16	0.243	0.37	12.28	8.88	916.0			0.0
Moy/Cumul	6.83	0.01	11.46	1.02	64.87	0.277	1.88	16.23	9.86	970.7	13(12)10		0.0
Dép. VLE 1/2h	0	0	0	0	0	0	0	0	0	0			0
Dép. VLE max	00:00	00:00	0	0	0	0	0	00:00	0	00:00			0
Dép. Seuil Min.	0	0	0	0	0	0	0	0	0	0			0
Indisponibilité	0	0	0	0	0	0	0	0	0	0			0
% données HQ	0.00	0.00	0.00	0.00	0.00	0.000	0.00	0.00	0.00	0.0			0.0
Invalidité	0	0	0	0	0	0	0	0	0	0			0
Dép. VLE Jour	0	0	1	0	0	0	0	0	0	0			0

Général (Moyennes journalières)													
Dépassement >VLE													
Dépassement >VLE													
Nb jour invalides													
Indisponibilité													
Dépassement >VLE	0	0	0	0	0	0	0	0	0	0	0	0	0
Dép. VLE	00:00	00:00	21:30	00:00	00:00	00:00	00:00	00:00	00:00	01:00	00:00	00:00	21:30
Nb jour invalides	1	2	1	1	1	1	1	1	1	1	1	1	2
Indisponibilité	08:00	0	0	08:00	08:00	08:00	08:00	08:00	08:00	08:00	08:00	08:00	16:30

 RECYCLAGE ET VALORISATION FRANCE  HOTEL TERRITOIRE A DE L'ENERGIE	BL Infrastructures Direction Valorisation Energétique IDF	APPLICATION : Obligatoire / Recommandé / Informatif
	FICHE D'INCIDENT	DIFFUSION : Confidentiel / Restreint / Interne / Public
		REFERENCE : 09 VLM ENG Fiche d'incident V9 du 24 septembre 2019
		STATUT : Approuvé / En révision / Périmé

FICHE D'INCIDENT N° 19 - 016

Date de l'incident : 15/12/2019 Heure : 00h00 à 24h00 Date d'ouverture de la fiche : 16/12/2019

Destinataires :

DRIEE- IF
ud94.drlee-if@developpement-durable.gouv.fr ;
mary-anne.mathieu@developpement-durable.gouv.fr ;
jean-marie.chabane@developpement-durable.gouv.fr ;
xavier.charon@developpement-durable.gouv.fr

Préfecture
pref-environnement@val-de-marne.gouv.fr
 SMITDUVM
kikeni@gpsea.fr ; amvinois@gpsea.fr
 Autre

Secteur de l'usine touché :

EMERAUDE

- Hall de déchargement
- Fosse
- Fours/chaudières
- Traitement fumées / effluent
- Bâtiment administratif
- Tours aérorefrigérante

DAS

- Hall de déchargement
- Bâtiment administratif
- Manutention
- Four /Chaudières
- Traitement fumés / effluent
- Tour aérorefrigérante

AUTRE

- Rejet liquide usine
- Voies de circulation
- Environnement usine

Evaluation de la situation :

- Problème d'incendie
- Problème d'analyseur
- Impact sonore
- Impact visuel
- Problème de pollution
 - Dégagement de fumées
 - Dépassement de seuils polluants
 - Dépassement du seuil en légionelles de 100 000 UFC/l
 - Pollution accidentelle au niveau du stockage des produits
 - Huile Fioul
 - Autres :

Etat de la situation :

- PIOS déclenché
- Maîtrisé
- Non maîtrisé
- En cours de traitement
- Dégât matériel :
- Victime /état :

Origine du problème rencontré :

- Non identifiée
- Identifiée :

Dépassement de la valeur flux jour en NOx sur la ligne 2 à 154.264 Kg (pour un seuil à 153,6 Kg).

Moyens déjà engagés : Modification de la consigne de régulation (NOx : -10 mg/Nm3).

Moyens complémentaires à demander :

Pièces jointes :

Rapport journalier d'auto surveillance du 15/12/2019

Nom, fonction et signature du déclarant :

Marie-Christine VIRATELLE, Directrice de Site

VALO'MARNE
 10/11, rue des Malfourches
 94034 CRETEIL Cedex
 Tél. : 01.48.98.55.11
 Fax : 01.48.98.48.83
 SIRET : 833 921 232 00017



Rapport DREAL Flux Journalier Ligne 2

Rapport Flux Journalier										15 Decembre 2019
VLE Flux Jour	Flux Ligne 2									MarcheFourL2 hh:mm:ss
	CO Kg	GOT Kg	HCL Kg	NOx Kg	POUSSIERE Kg	SO2 Kg	NH3 Kg			
Unité	57,61	19,2	19,2	153,6	19,2	96	19,2			
00:30	0.413	0.022	0.039	2.785	0.141	0.000	0.004	00:30:00		
01:00	0.369	0.023	0.027	3.625	0.199	0.000	0.007	00:30:00		
01:30	0.327	0.022	0.025	3.651	0.180	0.000	0.006	00:30:00		
02:00	0.349	0.021	0.026	2.823	0.184	0.000	0.002	00:30:00		
02:30	0.329	0.021	0.025	3.288	0.187	0.000	0.003	00:30:00		
03:00	0.348	0.021	0.025	3.208	0.181	0.000	0.002	00:30:00		
03:30	0.353	0.021	0.051	2.920	0.196	0.000	0.005	00:30:00		
04:00	0.353	0.022	0.038	3.692	0.227	0.000	0.003	00:30:00		
04:30	0.343	0.023	0.034	4.023	0.237	0.000	0.004	00:30:00		
05:00	0.368	0.023	0.035	2.535	0.199	0.000	0.005	00:30:00		
05:30	0.393	0.023	0.034	2.651	0.181	0.000	0.004	00:30:00		
06:00	0.334	0.024	0.032	3.407	0.217	0.000	0.002	00:30:00		
06:30	0.332	0.023	0.053	2.799	0.173	0.000	0.002	00:30:00		
07:00	0.339	0.023	0.037	3.984	0.187	0.000	0.002	00:30:00		
07:30	0.333	0.023	0.037	2.431	0.175	0.000	0.002	00:30:00		
08:00	0.322	0.022	0.034	3.598	0.165	0.000	0.002	00:30:00		
08:30	0.319	0.022	0.030	2.947	0.174	0.000	0.002	00:30:00		
09:00	0.334	0.022	0.031	3.097	0.159	0.000	0.002	00:30:00		
09:30	0.329	0.023	0.049	3.373	0.188	0.000	0.002	00:30:00		
10:00	0.317	0.023	0.035	3.327	0.210	0.000	0.002	00:30:00		
10:30	0.327	0.022	0.033	3.088	0.189	0.000	0.002	00:30:00		
11:00	0.339	0.022	0.031	3.021	0.172	0.000	0.002	00:30:00		
11:30	0.332	0.022	0.029	3.238	0.176	0.001	0.002	00:30:00		
12:00	0.342	0.022	0.028	3.092	0.168	0.000	0.002	00:30:00		
12:30	0.344	0.022	0.048	3.640	0.173	0.000	0.003	00:30:00		
13:00	0.323	0.022	0.035	3.336	0.188	0.000	0.002	00:30:00		
13:30	0.394	0.022	0.033	2.169	0.160	0.000	0.002	00:30:00		
14:00	0.381	0.019	0.032	1.632	0.062	0.000	0.004	00:30:00		
14:30	0.308	0.021	0.028	3.384	0.111	0.000	0.003	00:30:00		
15:00	0.293	0.022	0.026	3.228	0.181	0.000	0.003	00:30:00		
15:30	0.279	0.021	0.046	3.026	0.161	0.000	0.003	00:30:00		
16:00	0.287	0.021	0.033	3.357	0.135	0.000	0.002	00:30:00		
16:30	0.302	0.022	0.030	3.408	0.114	0.000	0.002	00:30:00		
17:00	0.297	0.022	0.027	3.556	0.101	0.000	0.003	00:30:00		
17:30	0.304	0.022	0.026	3.309	0.114	0.000	0.003	00:30:00		
18:00	0.304	0.022	0.025	3.277	0.096	0.000	0.002	00:30:00		
18:30	0.293	0.023	0.040	4.003	0.127	0.000	0.002	00:30:00		
19:00	0.312	0.024	0.029	2.854	0.136	0.000	0.002	00:30:00		
19:30	0.301	0.023	0.026	3.214	0.122	0.000	0.003	00:30:00		
20:00	0.297	0.024	0.024	3.644	0.125	0.000	0.002	00:30:00		
20:30	0.344	0.025	0.022	3.160	0.156	0.000	0.002	00:30:00		
21:00	0.319	0.024	0.022	3.200	0.154	0.000	0.002	00:30:00		
21:30	0.308	0.024	0.039	3.221	0.163	0.000	0.003	00:30:00		
22:00	0.306	0.025	0.028	3.658	0.134	0.000	0.002	00:30:00		
22:30	0.297	0.025	0.024	2.754	0.147	0.000	0.002	00:30:00		
23:00	0.296	0.024	0.021	3.428	0.120	0.000	0.003	00:30:00		
23:30	0.289	0.023	0.020	3.709	0.108	0.000	0.004	00:30:00		
00:00	0.313	0.024	0.019	3.494	0.121	0.000	0.007	00:30:00		
Min	0.279	0.019	0.019	1.632	0.062	0.000	0.002			
Max	0.413	0.025	0.053	4.023	0.237	0.001	0.007			
Cumul	15.735	1.081	1.521	134.744	7.673	0.001	0.137	24:00:00		
Dep VLE Flux Jour	0	0	0	0	0	0	0			

 RECYCLAGE ET VALORISATION FRANCE  HOTEL TERRITOIRE A DE L'ENERGIE	BL Infrastructures Direction Valorisation Energétique IDF	APPLICATION : Obligatoire / Recommandé / Informatif
	FICHE D'INCIDENT	DIFFUSION : Confidentiel / Restreint / Interne / Public
		REFERENCE : 09 VLM ENG Fiche d'incident V9 du 24 septembre 2019
		STATUT : Approuvé / En révision / Périmé

FICHE D'INCIDENT N° 20 - 02

Date de l'incident : 22/10/2019 Heure : 00h00 à 24h00 Date d'ouverture de la fiche : 05/02/2020

Destinataires :

DRIEE- IF
ud94.drlee-if@developpement-durable.gouv.fr ;
mary-anne.mathleu@developpement-durable.gouv.fr ;
jean-marie.chabane@developpement-durable.gouv.fr ;
xavier.charon@developpement-durable.gouv.fr

Préfecture
pref-environnement@val-de-marne.gouv.fr
 SMITDUVM
amvinols@gpsea.fr; p.tison@gpsea.fr; cdaut@gpsea.fr;
 Autre

Secteur de l'usine touché :

- EMERAUDE**
- Hall de déchargement
 - Fosse
 - Fours/chaudières
 - Traitement fumées / effluent
 - Bâtiment administratif
 - Tours aéroréfrigérante

- DAS**
- Hall de déchargement
 - Bâtiment administratif
 - Manutention
 - Four /Chaudières
 - Traitement fumés / effluent
 - Tour aéroréfrigérante

- AUTRE**
- Rejet liquide usine
 - Voies de circulation
 - Environnement usine

Evaluation de la situation :

- Problème d'incendie
- Problème d'analyseur
- Impact sonore
- Impact visuel
- Problème de pollution
 - Dégagement de fumées
 - Dépassement de seuils polluants
 - Dépassement du seuil en légionelles de 100 000 UFC/l
 - Pollution accidentelle au niveau du stockage des produits
 - Huile Fioul
 - Autres :

Etat de la situation :

- PIOS déclenché Maîtrisé Non maîtrisé En cours de traitement
- Dégât matériel : Victime /état :

Origine du problème rencontré :

- Non identifiée Identifiée :

Dépassement de la moyenne journalière en HCl de la ligne DAS à 11,6 mg/Nm3 (pour un seuil à 10) lors du contrôle réglementaire des rejets de polluants à l'atmosphère du 2eme semestre 2019 (rapport LECES reçu le 15 janvier 2020 pour des prélèvements réalisés le 22 octobre 2019). Le flux HCl jour est conforme sur le rapport de contrôle réglementaire 4,39 kg/j pour une VLE à 5,85). Le rapport jour d'auto surveillance du 22/10 était conforme à 7,62 mg/Nm3. La VLE 1/2h n'a pas été dépassée sur la journée.

Moyens déjà engagés : Arrêt de la ligne pour reprise étanchéité des tubes de l'échangeur fumées / fumées du 11 au 14 novembre 2019. Retour à des concentrations inférieures à la VLE après intervention.

Moyens complémentaires à demander : Contre analyse réglementaire à lancer début 2020.

Pièces jointes :
 Rapport journalier d'auto surveillance du 22/10/2019 – rapport mensuel Décembre 2019.

Nom, fonction et signature du déclarant :

Marie-Christine VIRATELLE, Directrice de Site

VALO'MARNE
 10/11, rue des Malfourches
 94034 CRETEIL Cedex
 Tél. : 01.48.98.55.11
 Fax : 01.48.98.48.83
 SIRET : 833 021 232 00017



Rapport DREAL Journalier Ligne 4



Rapport journalier													22 Octobre 2011	
Mesure IC95 Ligne4														
Unité	CO	COT	HCL	NH3	NOX	POUSSIERE	SO2	Vitesse30_T4_20	O2	T2S_30_L4	MarcheFour.L_10	Tonnage DASRI		
VLE 1/2h	mg/Nm3	mg/Nm3	mg/Nm3	mg/Nm3	mg/Nm3	mg/Nm3	mg/Nm3	m/s	%	degreC	heures:ss	Tonne		
VLE max	100	20	60	20	180	30	200							
Seuil Min.	50	10	10	10	100	10	50		12	880				
VLE Jour														
00:30	8.65	0.00	4.73	2.67	59.07	0.283	1.14	19.30	9.39	993.1	00:30:00	0		
01:00	3.62	0.00	4.48	2.76	59.88	0.280	1.33	19.09	9.31	1003.6	00:30:00	0		
01:30	2.48	0.00	4.71	2.73	55.62	0.295	1.46	18.46	9.44	993.1	00:30:00	0		
02:00	1.94	0.00	5.00	2.60	72.48	0.289	1.37	19.68	9.30	1003.6	00:30:00	0		
02:30	1.62	0.00	5.96	2.59	95.98	0.305	1.67	21.93	9.46	1013.7	00:30:00	0		
03:00	2.16	0.00	7.40	2.48	67.80	0.298	2.03	20.33	9.36	1017.3	00:30:00	0		
03:30	1.74	0.00	8.86	2.47	73.08	0.300	1.81	20.77	9.42	1021.0	00:30:00	0		
04:00	2.03	0.00	9.72	2.27	76.11	0.310	1.75	20.88	9.46	1025.0	00:30:00	0		
04:30	2.37	0.00	10.34	2.23	67.66	0.317	1.67	20.41	9.33	1017.4	00:30:00	0		
05:00	2.62	0.00	10.58	2.16	70.34	0.309	1.57	20.31	9.47	1016.9	00:30:00	0		
05:30	2.31	0.00	10.88	2.22	73.27	0.313	1.77	20.93	9.46	1021.4	00:30:00	0		
06:00	2.06	0.00	10.97	2.19	65.97	0.310	1.76	20.74	9.48	1019.3	00:30:00	0		
06:30	1.29	0.00	12.71	1.81	94.46	0.315	2.00	20.60	9.44	1032.0	00:30:00	0		
07:00	2.60	0.00	10.51	1.49	48.23	0.314	2.31	17.10	9.53	1003.9	00:30:00	0		
07:30	3.27	0.00	8.82	1.23	24.13	0.306	2.10	13.94	9.56	977.2	00:30:00	0		
08:00	1.66	0.00	8.46	1.30	49.77	0.301	1.93	14.70	9.35	992.4	00:30:00	0		
08:30	1.48	0.00	8.24	1.30	60.65	0.300	1.71	15.68	9.48	1002.6	00:30:00	0		
09:00	2.35	0.00	8.09	1.34	48.28	0.327	2.86	15.20	10.24	984.3	00:30:00	0		
09:30	1.78	0.00	6.80	1.52	61.60	0.316	3.47	16.54	9.86	964.0	00:30:00	0		
10:00	2.26	0.00	7.89	1.87	63.93	0.300	4.20	20.19	9.56	988.0	00:30:00	0		
10:30	1.54	0.00	9.23	1.89	65.61	0.279	4.37	19.39	9.53	999.8	00:30:00	0		
11:00	2.35	0.00	10.11	2.06	67.88	0.290	4.49	18.95	9.53	999.8	00:30:00	0		
11:30	2.72	0.00	8.77	2.21	59.96	0.309	3.96	18.77	9.81	990.8	00:30:00	0		
12:00	7.74	0.09	7.88	2.30	56.23	0.306	3.86	17.97	9.95	987.9	00:30:00	0		
12:30	2.10	0.00	7.35	2.13	63.39	0.280	3.44	19.30	9.49	999.6	00:30:00	0		
13:00	1.24	0.00	6.67	1.93	78.07	0.267	3.06	17.90	9.28	1017.5	00:30:00	0		
13:30	1.28	0.00	6.26	1.75	53.37	0.272	3.15	15.81	9.49	998.0	00:30:00	0		
14:00	1.64	0.00	6.12	1.68	56.64	0.280	3.01	14.61	9.63	988.9	00:30:00	0		
14:30	2.61	0.00	6.13	1.83	63.14	0.273	2.84	16.03	9.73	968.6	00:30:00	0		
15:00	1.28	0.00	5.94	1.60	71.18	0.255	2.38	17.52	9.21	1011.1	00:30:00	0		
15:30	2.81	0.00	7.38	1.39	52.44	0.258	2.37	16.45	9.55	994.9	00:30:00	0		
16:00	2.30	0.00	7.60	1.30	78.91	0.258	2.15	18.43	9.32	1015.6	00:30:00	0		
16:30	1.26	0.00	8.49	1.42	81.24	0.261	1.60	17.65	9.52	1027.1	00:30:00	0		
17:00	1.25	0.00	7.85	1.24	69.54	0.253	1.54	16.42	9.44	1018.5	00:30:00	0		
17:30	1.26	0.00	7.23	1.18	45.81	0.258	1.78	14.78	9.42	998.5	00:30:00	0		
18:00	1.30	0.00	7.62	1.21	41.16	0.277	2.70	14.97	9.67	992.9	00:30:00	0		
18:30	2.03	0.00	7.95	1.47	55.99	0.285	1.48	14.92	10.10	960.0	00:30:00	0		
19:00	1.40	0.00	8.19	1.67	77.15	0.261	0.99	20.18	9.30	998.9	00:30:00	0		
19:30	1.55	0.00	9.49	1.95	90.44	0.276	1.31	21.29	9.61	1016.1	00:30:00	0		
20:00	1.77	0.00	8.89	1.83	48.57	0.264	1.30	15.64	9.55	991.8	00:30:00	0		
20:30	Arrêt	Arrêt	Arrêt	Arrêt	Arrêt	Arrêt	Arrêt	Arrêt	Arrêt	Arrêt	00:00:00	0		
21:00	Arrêt	Arrêt	Arrêt	Arrêt	Arrêt	Arrêt	Arrêt	Arrêt	Arrêt	Arrêt	00:00:00	0		
21:30	Arrêt	Arrêt	Arrêt	Arrêt	Arrêt	Arrêt	Arrêt	Arrêt	Arrêt	Arrêt	00:00:00	0		
22:00	08.25	0.00	3.43	1.48	37.33	0.293	0.63	15.44	10.37	935.6	00:30:00	0		
22:30	2.36	0.00	4.09	1.84	74.71	0.282	0.64	14.71	10.07	957.3	00:30:00	0		
23:00	1.63	0.00	4.21	1.71	66.76	0.263	0.80	14.89	9.44	986.7	00:30:00	0		
23:30	2.30	0.00	4.74	1.77	37.87	0.277	1.04	15.08	10.27	956.6	00:30:00	0		
00:00	2.44	0.00	5.81	1.76	62.97	0.263	1.48	15.98	9.68	969.7	00:30:00	0		
Max.	64.25	0.09	12.71	2.76	95.98	0.317	4.49	21.93	10.57	1033.7		0		
Min.	1.24	0.00	3.43	1.18	34.13	0.253	0.63	13.94	9.21	938.6		0		
Moy/Cumul	3.78	0.00	7.62	1.87	64.17	0.287	2.14	17.76	9.60	997.1	22:26:00	0		
Dép. VLE 1/2h	0	0	0	0	0	0	0	0	0	0		0		
Dép. VLE max	00:00	00:00				00:00								
Indisponibilité % données IIG	0.00	0.00	0.00	0.00	0.00	0.00	0.00	0.00	0.00	0.00	0.00	0.00		
Invalidité	0	0	0	0	0	0	0	0	0	0	0	0		
Dép. VLE Jour	0	0	0	0	0	0	0	0	0	0	0	0		

Contrôle réglementaire (14/2011) (11)												
	CO	COT	HCL	NOX	POUSSIERE	SO2	Total					
Dépassement >4H	0	0	0	0	0	0	0	0	0	0	0	0
Dép. VLE	00.00	0.00	0.00	00.00	00.00	00.00	00.00	00.00	00.00	00.00	00.00	20.00
Nb jour invalides	1	2	1	1	1	1	1	1	1	1	1	1
Indis. Cons >10h	0	0	0	0	0	0	0	0	0	0	0	0
Indisponibilité	08.00	16.30	08.00	08.00	08.00	08.00	08.00	08.00	08.00	08.00	08.00	16.30

Rapport DREAL Mensuel Ligne 4

Mesure (CS5) Ligne 4		Decembre 2019									
Unité	CO2 mg/Nm3	HCL mg/Nm3	NH3 mg/Nm3	NOX mg/Nm3	POUSSIÈRE mg/Nm3	SO2 mg/Nm3	Vitesse30_T4_2C m/s	O2 %	TAS_30_L4 degreC	MarcheFourL4_30 hh mm:ss	Tempsage D'ASRI Tonne
VLE Jour	50	10	10	10	100	10	50	12	850		
VLE Max	100	20	60	20							
Seuil Min	100										
Seuil V/2h											
01/12/2019	3.48	0.00	7.09	0.52	74.35	0.316	0.73	17.91	9.83	997.8	22:21:40
02/12/2019	2.20	0.01	9.16	0.75	71.19	0.312	0.79	18.96	9.75	990.7	23:37:16
03/12/2019	2.12	0.00	9.64	0.65	65.51	0.319	0.77	19.00	9.78	992.0	23:44:50
04/12/2019	2.70	0.00	7.96	0.83	61.75	0.314	1.17	17.61	9.69	970.1	21:43:30
05/12/2019	4.40	0.00	7.99	0.96	66.00	0.347	0.73	16.96	9.97	987.4	22:42:30
06/12/2019	1.66	0.00	9.23	1.30	74.02	0.328	0.60	18.70	9.82	1018.0	23:32:30
07/12/2019	1.83	0.00	9.17	1.08	69.57	0.283	0.57	18.63	9.80	1010.3	23:52:20
08/12/2019	5.82	0.02	6.41	1.16	65.83	0.287	0.70	16.69	9.90	977.0	21:36:40
09/12/2019	8.21	0.00	8.48	1.07	60.50	0.297	0.61	15.68	9.91	970.6	21:36:40
10/12/2019	2.72	0.00	9.32	0.78	64.77	0.317	0.92	16.39	9.71	992.6	23:42:30
11/12/2019	3.41	0.00	9.22	0.99	77.46	0.310	0.78	17.65	9.76	997.4	23:20:30
12/12/2019	5.88	0.00	8.78	1.48	90.84	0.305	0.82	18.51	9.88	1026.7	22:46:30
13/12/2019	6.97	0.02	9.18	1.83	83.16	0.285	0.76	17.78	9.68	1029.7	21:19:00
14/12/2019	1.69	0.00	9.22	1.29	89.30	0.284	0.61	16.02	9.67	1049.7	25:48:50
15/12/2019	1.95	0.00	7.20	0.63	99.50	0.284	0.61	16.02	9.67	1049.7	14:04:50
16/12/2019	8.43	0.00	4.85	0.45	85.23	0.268	0.79	16.52	9.60	999.3	16:23:00
17/12/2019	3.58	0.02	8.48	0.58	76.46	0.270	0.90	17.86	9.69	1007.1	22:56:00
18/12/2019	2.65	0.00	8.88	0.87	82.46	0.284	0.81	17.21	9.65	1009.0	23:57:20
19/12/2019	4.21	0.00	9.50	0.80	73.12	0.271	0.86	16.04	9.97	990.2	23:17:00
20/12/2019	2.33	0.00	8.50	0.99	71.75	0.300	0.87	16.03	9.82	1015.9	23:58:00
21/12/2019	1.68	0.01	8.25	1.25	73.28	0.297	0.94	17.36	9.80	1018.5	24:00:00
22/12/2019	4.52	0.02	7.45	0.87	71.92	0.275	0.94	14.37	9.78	1022.0	15:17:10
23/12/2019	2.72	0.01	8.36	0.69	69.73	0.274	0.94	14.37	9.63	1011.0	16:57:30
24/12/2019	2.25	0.00	8.11	0.96	69.83	0.272	0.79	14.95	9.66	1011.6	23:53:10
25/12/2019	8.28	0.03	4.80	0.71	62.40	0.294	0.66	15.00	9.66	1015.6	23:17:40
26/12/2019	5.95	0.00	4.07	1.57	64.68	0.265	0.70	14.94	10.05	992.4	12:41:00
27/12/2019	5.19	0.03	6.69	1.07	68.31	0.284	0.65	14.21	9.64	1000.2	19:56:50
28/12/2019	5.13	0.50	8.52	0.69	63.53	0.321	0.64	14.72	9.76	1003.5	17:52:10
29/12/2019	4.24	0.21	8.20	0.91	74.73	0.317	1.02	15.40	9.64	1027.7	18:54:50
30/12/2019	8.43	0.50	9.64	1.83	99.50	0.347	1.17	19.12	10.05	1049.7	23:05:10
31/12/2019	1.66	0.00	4.07	0.42	66.50	0.265	0.56	14.27	9.60	970.1	0.0
Min.	0	0	0	0	0	0	0	0	0	0	0
Max.	0	0	0	0	0	0	0	0	0	0	0
Dep. VLE jour	11	0	0	0	0	0	0	0	0	0	0
Nb Jour Inv.	4.85	0.03	8.22	0.95	71.41	0.297	0.78	16.90	9.77	1004.9	26j 11h36:39
Dep. VLE Max	0.00	0.00	0.00	0.00	0.00	0.000	0.00	0.00	0.00	0.0	0
Dep. Seuil Min.	0.00	0.00	0.00	0.00	0.00	0.000	0.00	0.00	0.00	0.0	0
Dep. VLE 1/2h	11	0	0	0	0	0	0	0	0	0	0
Moy. Mensuelle	4.85	0.03	8.22	0.95	71.41	0.297	0.78	16.90	9.77	1004.9	26j 11h36:39
% données HG	0.00	0.00	0.00	0.00	0.00	0.000	0.00	0.00	0.00	0.0	0
% données HC	0.00	0.00	0.00	0.00	0.00	0.000	0.00	0.00	0.00	0.0	0
Annuel											

Caudes de température L4 - 2019 (CS5)		Decembre 2019									
Unité	CO2 mg/Nm3	HCL mg/Nm3	NH3 mg/Nm3	NOX mg/Nm3	POUSSIÈRE mg/Nm3	SO2 mg/Nm3	Vitesse30_T4_2C m/s	O2 %	TAS_30_L4 degreC	MarcheFourL4_30 hh mm:ss	Tempsage D'ASRI Tonne
Dep. VLE	30	0	0	0	0	0	0	0	0	0	0
Nb jour Invalides	3	0	0	0	0	0	0	0	0	0	0
Indisponibilité	08:00	16:30	08:00	08:00	08:00	08:00	08:00	08:00	08:00	08:00	08:00
Le 05/12/2019, dépassement d'une moyenne 30 en CO à 123.2 mg/Nm3 (pour une limite à 100) consécutif à plusieurs arrêts de ligne maintenance.											
Le 08/12/2019, dépassement d'une moyenne 30 en CO à 103.94 mg/Nm3 (pour une limite à 100) consécutif à la reprise du chargement suite à un arrêt pour nettoyage et contrôle sortie four.											
Le 16/12/2019, dépassement de deux moyennes 30 en CO à 104.85 mg/Nm3 et à 102.65 mg/Nm3 (pour une limite à 100) lors de la reprise du chargement.											
Le 22/12/2019, dépassement d'une moyenne 30 en CO à 101.34 mg/Nm3 (pour une limite à 100) suite à un arrêt de changement sur un blocage piston enfouissement.											
Le 23/12/2019, dépassement d'une moyenne 30 en CO à 107.49 mg/Nm3 (pour une limite à 100) suite à une reprise de chargement après stock 0.											
Le 25/12/2019, dépassement d'une moyenne 30 en CO à 112.46 mg/Nm3 (pour une limite à 100) suite à un arrêt intempestif de la chaîne de maintenance.											
Le 26/12/2019, dépassement d'une moyenne 30 en CO à 128.28 mg/Nm3 (pour une limite à 100) suite à une reprise de chargement après stock 0.											

 <small>RECYCLAGE ET VALORISATION FRANCE</small>  <small>NOTRE TERRITOIRE A DE L'ENERGIE</small>	BL Infrastructures Direction Valorisation Energétique IDF	APPLICATION : Obligatoire / Recommandé / Informatif
	FICHE D'INCIDENT	DIFFUSION : Confidentiel / Restreint / Interne / Public
		REFERENCE : 09 VLM ENG Fiche d'incident V9 du 24 septembre 2019
		STATUT : Approuvé / En révision / Périmé

FICHE D'INCIDENT N° 2020 - 03

Date de l'incident : 24/10/2019 Heure : 00h00 à 24h00 Date d'ouverture de la fiche : 05/02/2020

Destinataires :

DRIEE- IF
ud94.driee-if@developpement-durable.gouv.fr ;
mary-anne.mathieu@developpement-durable.gouv.fr ;
jean-marie.chabane@developpement-durable.gouv.fr ;
xavier.charon@developpement-durable.gouv.fr

Préfecture
pref-environnement@val-de-marne.gouv.fr
 SMITDUVM
amvinois@gpsea.fr; ptison@gpsea.fr; cdaut@gpsea.fr;
 Autre

Secteur de l'usine touché :

- EMERAUDE**
- Hall de déchargement
 - Fosse
 - Fours/chaudières
 - Traitement fumées / effluent
 - Bâtiment administratif
 - Tours aéroréfrigérante

- DAS**
- Hall de déchargement
 - Bâtiment administratif
 - Manutention
 - Four /Chaudières
 - Traitement fumés / effluent
 - Tour aéroréfrigérante

- AUTRE**
- Rejet liquide usine
 - Voies de circulation
 - Environnement usine

Evaluation de la situation :

- Problème d'incendie
- Problème d'analyseur
- Impact sonore
- Impact visuel
- Problème de pollution
 - Dégagement de fumées
 - Dépassement de seuils polluants
 - Dépassement du seuil en légionelles de 100 000 UFC/l
 - Pollution accidentelle au niveau du stockage des produits
 - Huile Fioul
 - Autres :

Etat de la situation :

- PIOS déclenché Maîtrisé Non maîtrisé En cours de traitement
- Dégât matériel : Victime /état :

Origine du problème rencontré :

Non identifiée Identifiée :

- Dépassement de la valeur flux jour en NOx sur la ligne n°2 à 160 kg/j (pour un seuil à 153,6 kg/j) lors du contrôle réglementaire des rejets de polluants à l'atmosphère du 2eme semestre 2019 (rapport LECES reçu le 15 janvier 2020 pour des prélèvements réalisés le 24 octobre 2019). Le rapport jour d'auto surveillance était conforme à 115,99 kg/j. La concentration du rapport semestriel était conforme à 74,7 mg/Nm3 pour une VLE à 80 mg/Nm3.
 - Dépassement en concentration mercure à 67,5 µg/Nm3 (pour un seuil à 50 µg/Nm3) et en flux mercure à 144 g/j (pour un seuil à 96 g/j) lors du contrôle réglementaire des rejets de polluants à l'atmosphère du 2eme semestre 2019 (rapport LECES reçu le 15 janvier 2020 pour des prélèvements réalisés le 24 octobre 2019).
- Dépassements probablement dus à une mauvaise qualité de déchets.

Moyens déjà engagés : Vérification du débit d'Injection de TMT 15 dans les laveurs (permet de capter le mercure), et de l'Injection d'ammoniaque dans la Denox (permet de capter les NOx).

Moyens complémentaires à demander : Contre analyses réglementaires à prévoir début 2020

Pièces jointes : Rapport du contrôle réglementaire du 06 janvier 2020 et rapport journalier d'auto surveillance du 24/10/2020.

Nom, fonction et signature du déclarant :

VALO'MARNE
 10/11, rue des Malfourches
 94034 CRETEIL Cedex
 Tél. : 01.48.98.55.11
 Fax : 01.48.98.48.03
 SIRET : 833 921 20 00 00

Marie-Christine Viratelle

Rapport DREAL Flux Journalier Ligne 2

Rapport Flux Journalier										24 Octobre 2019
FLUX Ligne 2										
VLE Flux Jour	Unité	CO Kg	COT Kg	HCL Kg	NOx Kg	POUSSIERE Kg	SO2 Kg	NH3 Kg	MarcheFourL2 hh:mm:ss	
		57.61	19.2	19.2	153.6	19.2		96	19.2	
00:30		0.307	0.026	0.069	2.843	0.150	0.000	0.002	00:30:0	
01:00		0.305	0.027	0.047	2.650	0.120	0.000	0.002	00:30:0	
01:30		0.284	0.026	0.044	2.642	0.120	0.000	0.002	00:30:0	
02:00		0.310	0.026	0.042	2.590	0.134	0.000	0.002	00:30:0	
02:30		0.294	0.027	0.040	2.584	0.144	0.000	0.002	00:30:0	
03:00		0.320	0.026	0.038	2.773	0.118	0.000	0.002	00:30:0	
03:30		0.307	0.027	0.063	2.330	0.124	0.000	0.002	00:30:0	
04:00		0.298	0.027	0.046	2.937	0.148	0.000	0.002	00:30:0	
04:30		0.304	0.027	0.041	2.687	0.168	0.000	0.002	00:30:0	
05:00		0.270	0.027	0.041	2.457	0.155	0.000	0.002	00:30:0	
05:30		0.317	0.026	0.038	2.779	0.131	0.000	0.002	00:30:0	
06:00		0.299	0.027	0.036	2.695	0.125	0.000	0.003	00:30:0	
06:30		0.303	0.026	0.058	2.993	0.134	0.000	0.002	00:30:0	
07:00		0.332	0.025	0.041	2.306	0.143	0.000	0.002	00:30:0	
07:30		0.317	0.026	0.037	2.859	0.193	0.000	0.002	00:30:0	
08:00		0.316	0.026	0.037	2.390	0.246	0.000	0.002	00:30:0	
08:30		0.282	0.023	0.031	2.780	0.221	0.000	0.002	00:30:0	
09:00		0.255	0.022	0.031	1.928	0.175	0.000	0.001	00:30:0	
09:30		0.246	0.022	0.048	2.719	0.182	0.000	0.002	00:30:0	
10:00		0.270	0.023	0.035	2.155	0.179	0.000	0.001	00:30:0	
10:30		0.262	0.023	0.032	2.289	0.179	0.000	0.002	00:30:0	
11:00		0.251	0.023	0.032	2.199	0.180	0.000	0.001	00:30:0	
11:30		0.269	0.024	0.032	2.382	0.177	0.000	0.001	00:30:0	
12:00		0.267	0.022	0.033	2.064	0.171	0.000	0.001	00:30:0	
12:30		0.253	0.023	0.058	1.899	0.191	0.000	0.001	00:30:0	
13:00		0.256	0.022	0.045	2.238	0.171	0.000	0.001	00:30:0	
13:30		0.284	0.021	0.047	1.954	0.170	0.781	0.001	00:30:0	
14:00		0.282	0.022	0.048	2.322	0.203	0.011	0.002	00:30:0	
14:30		0.284	0.021	0.051	1.813	0.168	0.036	0.001	00:30:0	
15:00		0.348	0.025	0.057	2.229	0.184	0.000	0.002	00:30:0	
15:30		0.345	0.025	0.084	2.383	0.254	0.000	0.002	00:30:0	
16:00		1.308	0.025	0.066	0.866	0.059	0.000	0.003	00:30:0	
16:30		0.208	0.027	0.081	0.903	0.045	0.003	0.002	00:30:0	
17:00		0.340	0.026	0.084	2.875	0.105	0.001	0.002	00:30:0	
17:30		0.365	0.026	0.076	2.567	0.115	0.015	0.003	00:30:0	
18:00		0.339	0.025	0.074	2.143	0.148	0.018	0.002	00:30:0	
18:30		0.360	0.025	0.129	2.702	0.147	0.000	0.002	00:30:0	
19:00		0.344	0.027	0.085	2.236	0.140	0.000	0.002	00:30:0	
19:30		0.367	0.026	0.073	2.264	0.125	0.000	0.002	00:30:0	
20:00		0.309	0.024	0.064	1.963	0.144	0.000	0.002	00:30:0	
20:30		0.296	0.026	0.057	2.245	0.149	0.000	0.002	00:30:0	
21:00		0.333	0.026	0.047	2.677	0.153	0.000	0.002	00:30:0	
21:30		0.297	0.024	0.076	2.049	0.128	0.000	0.002	00:30:0	
22:00		0.335	0.025	0.050	3.123	0.118	0.000	0.002	00:30:0	
22:30		0.337	0.025	0.041	2.498	0.123	0.000	0.002	00:30:0	
23:00		0.341	0.028	0.040	2.659	0.109	0.000	0.002	00:30:0	
23:30		0.348	0.026	0.035	3.174	0.119	0.000	0.002	00:30:0	
00:00		0.347	0.025	0.032	3.180	0.130	0.000	0.002	00:30:0	
Min		0.208	0.021	0.031	0.866	0.045	0.000	0.001		
Max		1.308	0.028	0.129	3.180	0.254	0.781	0.003		
Cumul		15.611	1.199	2.492	115.993	7.215	0.865	0.090	24:00:0	
Dep VLE Flux Jour		0	0	0	0	0	0	0		

11. Bilan de l'impact sur l'environnement

**- VALO'MARNE-
Site de CRETEIL**

**Surveillance des retombées atmosphériques
de Dioxine-Furane et métaux lourds**

Campagne de mesures AUTOMNE 2019

(Octobre – Novembre 2019)

B. RICCHI

CLIENT : **VALO'MARNE**
ZI CARREFOUR POMPADOUR
10, 11 Rue des Malfourches
94034CRETEIL

N° de DOSSIER MAITRE : 8 19 0098

RÉDACTEUR : **Christelle GAUTIER**

DESTINATAIRES : M.CHERVY (2 copies)
Dossier Maître (1 copie)

	Vérificateur	Approbateur
Nom	A. BUGAUD	B. RICCHI
Fonction	Resp. Unité LYON	Responsable Unité IDF
Signature		

SOMMAIRE

1	INTRODUCTION.....	3
2	METHODOLOGIE.....	4
2.1	POINTS DE MESURE.....	4
2.2	CAMPAGNES DE MESURES.....	5
2.3	METHODOLOGIE DE MESURE.....	5
2.3.1	Mesures des retombées de poussières et des métaux et PCDD/F contenus dans les retombées.....	5
2.3.2	Données météorologiques.....	6
3	MÉTHODOLOGIE D'INTERPRÉTATION DES RÉSULTATS.....	7
3.1	VALEURS DE REFERENCE.....	7
3.1.1	Retombées atmosphériques et métaux contenus dans les retombées.....	7
3.1.2	PCDD et PCDF.....	8
3.2	EXPLOITATION DES DONNEES METEOROLOGIQUES.....	8
4	RÉSULTATS.....	10
4.1	RETOMBEES ATMOSPHERIQUES ET DEPOTS DE METAUX.....	10
4.2	PCDD/F ET PBDD/F DANS LES RETOMBEES DE POUSSIÈRES.....	12
4.2.1	PolyChloroDibenzoDioxines et PolyChloroDibenzoFurannes dans les retombées de poussières.....	12
4.2.2	PolyBromoDibenzoDioxines et PolyBromoDibenzoFurannes dans les retombées de poussières.....	13
5	CONCLUSION.....	14

TABLEAUX

Tableau 1.	- Localisation des points de prélèvement.....	4
Tableau 2.	- Polluants mesurés à chaque point de prélèvement.....	5
Tableau 3.	- Valeurs de référence pour les retombées de poussières et leur contenu.....	7
Tableau 4.	-Valeur indicative pour les retombées de poussières et leur contenu.....	8
Tableau 5.	- Retombées atmosphériques (mg/m ² /jour) et dépôts de métaux (µg/m ² /jour).....	10
Tableau 6.	- Concentrations pondérées en PCDD/PCDF dans les retombées de poussières (pg _{OMS-TEQ} /m ² /jour).....	12

ANNEXES

ANNEXE 1	Position des points de mesure.....	16
ANNEXE 2	Rose des vents correspondant à la période de mesure.....	18
ANNEXE 3	Evolution des dépôts atmosphériques.....	20

oOo

1 INTRODUCTION

VALO'MARNE est soumis, par l'arrêté ministériel du 20 septembre 2002 relatif aux installations d'incinération et de co-incinération de déchets non dangereux et aux installations incinérant des déchets d'activités de soins à risques infectieux, à une surveillance de l'impact sur l'environnement au voisinage de l'installation. Le programme initialement déterminé en 2011 a été confié au LECES en 2017 et 2018.

Les paramètres à prendre en compte dans le cadre de ce programme de surveillance de la qualité de l'atmosphère sont :

- /// dans l'air ambiant :
 - ✓ les métaux (As, Cd, Co, Cu, Hg, Mn, Ni, Pb, Sn, Tl) contenus dans les retombées atmosphériques,
 - ✓ les **D**ioxines et **F**urannes (17 congénères de PCDD/F) dans les retombées atmosphériques.

En ce qui concerne l'air ambiant, les mesures sont programmées annuellement.

Les niveaux mesurés sont interprétés par rapport aux conditions météorologiques relevées à la station météorologique METEO FRANCE implantée sur la commune de SAINT-MAUR-DES-FOSSES.

Le présent rapport fournit les résultats observés au cours de la campagne de mesures des teneurs en polluants qui a été menée par LECES du 25 octobre au 29 novembre 2019.

2 METHODOLOGIE

2.1 POINTS DE MESURE

Six points de surveillance de la qualité de l'air avaient été retenus pour l'étude en 2017. La position exacte de ces points de mesure avait été choisie et validée sur le terrain conjointement par VALO'MARNE de Créteil et par un spécialiste de LECES.

La localisation précise de ces points de prélèvement, est présentée dans le tableau 1. Dans ce tableau figurent également les secteurs pour lesquels les points de mesure sont sous les vents de VALO'MARNE de Créteil.

Tableau 1. - Localisation des points de prélèvement

N° du point	Localisation	Coordonnées Lambert II étendu (m)	Situation par rapport au site	Secteur sous les vents de l'UIOM
1	Rue Pasteur Vallery-Radot (PALAIS DES SPORTS) CRETEIL	X = 607 728 Y = 2 421 045	Nord-Nord-Est	186° - 211°
2	Avenue du Maréchal de Lattre (HOPITAL) CRETEIL	X = 608 548 Y = 2 422 062	Nord-Nord-Est	204° - 216°
3	6, rue Waldeck Rousseau (MAIRIE DE CHOISY) CHOISY-LE-ROI	X = 605 366 Y = 2 418 211	Sud-Ouest	42° - 52°
4	19, rue Eugène Hénaff (SITA IDF) VITRY-SUR-SEINE	X = 605 633 Y = 2 421 616	Nord-Ouest	124° - 135°
5	1, place Salvador Allende (MAIRIE CRETEIL) CRETEIL	X = 608 561 Y = 2 419 919	Est	268° - 292°
6	149, rue Marc Sangnier (CENTRE CULTUREL) MAISONS-ALFORT	X = 608 864 Y = 2 423 021	Nord-Nord-Est	203° - 210°

La position géographique des points de mesure est présentée dans l'annexe 1.

Le tableau 2 présente pour chaque point de surveillance les différents polluants qui ont été mesurés.

Tableau 2. - Polluants mesurés à chaque point de prélèvement

N° du point	Localisation	Retombées (Métaux, PCDD/F)
1	Rue Pasteur Vallery-Radot (PALAIS DES SPORTS) CRETEIL	X
2	Avenue du Maréchal de Lattre (HOPITAL) CRETEIL	X
3	6, rue Waldeck Rousseau (MAIRIE CHOISY) CHOISY-LE-ROI	X
4	19, rue Eugène Hénaff (SITA IDF) VITRY-SUR-SEINE	X
5	1, place Salvador Allende (MAIRIE DE CRETEIL) CRETEIL	X
6	149, rue Marc Sangnier (CENTRE SOCIO) MAISONS-ALFORT	X

2.2 CAMPAGNES DE MESURES

Chaque année, des mesures annuelles sont prévues dans le cadre de la surveillance environnementale.

En chaque point de mesure, pour les différents polluants retenus, les durées de prélèvements prévues au cours de chacune de ces campagnes sont les suivantes :

- /// 1 mois pour les retombées de poussières et leur teneur en métaux,
- /// 1 mois pour les retombées atmosphériques de PCDD/F.

2.3 METHODOLOGIE DE MESURE

2.3.1 MESURES DES RETOMBÉES DE POUSSIÈRES ET DES MÉTAUX ET PCDD/F CONTENUS DANS LES RETOMBÉES

2.3.1.1 Prélèvements

Les mesures de retombées de poussières ont été effectuées selon la norme NF X43-014, au moyen de collecteurs de précipitations de type jauges OWEN.

Pour la détermination des métaux contenus dans les retombées atmosphériques, le collecteur de précipitations est constitué d'un cône de collecte en PVC et d'un flacon de récupération en polyéthylène.

Pour la détermination des PCDD/F dans les retombées, le collecteur de précipitations est constitué d'un cône de collecte en verre pour limiter les risques de pollution de l'échantillon et d'un flacon de récupération également en verre dont le contenu est maintenu à l'abri de la lumière pour éviter les risques de dégradation des molécules sous l'action du rayonnement UV.

La période d'exposition des collecteurs a été de **35 jours**.

LECES est accrédité par le COFRAC (accréditation n°1-1975, Essais, Liste des sites accrédités et portée disponibles sur www.cofrac.fr) pour le prélèvement des retombées de poussières selon la norme NF X43-014.

2.3.1.2 Caractérisation des métaux dans les retombées de poussières

Pour chaque point de mesure, l'analyse des métaux : arsenic, cobalt, chrome, cuivre, manganèse, étain, thallium, cadmium, nickel, plomb, mercure et zinc a été réalisée sur les fractions soluble et insoluble des retombées de poussières collectées. Pour une précision maximale, l'analyse a porté sur le volume total des jauges.

La quantification des métaux dans les retombées de poussières a été réalisée par ICP-MS. Le traitement de l'échantillon et les analyses ont été effectuées par le laboratoire MICROPOLLUANTS TECHNOLOGIE SA, accrédité par le COFRAC (accréditation n° 1-1151, Essais, Portée disponible sur www.cofrac.fr) selon la norme NF EN ISO 17294-2.

2.3.1.3 Caractérisation des PCDD/F dans les retombées de poussières

Pour chaque point de mesure, l'analyse des PCDD/Fa été effectuée sur le contenu total des jauges (extraction et purification effectuées sur la totalité de la jauge).

La quantification des PCDD/F dans les retombées de poussières a été réalisée par chromatographie en phase gazeuse haute résolution, couplée à la spectrométrie de masse haute résolution (HRGC/HRMS).

Le traitement des échantillons et les analyses ont été effectués par MICROPOLLUANTS TECHNOLOGIE, accrédité par le COFRAC (accréditation n° 1-1151, Essais, Portée disponible sur www.cofrac.fr) selon une méthode interne MOp C-4/58 V6:

/// l'extraction solide-liquide, l'extraction liquide-liquide et le dosage par HRGC/HRMS des PCDD/F,

2.3.2 DONNEES METEOROLOGIQUES

Une acquisition des données météorologiques correspondant aux périodes de mesures est nécessaire pour l'interprétation des résultats des mesures de polluants réalisées dans le cadre de cette étude.

Conformément à l'arrêté préfectoral, une station de mesures des paramètres météorologiques répondant aux critères demandés par METEO FRANCE pour collecter en continu les paramètres météorologiques suivants : vitesse et direction du vent, existe dans l'environnement proche de VALO'MARNE. Il s'agit de la station météorologique METEO FRANCE implantée sur la commune de SAINT-MAUR-DES-FOSSES.

3 MÉTHODOLOGIE D'INTERPRÉTATION DES RÉSULTATS

3.1 VALEURS DE REFERENCE

Les valeurs de référence citées, lorsqu'elles existent, étant exprimées en moyenne annuelle, journalière ou horaire, la comparaison des résultats (1 mois de mesures par point) à ces valeurs est purement indicative.

3.1.1 RETOMBÉES ATMOSPHERIQUES ET METAUX CONTENUS DANS LES RETOMBÉES

Les valeurs de référence en retombées de poussières ainsi qu'en métaux lourds dans les retombées atmosphériques sont données dans le tableau 3 suivant.

En l'absence de valeurs de référence françaises, les niveaux de retombées de poussières et métaux sont comparés, à titre indicatif, aux valeurs réglementaires du TA LUFT (ALLEMAGNE, version du 24 juillet 2002) et celles définies par le Conseil fédéral suisse, exprimées en moyenne annuelle.

Les valeurs de référence allemandes et suisses sont présentées dans le tableau 3.

Tableau 3. - Valeurs de référence pour les retombées de poussières et leur contenu

	Retombées de poussières (g/m ² /j)	Arsenic (µg/m ² /j)	Nickel (µg/m ² /j)	Mercure (µg/m ² /j)	Plomb (µg/m ² /j)	Cadmium (µg/m ² /j)	Zinc (µg/m ² /j)
Valeur limite	0,35	4	15	1	100	2	400
Références	Erste Allgemeine Verwaltungsvorschrift zum Bundes-Immissionsschutzgesetz Technische Anleitung zur Reinhaltung der Luft TA Luft - Vom 24. Juli 2002					Annexe 7 de l'ordonnance sur la protection de l'air (OPair) - 814.318.142.1 du 16 décembre 1985 Valeurs limites d'immission - Mise à jour selon le ch. II de l'O du 14 oct. 2015, en vigueur depuis le 16 novembre 2015 (RO 2015 4171)	

S'il n'existe aucune norme sur les retombées en métaux, les retombées quantifiées peuvent être comparées à d'autres résultats issus de campagnes de mesures. Le tableau 4 regroupe des fourchettes de retombées en métaux lourds obtenues ces dernières années lors d'études régionales (source ATMO Champagne-Ardenne) et nationales (source INERIS)¹.

¹INERIS-DRC-04-41735-AIRE-n°0623, INERIS-DRC-0462838-AIRE-n°0947, INERIS-DRC-04-55891-AIRE-n°0565, INERIS-DRC-04-51911-AIRE-n°0792

Tableau 4. -Valeur indicative pour les retombées de poussières et leur contenu

Dépôts de métaux lourds ($\mu\text{g}/\text{m}^2/\text{j}$)	Cu	Mn	Pb	Ni	Cr
Urbain (source INERIS)	-	28-61	10	5	3,6
Bruit de fond rural (source INERIS)	-	10-16	2-10	1,8-5	1,6 - 5,4
Urbain-Périurbain (source ATMO Champagne-Ardenne 2005-2013)	7-70	6-46	2-55	-	-
Rural (source ATMO Champagne-Ardenne 2005-2013)	6-66	8-49	1-48	4,3 – 4,9	9,7 – 18,2

3.1.2 PCDD ET PCDF

Il n'existe pas de valeur de référence réglementaire pour les PCDD/F.

Toutefois, suite à l'édition, en 2012, d'un rapport du BRGM sur la surveillance environnementale des incinérateurs², les valeurs de référence suivantes ont été indiquées par l'INERIS³ :

- /// zone rurale ou bruit de fond urbain et industriel : 0 à 5 $\text{pg}_{\text{OMS-TEQ}}/\text{m}^2/\text{jour}$;
- /// zone urbaine ou environnement impacté par des activités anthropiques : 5 à 16 $\text{pg}_{\text{OMS-TEQ}}/\text{m}^2/\text{jour}$;
- /// proximité industrielle ou proximité d'une source : > 16 $\text{pg}_{\text{OMS-TEQ}}/\text{m}^2/\text{jour}$.

3.2 EXPLOITATION DES DONNEES METEOROLOGIQUES

Les données météorologiques servant à l'interprétation des résultats de mesures des polluants suivis proviennent de la station météorologique METEO FRANCE implantée sur la commune de SAINT-MAUR-DES-FOSSES.

Les données météorologiques, en particulier direction et vitesse de vent, permettent d'évaluer le taux d'exposition (en %) pour lequel les points de mesure sont sous les vents de VALO'MARNE de Créteil.

La méthode de calcul du taux d'exposition est la suivante. Chaque point de prélèvement est impacté par les rejets de VALO'MARNE de Créteil sous un secteur de vent donné (voir tableau 1 page 4). Pour chaque point de mesure correspondant à un secteur de vent donné, on a déterminé heure par heure sur la période de prélèvement :

- /// 1 mois pour les retombées atmosphériques,

Le nombre d'heures au cours desquelles la direction du vent horaire se situait dans ce secteur.

² F. BODEMAN - P. MICHEL - A. COFTIER - M. P. BOUTIN- Rapport d'étude BRGM/RP-61045-FR - Juin 2012
Surveillance environnementale des incinérateurs : bilan des campagnes (2006-2009) et valeurs guide de dépôts de dioxines sur jauges - Rapport final

³ M. DURIF- Rapport d'étude INERIS N° DRC-13-136338-06193C
Guide de surveillance de l'impact sur l'environnement des émissions atmosphériques des installations d'incinération et de co-incinération de déchets non dangereux et de déchets d'activités de soins à risques infectieux

Le taux d'exposition a alors été calculé de la façon suivante :

$$\text{Taux d'exposition /point de prélèvement (\%)} = \frac{\sum \text{heures sous le vent}}{\text{durée d'échantillonnage}} \times 100$$

Durées d'échantillonnage :

/// environ 840 h (correspondant à 1 mois d'exposition) pour les retombées atmosphériques.

Pour qu'un échantillon soit jugé significativement exposé aux rejets d'un émetteur, le taux d'exposition doit être de l'ordre de 15 à 20 % (expérience LECES). Par comparaison, pour les mesures de retombées de dioxines et furanes, l'INERIS⁴ préconise qu'un point de mesure soit au moins 25 % du temps sous les vents de l'émetteur ciblé afin qu'on puisse parler d'impact significatif.

La rose des vents correspondant aux directions et vitesses de vent observées du 25 octobre au 29 novembre 2019 est présentée dans la figure 1 ci-dessous.

Figure 1. - Rose des vents sur la période de mesures

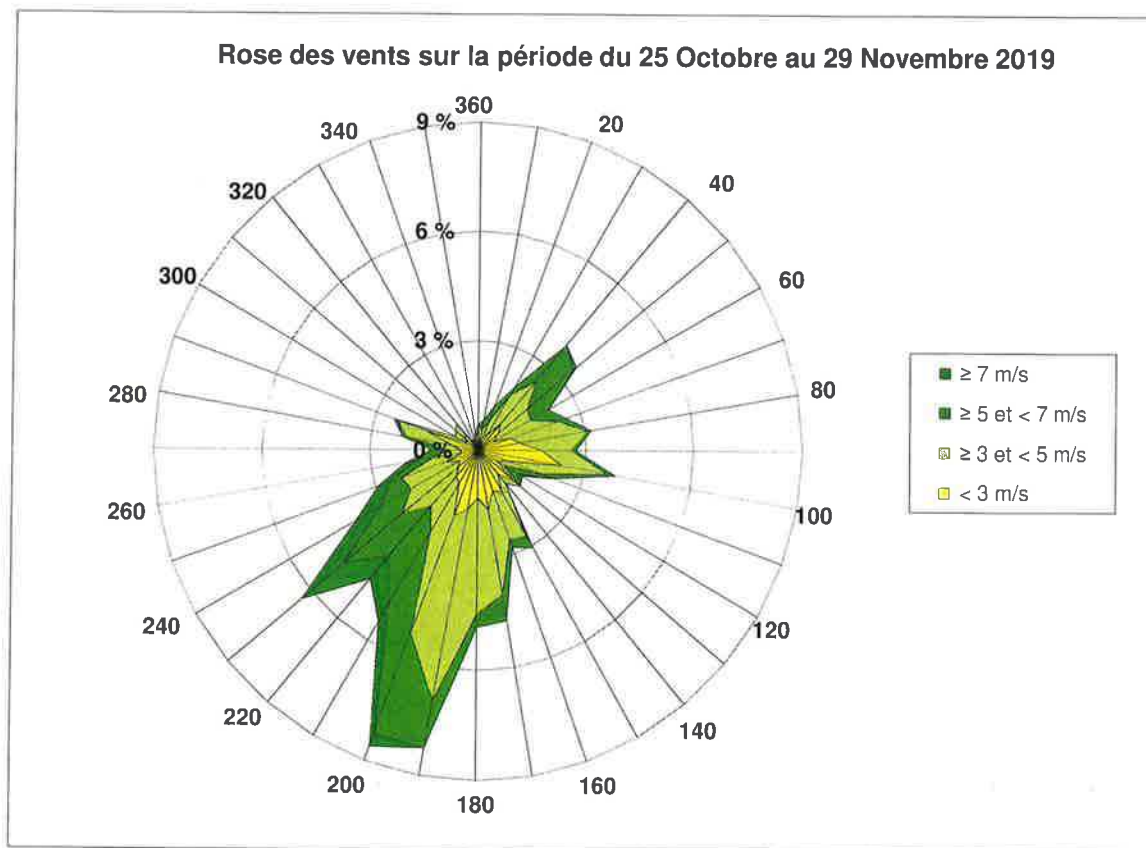

⁴ M. DURIF - Rapport final INERIS MATE/SEI -DRC - 01- 25585 - AIRE - n°716 -1^{er} décembre 2001
Méthode de surveillance des retombées des dioxines et furanes autour de VALO'MARNE

4 RÉSULTATS

4.1 RETOMBÉES ATMOSPHERIQUES ET DEPOTS DE METAUX

Les mesures de retombées atmosphériques aux six points de surveillance ont été effectuées du 25 octobre au 29 novembre 2019. La rose des vents correspondant à la période d'exposition des collecteurs de précipitation est présentée en figure dans l'annexe 2.

Sur la période d'observation des retombées de poussières, les différents points de surveillance ont été relativement peu exposés sous les vents de VALO'MARNE de Créteil pour les points 3, 4 et 5 (de 4% à 10%), modérément exposés pour le point 2 et 6 (de 14% à 19% du temps), très exposés pour le point 1 (27% du temps)

Pendant cette période, les vitesses de vent étaient modérées, la plupart du temps entre 3 et 5 m/s (43% du temps). Les vents ont soufflé :





- /// de secteur Nord-Est à Est 22 % du temps,
- /// de secteur Sud-Est à Ouest-Sud-Ouest durant 51 % du temps.

Les résultats des mesures de retombées de poussières sont regroupés dans le tableau 5. Dans ce tableau figurent également les pourcentages de temps pendant lesquels les points de mesure étaient sous les vents des émissions de VALO'MARNE.

Tableau 5. - Retombées atmosphériques (mg/m²/jour) et dépôts de métaux (µg/m²/jour)

	Point 1 Palais des sports	Point 2 Hôpital	Point 3 Mairie de Choisy	Point 4 Sita IDF	Point 5 Mairie Créteil	Point 6 Centre culturel	Valeurs de référence ⁵	Valeurs indicative
Poussières sédimentables	59	191	222	85	350	194	350	-
Chrome	0.70	0.63	0.69	2.23	2.10	0.81	-	3,6
Manganèse	8	10	7	16	18	9	-	64
Cobalt	0,09	0,16	0,13	0,37	0,23	0,14	-	-
Nickel	0.61	12.95	9.16	2,84	1,74	0.95	15	5
Cuivre	13.71	11.42	13.16	16.60	22.12	17.72	-	-
Zinc	48.40	38.29	37.53	186.12	105.17	45.51	400	-
Arsenic	0.09	0,13	0,14	0,32	0,23	0,18	4	-
Cadmium	0,15	0,25	0,11	0,21	0,23	0,17	2	-
Etain	0.44	0,41	0.82	0.45	1.41	0.48	-	-
Thallium	0,03	0,05	0,03	0,14	0,05	0,03	-	-
Plomb	4.76	7.46	3.45	28.68	7.21	5.52	100	10
Mercuré	0,01	0,01	0,02	0,01	0,01	0,01	1	-
Taux d'exposition moyen (%)	27	19	7	4	6	14		

⁵ Valeurs allemandes et suisses (pour le zinc) en l'absence de réglementation en FRANCE :
Instruction technique sur la qualité de l'air TA Luft - 24 juillet 2002 (ALLEMAGNE)
Annexe 7 de l'ordonnance sur la protection de l'air (OPair) - en vigueur depuis le 16 novembre 2015 (SUISSE)

-  Satisfaisant : Concentration inférieure à la valeur de référence ou indicative la plus basse
-  Tolérable : Dépassement de la valeur indicative mais non dépassement de la valeur de référence si existante
-  Non satisfaisant : Dépassement de la valeur de référence
-  Absence de valeur de référence, concentration donnée à titre indicative.

Commentaires

- /// les niveaux de retombées de poussières sont hétérogènes, variant de 59 mg/m²/jour (POINT 1 PALAIS DES SPORTS) à 350 mg/m²/jour (POINT 5 MAIRIE DE CRETEIL) ; ils sont cependant tous inférieurs ou égales à la valeur de référence de 350 mg/m²/jour,
- /// les niveaux de retombées ou de métaux observés à proximité de VALO'MARNE varient différemment selon le niveau d'exposition. Ils sont peu corrélés au taux d'exposition sous les vents de VALO'MARNE,
- /// **les valeurs relevées sur le point 5 (MAIRIE DE CRETEIL) ne peuvent être imputées à VALO'MARNE de Créteil du fait d'un taux d'exposition faible (6%, sous les vents) ; ces valeurs laissent supposer la proximité d'autres activités émettrices de poussières qui perturberaient potentiellement la surveillance environnementale engagée**

4.2 PCDD/FET PBDD/F DANS LES RETOMBÉES DE POUSSIÈRES



Les mesures ont été réalisées sur la même période de surveillance que les mesures de métaux dans les retombées de poussières.

4.2.1 POLYCHLORODIBENZODIOXINES ET POLYCHLORODIBENZOFURANNES DANS LES RETOMBÉES DE POUSSIÈRES

Les résultats d'analyse des PCDD et PCDF dans les retombées de poussières sont regroupés dans le tableau 6. Dans ce tableau figurent également les pourcentages de temps pour lesquels les points de mesure étaient sous les vents des émissions de VALO'MARNE.

Tableau 6. - Concentrations pondérées en PCDD/PCDF dans les retombées de poussières (pg_{OMS-TEQ}/m²/jour⁶)

PCDD - PCDF	Point 1	Point 2	Point 3	Point 4	Point 5	Point 6
(pg/m ² /jour - f-TEQ _{OMS 2005})						
2,3,7,8 TCDD	< 0,1452	< 0,1453	< 0,1453	< 0,1450	< 0,1451	< 0,1450
1,2,3,7,8PeCDD	< 0,2904	< 0,2905	< 0,2906	< 0,2901	< 0,2901	< 0,2900
1,2,3,4,7,8HxCDD	< 0,0290	< 0,0291	< 0,0291	< 0,0290	< 0,0290	< 0,0290
1,2,3,6,7,8HxCDD	< 0,0521	< 0,0840	< 0,0291	< 0,0290	< 0,0290	< 0,0290
1,2,3,7,8,9HxCDD	< 0,0290	< 0,0566	< 0,0291	< 0,0697	< 0,0290	< 0,0853
1,2,3,4,6,7,8HpCDD	< 0,0743	< 0,0958	< 0,0293	< 0,1136	< 0,1462	< 0,1142
OCDD	< 0,0054	< 0,0094	< 0,0021	< 0,0092	< 0,0111	< 0,0078
2,3,7,8 TCDF	< 0,0145	< 0,0145	< 0,0145	< 0,0145	< 0,0145	< 0,0145
1,2,3,7,8PeCDF	< 0,0087	< 0,0087	< 0,0087	< 0,0087	< 0,0087	< 0,0087
2,3,4,7,8PeCDF	< 0,0871	< 0,0872	< 0,0872	< 0,0870	< 0,0870	< 0,0870
1,2,3,4,7,8HxCDF	< 0,0290	< 0,0291	< 0,0291	< 0,0290	< 0,0290	< 0,0402
1,2,3,6,7,8HxCDF	< 0,0290	< 0,0291	< 0,0291	< 0,0290	< 0,0290	< 0,0290
2,3,4,6,7,8HxCDF	< 0,0290	< 0,0451	< 0,0291	< 0,0290	< 0,0290	< 0,0670
1,2,3,7,8,9HxCDF	< 0,0290	< 0,0291	< 0,0291	< 0,0290	< 0,0290	< 0,0290
1,2,3,4,6,7,8HpCDF	< 0,0120	< 0,0174	< 0,0058	< 0,0237	< 0,0289	< 0,0197
1,2,3,4,7,8,9HpCDF	< 0,0058	< 0,0058	< 0,0058	< 0,0058	< 0,0058	< 0,0058
Concentration mini PCDD/F⁷	0,354	0,396	0,648	0,376	0,216	0,307
Concentration maxi PCDD/F⁸	0,871	0,977	0,793	0,941	0,941	1,001
Taux d'exposition moyen (%)	27	19	7	4	6	14

	Satisfaisant : Concentration inférieure à la valeur de référence de 10 pg.m ⁻² .j ⁻¹
	Tolérable : Dépassement de la valeur de référence de 10 pg.m ⁻² .j ⁻¹ mais non dépassement de la valeur supérieure de l'intervalle de concentration typique de ce type d'installation de 85 pg.m ⁻² .j ⁻¹
	

⁶ **OMS-TEQ** : Toxic Equivalent Quantity de la nomenclature OMS - Résultat de la somme des concentrations pondérées des TEF (Facteurs d'Équivalence Toxique de certaines molécules) pour 7 congénères de PCDD (sur 75), 10 congénères de PCDF (sur 135) et 12 congénères de PCB (sur 209) assimilés aux dioxines (dits "dioxin-like") proposés par l'OMS en 1997 et réévalués en 2005

⁷ Concentrations minimales ou exclusives (concentrations en congénères non quantifiés, prises égales à zéro)

⁸ Concentrations maximales ou inclusives (concentrations en congénères non quantifiés, prises égales à la limite de quantification) dans le référentiel OMS 2005

Non satisfaisant : Dépassement de la valeur de référence de 10 pg.m⁻².j⁻¹ et de la valeur supérieure de l'intervalle de concentration typique de ce type d'installation de 85 pg.m⁻².j⁻¹

Commentaires

Les résultats d'analyses de PCDD et PCDF dans les retombées de poussières montrent que :

- /// Les concentrations en PCDD/F sont du même ordre de grandeur sur tous les points,
- /// La teneur la plus élevée a été observée au niveau du POINT 6 CENTRE CULTUREL (1,001pg/m²/jour) alors que la teneur la plus faible a été mesurée au niveau du POINT 3 Mairie de Choisy (0,793pg/m²/jour),
- /// Les teneurs en PCDD/F relevées sur les différents points sont relativement faibles, dans la gamme des concentrations de type rural.

4.2.2 POLYBROMODIBENZODIOXINES ET POLYBROMODIBENZOFURANNES DANS LES RETOMBÉES DE POUSSIÈRES

Les résultats d'analyse des PCDD et PCDF dans les retombées de poussières sont regroupés dans le tableau 7. Dans ce tableau figurent également les pourcentages de temps pour lesquels les points de mesure étaient sous les vents des émissions de VALO'MARNE.

Tableau 7. - Concentrations pondérées en PBDD/PBDF dans les retombées de poussières (pg/m²/jour⁹)

PBDD - PBDF (pg/m ² /jour -)	Point 1 Palais des sports	Point 2 Hôpital	Point 3 Mairie de Choisy	Point 4 Sita IDF	Point 5 Mairie Créteil	Point 6 Centre culturel
2,3,7,8 TBDD	< 2,3232	< 2,3232	< 2,3232	< 2,3232	< 2,3232	< 2,3232
1,2,3,7,8PeBDD	< 2,3232	< 2,3232	< 2,3232	< 2,3232	< 2,3232	< 2,3232
1,2,3,4,7,8 + 1,2,3,6,7,8 HxBDD	< 6,9697	< 6,9697	< 6,9697	< 6,9697	< 6,9697	< 6,9697
1,2,3,7,8,9HxBDD	< 6,9697	< 6,9697	< 6,9697	< 6,9697	< 6,9697	< 6,9697
1,2,3,4,6,7,8HpBDD	< 9,2929	< 9,2929	< 9,2929	< 9,2929	< 9,2929	< 9,2929
OBDD	< 11,6162	< 11,6162	< 11,6162	< 11,6162	< 11,6162	< 11,6162
2,4,7,8 TBDF	< 2,3232	11,13	< 2,3232	< 2,3232	< 2,3232	17,97
2,3,7,8 TBDF	< 2,3232	< 2,3232	< 2,3232	< 2,3232	< 2,3232	< 2,3232
1,2,3,7,8PeBDF	< 4,6465	< 4,6465	< 4,6465	< 4,6465	< 4,6465	< 4,6465
2,3,4,7,8PeBDF	< 4,6465	< 4,6465	< 4,6465	< 4,6465	< 4,6465	< 4,6465
1,2,3,4,7,8HxBDF	< 6,9697	< 6,9697	< 6,9697	< 6,9697	< 6,9697	< 6,9697
1,2,3,4,6,7,8HpBDF	< 9,2929	< 9,2929	< 9,2929	452,82	< 9,2929	98,73
OBDF	< 46,4646	< 46,4646	< 46,4646	< 46,4646	174,28	< 46,4646

⁹ **OMS-TEQ** : Toxic Equivalent Quantity de la nomenclature OMS - Résultat de la somme des concentrations pondérées des TEF (Facteurs d'Équivalence Toxique de certaines molécules) pour 7 congénères de PCDD (sur 75), 10 congénères de PCDF (sur 135) et 12 congénères de PCB (sur 209) assimilés aux dioxines (dits "dioxin-like") proposés par l'OMS en 1997 et réévalués en 2005

5 CONCLUSION

Dans le cadre du plan de surveillance environnemental, une campagne de caractérisation de la qualité de l'air (campagne d'hiver) a été réalisée entre octobre et novembre 2019 dans l'environnement de VALO'MARNE de Créteil. Les enseignements tirés de ces mesures sont résumés ci-après :

RETOMBÉES ATMOSPHERIQUES ET DEPOTS DE METAUX

- /// les retombées de poussières sont assez hétérogènes sur l'ensemble des six points de mesure mais sont toutes inférieures ou égales à la valeur de référence de 350 mg/m²/jour,
- /// les niveaux de retombées ou de métaux observés à proximité de VALO'MARNE varient différemment selon le niveau d'exposition. Ils sont peu corrélés au taux d'exposition sous les vents de VALO'MARNE,
- /// le POINT 5 présente des valeurs en poussières et en métaux plus élevées que les autres points, mais elles ne peuvent pas être reliées à l'activité de VALO'MARNE.

Les concentrations mesurées dans l'environnement de VALO'MARNE ne mettent pas en évidence d'impact industriel sur les concentrations en métaux dans les retombées de poussières. La poursuite de la surveillance actuelle est tout de même recommandée afin d'affiner les performances environnementales de la société VALO'MARNE et de préciser l'impact réel de l'usine dans le voisinage.

PCDD - PCDF DANS LES RETOMBÉES DE POUSSIÈRES

- /// Les concentrations en PCDD/F sont du même ordre de grandeur sur tous les points,
- /// Les teneurs en PCDD/F relevées sur les différents points sont relativement faibles, dans la gamme des concentrations de type rural.

Les concentrations mesurées dans l'environnement de VALO'MARNE ne mettent pas en évidence d'impact industriel sur les concentrations en PCDD/F dans les retombées de poussières.

ooo

ANNEXES

ANNEXE 1

POSITION DES POINTS DE MESURE

Localisation du site VALO'MARNE et des points de mesure

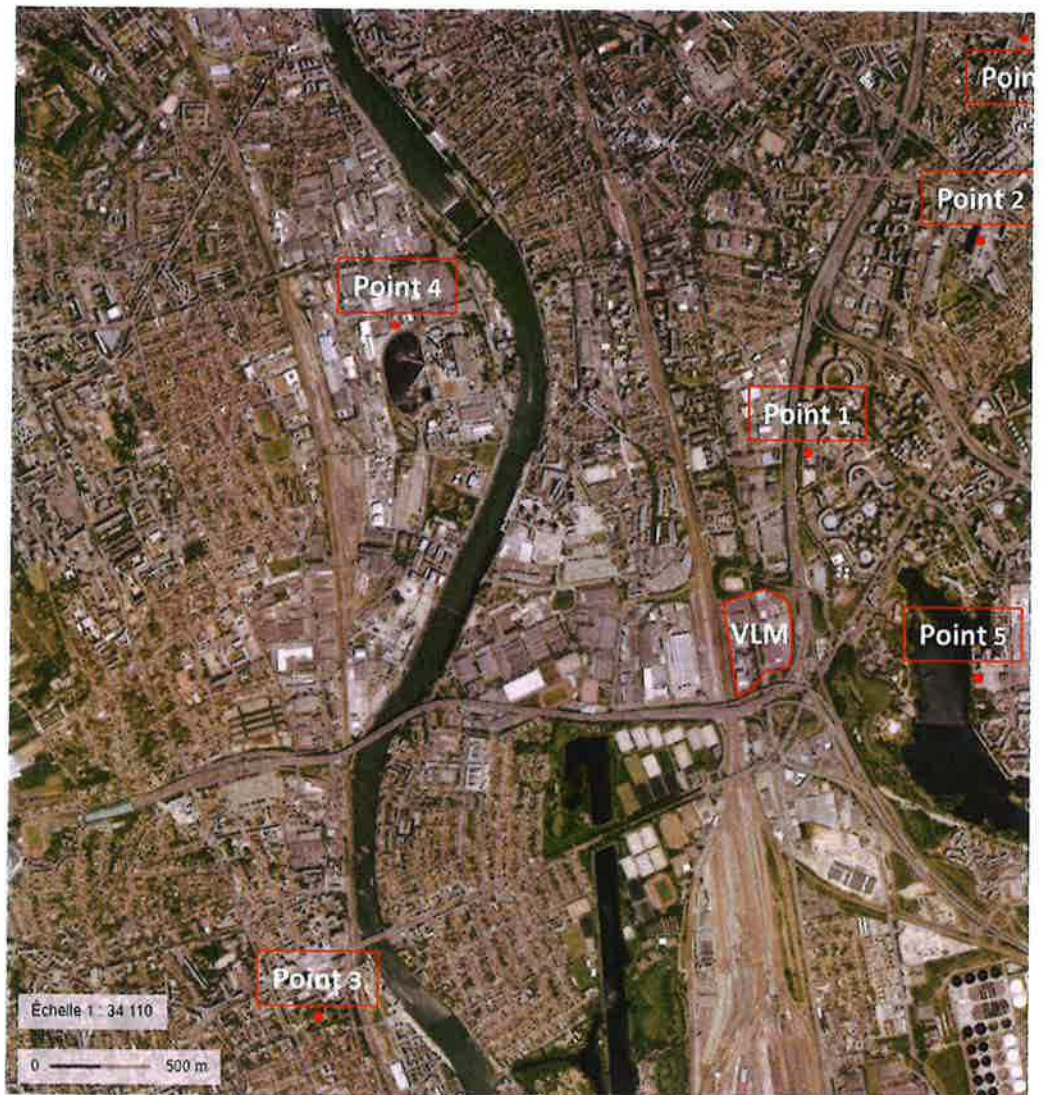

RC 33233

ANNEXE 2

**ROSE DES VENTS CORRESPONDANT
A LA PERIODE DE MESURE**

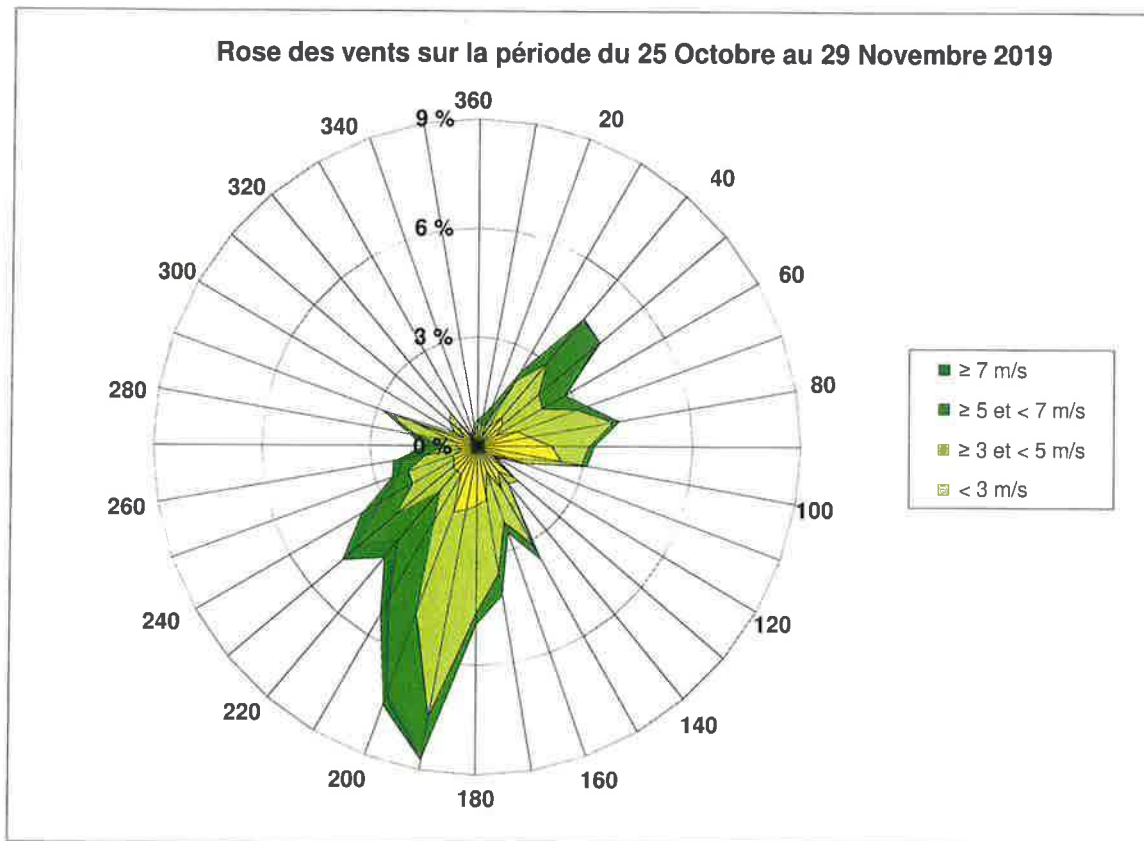

ANNEXE 3

**EVOLUTION DES DEPOTS ATMOSPHERIQUES
DEPUIS 2011**

Suivi de l'évolution des dépôts atmosphériques en PCDD/PCDF de 2011 à 2019

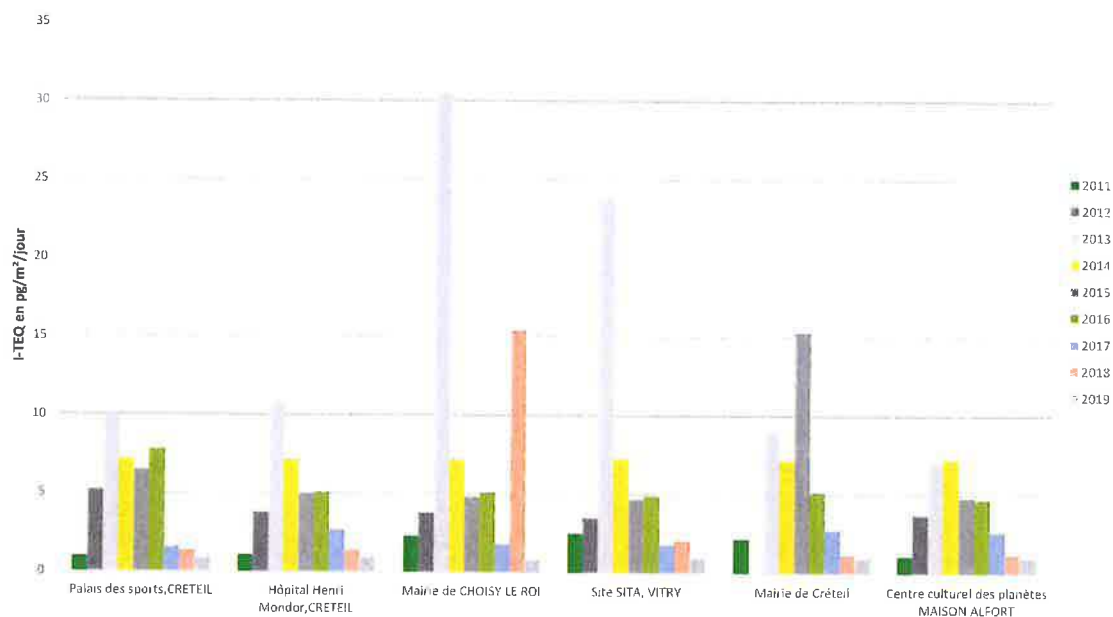

Suivi de l'évolution des dépôts atmosphériques en Cadmium de 2011 à 2019

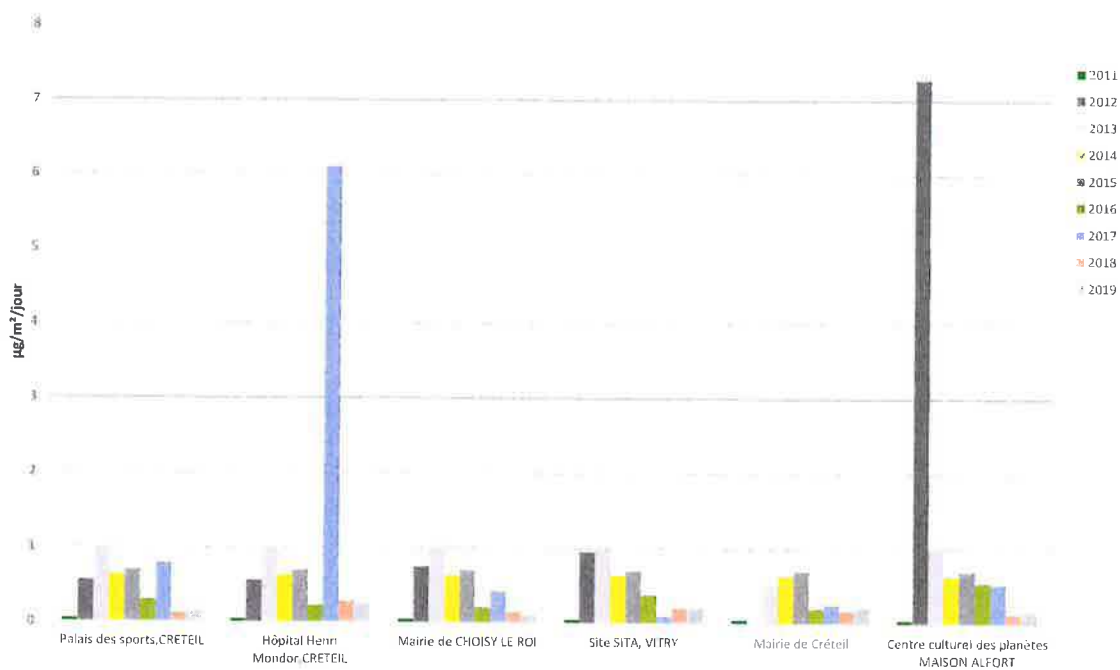

Suivi de l'évolution des dépôts atmosphériques en Chrome de 2011 à 2019

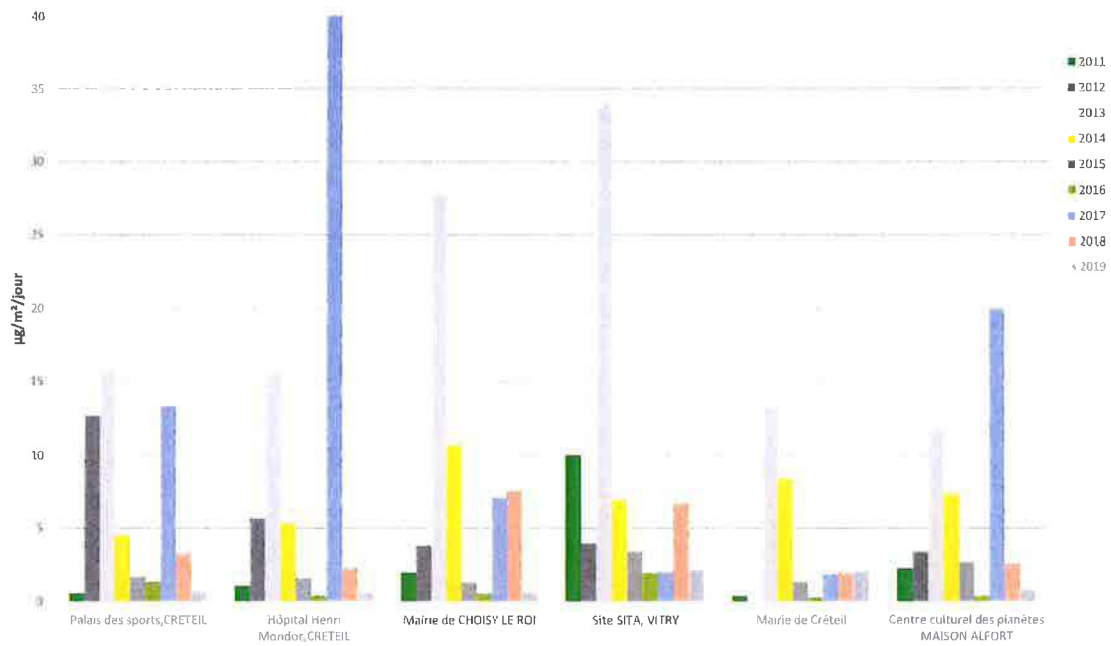

Suivi de l'évolution des dépôts atmosphériques en Manganèse de 2011 à 2019

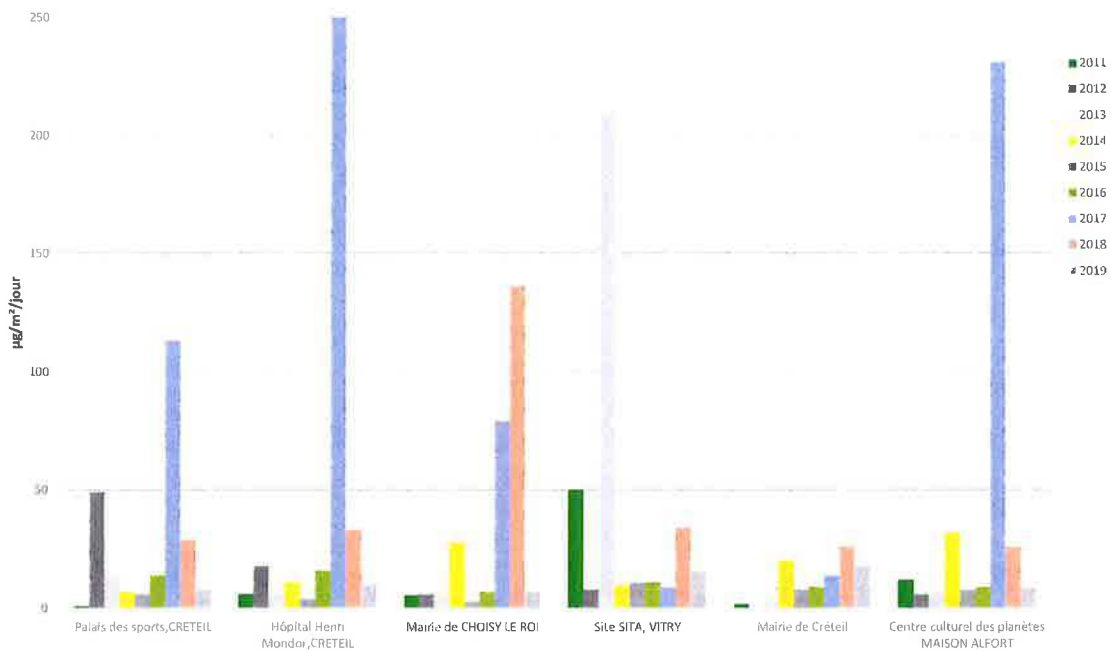

Suivi de l'évolution des dépôts atmosphériques en Nickel de 2011 à 2019

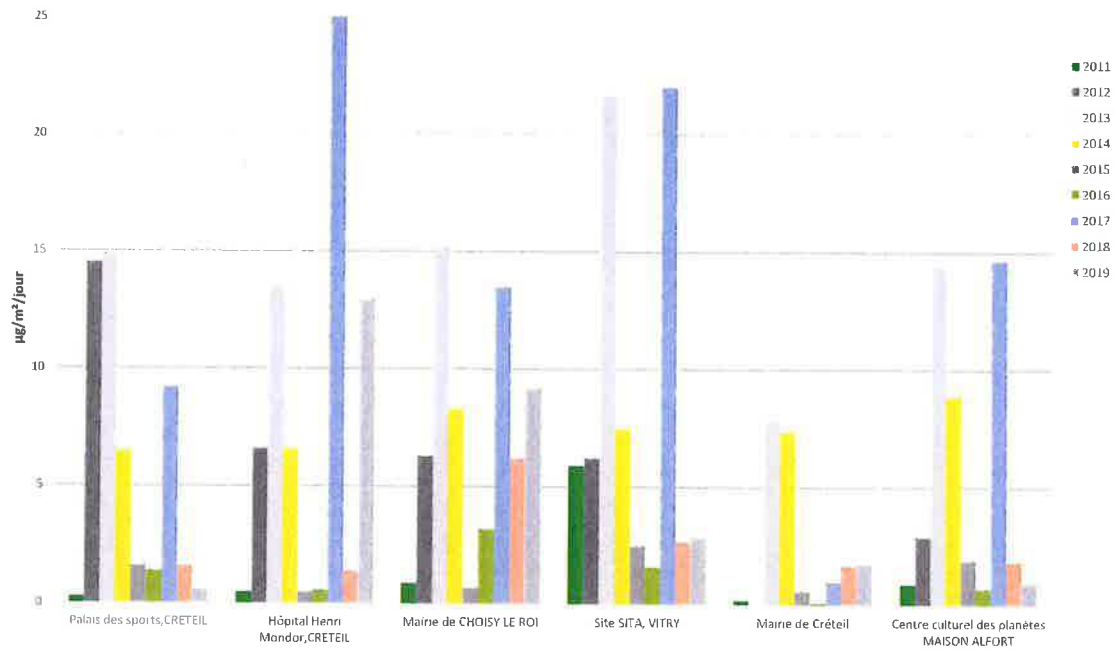

Suivi de l'évolution des dépôts atmosphériques en Plomb de 2011 à 2019

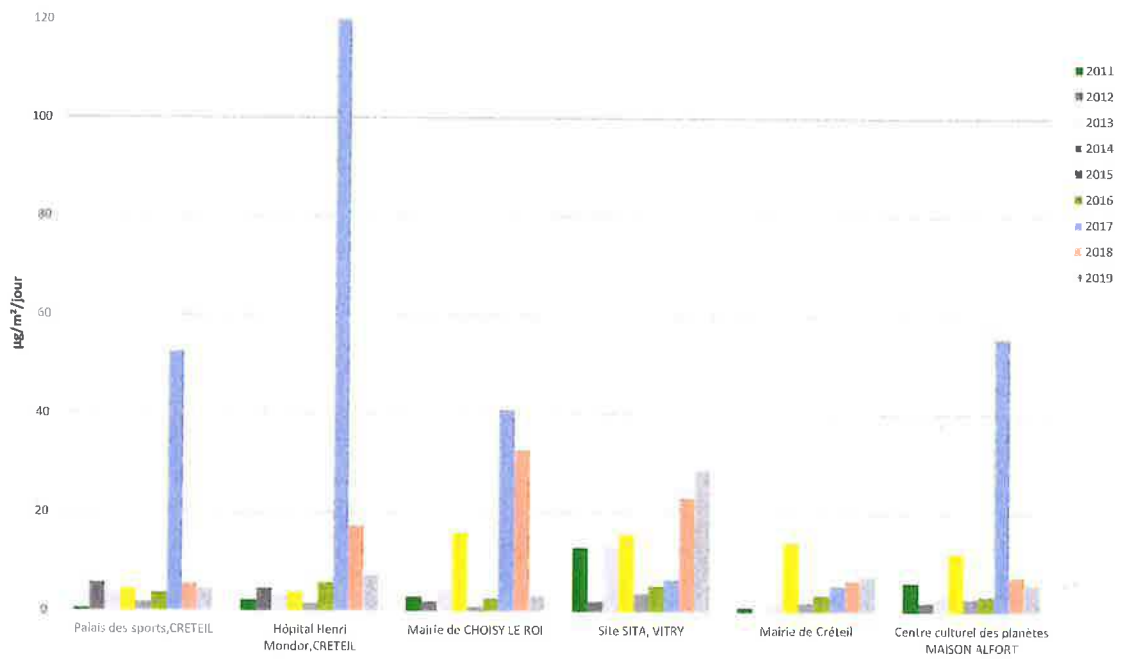

Suivi de l'évolution des dépôts atmosphériques en Hg de 2011 à 2019

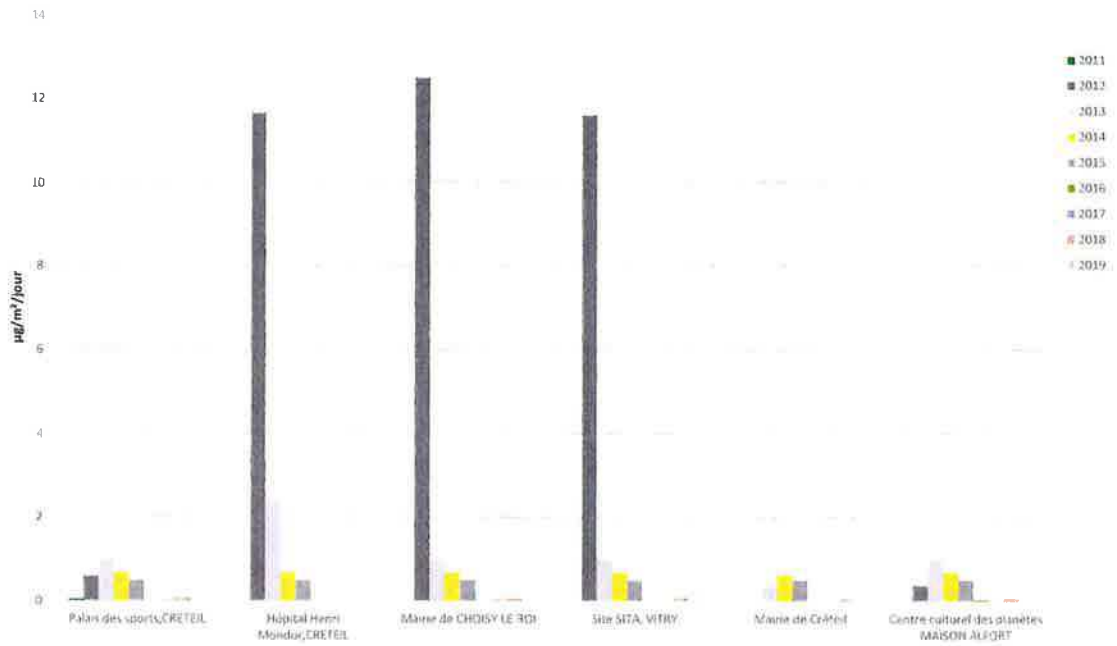

Suivi de l'évolution des dépôts atmosphériques en Thallium de 2011 à 2019

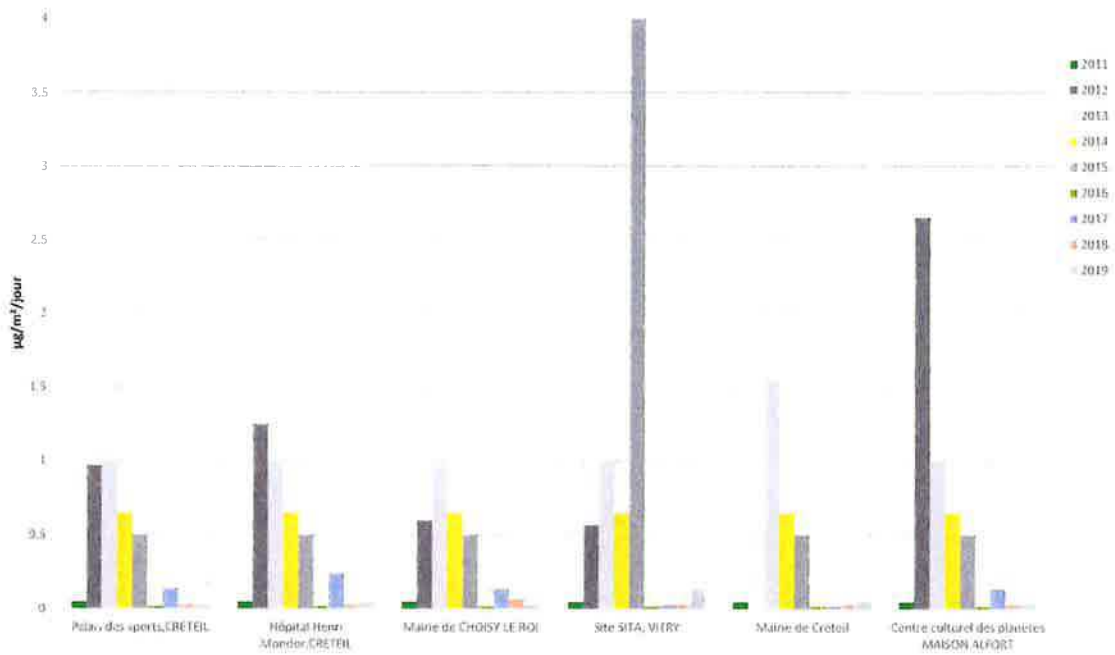

Suivi de l'évolution des dépôts atmosphériques en Cobalt de 2011 à 2019

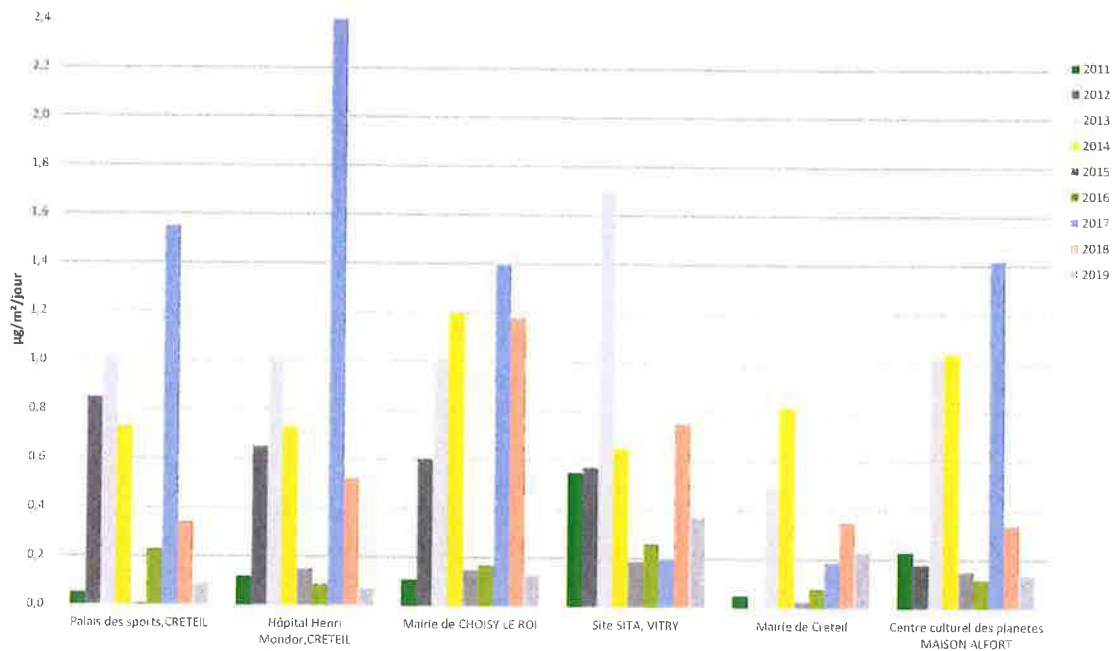

Suivi de l'évolution des dépôts atmosphériques en Cuivre de 2011 à 2019

